



Cisco Security Appliance Command Line Configuration Guide

For the Cisco ASA 5500 Series and Cisco PIX 500 Series

Software Version 7.0(4)

Corporate Headquarters

Cisco Systems, Inc.
170 West Tasman Drive
San Jose, CA 95134-1706
USA
<http://www.cisco.com>
Tel: 408 526-4000
800 553-NETS (6387)
Fax: 408 526-4100

Customer Order Number: N/A, Online only
Text Part Number: OL-6721-02



THE SPECIFICATIONS AND INFORMATION REGARDING THE PRODUCTS IN THIS MANUAL ARE SUBJECT TO CHANGE WITHOUT NOTICE. ALL STATEMENTS, INFORMATION, AND RECOMMENDATIONS IN THIS MANUAL ARE BELIEVED TO BE ACCURATE BUT ARE PRESENTED WITHOUT WARRANTY OF ANY KIND, EXPRESS OR IMPLIED. USERS MUST TAKE FULL RESPONSIBILITY FOR THEIR APPLICATION OF ANY PRODUCTS.

THE SOFTWARE LICENSE AND LIMITED WARRANTY FOR THE ACCOMPANYING PRODUCT ARE SET FORTH IN THE INFORMATION PACKET THAT SHIPPED WITH THE PRODUCT AND ARE INCORPORATED HEREIN BY THIS REFERENCE. IF YOU ARE UNABLE TO LOCATE THE SOFTWARE LICENSE OR LIMITED WARRANTY, CONTACT YOUR CISCO REPRESENTATIVE FOR A COPY.

The Cisco implementation of TCP header compression is an adaptation of a program developed by the University of California, Berkeley (UCB) as part of UCB's public domain version of the UNIX operating system. All rights reserved. Copyright © 1981, Regents of the University of California.

NOTWITHSTANDING ANY OTHER WARRANTY HEREIN, ALL DOCUMENT FILES AND SOFTWARE OF THESE SUPPLIERS ARE PROVIDED "AS IS" WITH ALL FAULTS. CISCO AND THE ABOVE-NAMED SUPPLIERS DISCLAIM ALL WARRANTIES, EXPRESSED OR IMPLIED, INCLUDING, WITHOUT LIMITATION, THOSE OF MERCHANTABILITY, FITNESS FOR A PARTICULAR PURPOSE AND NONINFRINGEMENT OR ARISING FROM A COURSE OF DEALING, USAGE, OR TRADE PRACTICE.

IN NO EVENT SHALL CISCO OR ITS SUPPLIERS BE LIABLE FOR ANY INDIRECT, SPECIAL, CONSEQUENTIAL, OR INCIDENTAL DAMAGES, INCLUDING, WITHOUT LIMITATION, LOST PROFITS OR LOSS OR DAMAGE TO DATA ARISING OUT OF THE USE OR INABILITY TO USE THIS MANUAL, EVEN IF CISCO OR ITS SUPPLIERS HAVE BEEN ADVISED OF THE POSSIBILITY OF SUCH DAMAGES.

CCSP, CCVP, the Cisco Square Bridge logo, Follow Me Browsing, and StackWise are trademarks of Cisco Systems, Inc.; Changing the Way We Work, Live, Play, and Learn, and iQuick Study are service marks of Cisco Systems, Inc.; and Access Registrar, Aironet, BPX, Catalyst, CCDA, CCDP, CCIE, CCIP, CCNA, CCNP, Cisco, the Cisco Certified Internetwork Expert logo, Cisco IOS, Cisco Press, Cisco Systems, Cisco Systems Capital, the Cisco Systems logo, Cisco Unity, Enterprise/Solver, EtherChannel, EtherFast, EtherSwitch, Fast Step, FormShare, GigaDrive, GigaStack, HomeLink, Internet Quotient, IOS, IP/TV, iQ Expertise, the iQ logo, iQ Net Readiness Scorecard, LightStream, Linksys, MeetingPlace, MGX, the Networkers logo, Networking Academy, Network Registrar, Packet, PIX, Post-Routing, Pre-Routing, ProConnect, RateMUX, ScriptShare, SlideCast, SMARTnet, The Fastest Way to Increase Your Internet Quotient, and TransPath are registered trademarks of Cisco Systems, Inc. and/or its affiliates in the United States and certain other countries.

All other trademarks mentioned in this document or Website are the property of their respective owners. The use of the word partner does not imply a partnership relationship between Cisco and any other company. (0601R)

Cisco Security Appliance Command Line Configuration Guide
Copyright © 2005 Cisco Systems, Inc. All rights reserved.



About This Guide	25
Document Objectives	25
Audience	25
Related Documentation	26
Document Organization	26
Document Conventions	28
Obtaining Documentation	29
Cisco.com	29
Ordering Documentation	29
Documentation Feedback	29
Obtaining Technical Assistance	30
Cisco Technical Support Website	30
Submitting a Service Request	30
Definitions of Service Request Severity	31
Obtaining Additional Publications and Information	31

PART 1

Getting Started and General Information

CHAPTER 1

Introduction to the Security Appliance 1

Firewall Functional Overview	1
Security Policy Overview	2
Permitting or Denying Traffic with Access Lists	2
Applying NAT	2
Using AAA for Through Traffic	2
Applying HTTP, HTTPS, or FTP Filtering	3
Applying Application Inspection	3
Sending Traffic to the Advanced Inspection and Prevention Security Services Module	3
Applying QoS Policies	3
Applying Connection Limits and TCP Normalization	3
Firewall Mode Overview	3
Stateful Inspection Overview	4
VPN Functional Overview	5
Intrusion Prevention Services Functional Overview	5
Security Context Overview	5

CHAPTER 2

Getting Started 1

- Accessing the Command-Line Interface 1
- Setting Transparent or Routed Firewall Mode 2
- Working with the Configuration 3
 - Saving Configuration Changes 3
 - Viewing the Configuration 3
 - Clearing and Removing Configuration Settings 4
 - Creating Text Configuration Files Offline 4

CHAPTER 3

Enabling Multiple Context Mode 1

- Security Context Overview 1
 - Common Uses for Security Contexts 2
 - Unsupported Features 2
 - Context Configuration Files 2
 - How the Security Appliance Classifies Packets 3
 - Sharing Interfaces Between Contexts 6
 - Shared Interface Guidelines 7
 - Cascading Security Contexts 9
 - Logging into the Security Appliance in Multiple Context Mode 10
- Enabling or Disabling Multiple Context Mode 10
 - Backing Up the Single Mode Configuration 10
 - Enabling Multiple Context Mode 10
 - Restoring Single Context Mode 11

CHAPTER 4

Configuring Ethernet Settings and Subinterfaces 1

- Configuring and Enabling RJ-45 Interfaces 1
- Configuring and Enabling Fiber Interfaces on the 4GE SSM 2
- Configuring and Enabling Subinterfaces 3

CHAPTER 5

Adding and Managing Security Contexts 1

- Configuring a Security Context 1
- Removing a Security Context 5
- Changing the Admin Context 5
- Changing Between Contexts and the System Execution Space 5
- Changing the Security Context URL 6
- Reloading a Security Context 7
 - Reloading by Clearing the Configuration 7
 - Reloading by Removing and Re-adding the Context 7

Monitoring Security Contexts	8
Viewing Context Information	8
Viewing Resource Usage	9

CHAPTER 6

Configuring Interface Parameters	1
Security Level Overview	1
Configuring the Interface	2
Allowing Communication Between Interfaces on the Same Security Level	5

CHAPTER 7

Configuring Basic Settings	1
Changing the Enable Password	1
Setting the Hostname	2
Setting the Domain Name	2
Setting the Date and Time	2
Setting the Time Zone and Daylight Saving Time Date Range	3
Setting the Date and Time Using an NTP Server	4
Setting the Date and Time Manually	4
Setting the Management IP Address for a Transparent Firewall	5

CHAPTER 8

Configuring IP Routing and DHCP Services	1
Configuring Static and Default Routes	1
Configuring a Static Route	2
Configuring a Default Route	3
Configuring OSPF	3
OSPF Overview	4
Enabling OSPF	5
Redistributing Routes Between OSPF Processes	5
Adding a Route Map	7
Redistributing Static, Connected, or OSPF Routes to an OSPF Process	8
Configuring OSPF Interface Parameters	9
Configuring OSPF Area Parameters	11
Configuring OSPF NSSA	12
Configuring Route Summarization Between OSPF Areas	13
Configuring Route Summarization When Redistributing Routes into OSPF	13
Generating a Default Route	14
Configuring Route Calculation Timers	14
Logging Neighbors Going Up or Down	15
Displaying OSPF Update Packet Pacing	15

- Monitoring OSPF 16
 - Restarting the OSPF Process 16
- Configuring RIP 17
 - RIP Overview 17
 - Enabling RIP 17
- Dynamic Routing and Failover 18
- Configuring Multicast Routing 18
 - Multicast Routing Overview 18
 - Enabling Multicast Routing 19
 - Configuring IGMP Features 19
 - Disabling IGMP on an Interface 20
 - Configuring Group Membership 20
 - Configuring a Statically Joined Group 20
 - Controlling Access to Multicast Groups 20
 - Limiting the Number of IGMP States on an Interface 21
 - Modifying the Query Interval and Query Timeout 21
 - Changing the Query Response Time 22
 - Changing the IGMP Version 22
 - Configuring Stub Multicast Routing 22
 - Configuring a Static Multicast Route 22
 - Configuring PIM Features 23
 - Disabling PIM on an Interface 23
 - Configuring a Static Rendezvous Point Address 23
 - Configuring the Designated Router Priority 24
 - Filtering PIM Register Messages 24
 - Configuring PIM Message Intervals 24
 - For More Information about Multicast Routing 25
- Configuring DHCP 25
 - Configuring a DHCP Server 25
 - Enabling the DHCP Server 25
 - Configuring DHCP Options 27
 - Using Cisco IP Phones with a DHCP Server 27
 - Configuring DHCP Relay Services 28
 - Configuring the DHCP Client 29

CHAPTER 9

Configuring IPv6 1

- IPv6-enabled Commands 1
- Configuring IPv6 on an Interface 2
- Configuring IPv6 Default and Static Routes 3

Configuring IPv6 Access Lists	4
Verifying the IPv6 Configuration	5
The show ipv6 interface Command	5
The show ipv6 route Command	6
Configuring a Dual IP Stack on an Interface	6
IPv6 Configuration Example	7

CHAPTER 10**Configuring AAA Servers and the Local Database 1**

AAA Overview	1
About Authentication	2
About Authorization	2
About Accounting	2
AAA Server and Local Database Support	3
Summary of Support	3
RADIUS Server Support	4
Authentication Methods	4
Attribute Support	4
RADIUS Functions	4
TACACS+ Server Support	5
SDI Server Support	6
SDI Version Support	6
Two-step Authentication Process	7
SDI Primary and Replica Servers	7
NT Server Support	7
Kerberos Server Support	7
LDAP Server Support	8
Local Database Support	8
User Profiles	8
Local Database Functions	8
Fallback Support	9
Configuring the Local Database	9
Identifying AAA Server Groups and Servers	11

CHAPTER 11**Configuring Failover 1**

Understanding Failover	1
Failover System Requirements	2
Hardware Requirements	2
Software Requirements	2
License Requirements	2

- The Failover and Stateful Failover Links 3
 - Failover Link 3
 - Stateful Failover Link 5
- Active/Active and Active/Standby Failover 6
 - Active/Standby Failover 6
 - Active/Active Failover 9
 - Determining Which Type of Failover to Use 13
- Regular and Stateful Failover 14
 - Regular Failover 14
 - Stateful Failover 14
- Failover Health Monitoring 15
 - Unit Health Monitoring 15
 - Interface Monitoring 15
- Configuring Failover 16
 - Configuring Active/Standby Failover 16
 - Prerequisites 16
 - Configuring Cable-Based Active/Standby Failover (PIX Security Appliance Only) 17
 - Configuring LAN-Based Active/Standby Failover 18
 - Configuring Optional Active/Standby Failover Settings 21
 - Configuring Active/Active Failover 24
 - Prerequisites 24
 - Configuring Cable-Based Active/Active Failover (PIX security appliance Only) 24
 - Configuring LAN-Based Active/Active Failover 26
 - Configuring Optional Active/Active Failover Settings 29
 - Configuring Failover Communication Authentication/Encryption 35
 - Verifying the Failover Configuration 35
 - Using the show failover Command 36
 - Viewing Monitored Interfaces 44
 - Displaying the Failover Commands in the Running Configuration 44
 - Testing the Failover Functionality 44
- Controlling and Monitoring Failover 45
 - Forcing Failover 45
 - Disabling Failover 46
 - Restoring a Failed Unit or Failover Group 46
 - Monitoring Failover 46
 - Failover System Messages 46
 - Debug Messages 47
 - SNMP 47
- Failover Configuration Examples 47

Cable-Based Active/Standby Failover Example	48
LAN-Based Active/Standby Failover Example	49
LAN-Based Active/Active Failover Example	51

PART 2**Configuring the Firewall****CHAPTER 12****Firewall Mode Overview 1**

Routed Mode Overview	1
IP Routing Support	2
Network Address Translation	2
How Data Moves Through the Security Appliance in Routed Firewall Mode	3
An Inside User Visits a Web Server	4
An Outside User Visits a Web Server on the DMZ	5
An Inside User Visits a Web Server on the DMZ	6
An Outside User Attempts to Access an Inside Host	7
A DMZ User Attempts to Access an Inside Host	8
Transparent Mode Overview	8
Transparent Firewall Features	9
Using the Transparent Firewall in Your Network	10
Transparent Firewall Guidelines	10
Unsupported Features in Transparent Mode	11
How Data Moves Through the Transparent Firewall	12
An Inside User Visits a Web Server	13
An Outside User Visits a Web Server on the Inside Network	14
An Outside User Attempts to Access an Inside Host	15

CHAPTER 13**Identifying Traffic with Access Lists 1**

Access List Overview	1
Access List Types	2
Access Control Entry Order	2
Access Control Implicit Deny	3
IP Addresses Used for Access Lists When You Use NAT	3
Adding an Extended Access List	5
Extended Access List Overview	5
Allowing Special IP Traffic through the Transparent Firewall	5
Adding an Extended ACE	6
Adding an EtherType Access List	7
Adding a Standard Access List	9
Adding a Webtype Access List	10

- Simplifying Access Lists with Object Grouping 10
 - How Object Grouping Works 10
 - Adding Object Groups 11
 - Adding a Protocol Object Group 11
 - Adding a Network Object Group 12
 - Adding a Service Object Group 12
 - Adding an ICMP Type Object Group 13
 - Nesting Object Groups 14
 - Using Object Groups with an Access List 15
 - Displaying Object Groups 16
 - Removing Object Groups 16
- Adding Remarks to Access Lists 16
- Time Range Options 17
- Logging Access List Activity 17
 - Access List Logging Overview 17
 - Configuring Logging for an Access Control Entry 18
 - Managing Deny Flows 19

CHAPTER 14

Applying NAT 21

- NAT Overview 21
 - Introduction to NAT 22
 - NAT Control 23
 - NAT Types 25
 - Dynamic NAT 25
 - PAT 26
 - Static NAT 27
 - Static PAT 27
 - Bypassing NAT when NAT Control is Enabled 28
 - Policy NAT 29
 - NAT and Same Security Level Interfaces 33
 - Order of NAT Commands Used to Match Real Addresses 34
 - Mapped Address Guidelines 34
 - DNS and NAT 34
- Configuring NAT Control 36
- Using Dynamic NAT and PAT 37
 - Dynamic NAT and PAT Implementation 37
 - Configuring Dynamic NAT or PAT 43
- Using Static NAT 46
- Using Static PAT 47

Bypassing NAT	49
Configuring Identity NAT	49
Configuring Static Identity NAT	50
Configuring NAT Exemption	52
NAT Examples	53
Overlapping Networks	53
Redirecting Ports	55

CHAPTER 15**Permitting or Denying Network Access 1**

Inbound and Outbound Access List Overview	1
Applying an Access List to an Interface	2

CHAPTER 16**Applying AAA for Network Access 1**

AAA Performance	1
Configuring Authentication for Network Access	1
Authentication Overview	2
Enabling Network Access Authentication	3
Enabling Secure Authentication of Web Clients	4
Configuring Authorization for Network Access	6
Configuring TACACS+ Authorization	6
Configuring RADIUS Authorization	7
Configuring a RADIUS Server to Send Downloadable Access Control Lists	8
Configuring a RADIUS Server to Download Per-User Access Control List Names	11
Configuring Accounting for Network Access	12
Using MAC Addresses to Exempt Traffic from Authentication and Authorization	13

CHAPTER 17**Applying Filtering Services 1**

Filtering Overview	1
Filtering ActiveX Objects	2
Overview	2
Enabling ActiveX Filtering	2
Filtering Java Applets	3
Overview	3
Enabling Java Applet Filtering	3
Filtering with an External Server	4
Filtering Overview	4
General Procedure	5
Identifying the Filtering Server	5

- Buffering the Content Server Response 6
- Caching Server Addresses 7
- Filtering HTTP URLs 7
 - Configuring HTTP Filtering 7
 - Enabling Filtering of Long HTTP URLs 8
 - Truncating Long HTTP URLs 8
 - Exempting Traffic from Filtering 8
- Filtering HTTPS URLs 8
- Filtering FTP Requests 9
- Viewing Filtering Statistics and Configuration 10
 - Viewing Filtering Server Statistics 10
 - Viewing Buffer Configuration and Statistics 10
 - Viewing Caching Statistics 11
 - Viewing Filtering Performance Statistics 11
 - Viewing Filtering Configuration 12

CHAPTER 18

Using Modular Policy Framework 1

- Modular Policy Framework Overview 1
 - Default Global Policy 2
- Identifying Traffic Using a Class Map 2
- Defining Actions Using a Policy Map 4
 - Policy Map Overview 4
 - Default Policy Map 6
 - Adding a Policy Map 6
- Applying a Policy to an Interface Using a Service Policy 8
- Modular Policy Framework Examples 8
 - Applying Inspection and QoS Policing to HTTP Traffic 9
 - Applying Inspection to HTTP Traffic Globally 9
 - Applying Inspection and Connection Limits to HTTP Traffic to Specific Servers 10
 - Applying Inspection to HTTP Traffic with NAT 11

CHAPTER 19

Intercepting and Responding to Network Attacks 1

- Configuring the AIP SSM 1
 - Configuring the ASA 5500 to Divert Traffic to the AIP SSM 2
 - Sessioning to the AIP SSM and Running Setup 3
- Configuring IP Audit for Basic IPS Support 4
- Configuring TCP Normalization 4
- Protecting Your Network Against Specific Attacks 7

Preventing IP Spoofing	7
Configuring Connection Limits and Timeouts	9
Configuring the Fragment Size	10
Blocking Unwanted Connections	10

CHAPTER 20**Applying QoS Policies 1**

Overview	1
QoS Concepts	2
Implementing QoS	2
Identifying Traffic for QoS	4
Defining a QoS Policy Map	5
Applying Rate Limiting	6
Activating the Service Policy	7
Applying Low Latency Queueing	8
Configuring Priority Queueing	8
Sizing the Priority Queue	8
Reducing Queue Latency	9
Configuring QoS	9
Viewing QoS Configuration	12
Viewing QoS Service Policy Configuration	12
Viewing QoS Policy Map Configuration	13
Viewing the Priority-Queue Configuration for an Interface	13
Viewing QoS Statistics	13
Viewing QoS Police Statistics	14
Viewing QoS Priority Statistics	14
Viewing QoS Priority Queue Statistics	15

CHAPTER 21**Applying Application Layer Protocol Inspection 1**

Application Inspection Engines	1
Overview	2
How Inspection Engines Work	2
Supported Protocols	3
Applying Application Inspection to Selected Traffic	5
Overview	5
Identifying Traffic with a Traffic Class Map	6
Using an Application Inspection Map	8
Defining Actions with a Policy Map	9
Applying a Security Policy to an Interface	10

- Managing CTIQBE Inspection 10
 - CTIQBE Inspection Overview 10
 - Limitations and Restrictions 10
 - Enabling and Configuring CTIQBE Inspection 11
 - Verifying and Monitoring CTIQBE Inspection 13
- Managing DNS Inspection 14
 - How DNS Application Inspection Works 14
 - How DNS Rewrite Works 15
 - Configuring DNS Rewrite 16
 - Using the Alias Command for DNS Rewrite 17
 - Using the Static Command for DNS Rewrite 17
 - Configuring DNS Rewrite 17
 - DNS Rewrite with Three NAT Zones 18
 - Configuring DNS Rewrite with Three NAT Zones 19
 - Configuring DNS Inspection 20
 - Verifying and Monitoring DNS Inspection 21
- Managing FTP Inspection 22
 - FTP Inspection Overview 22
 - Using the **strict** Option 22
 - Configuring FTP Inspection 23
 - Verifying and Monitoring FTP Inspection 26
- Managing GTP Inspection 28
 - GTP Inspection Overview 28
 - Enabling and Configuring GTP Inspection 29
 - Enabling and Configuring GSN Pooling 32
 - Verifying and Monitoring GTP Inspection 34
- Managing H.323 Inspection 35
 - H.323 Inspection Overview 35
 - How H.323 Works 35
 - Limitations and Restrictions 37
 - Enabling and Configuring H.323 Inspection 37
 - Configuring H.225 Timeout Values 39
 - Verifying and Monitoring H.323 Inspection 39
 - Monitoring H.225 Sessions 39
 - Monitoring H.245 Sessions 40
 - Monitoring H.323 RAS Sessions 40
- Managing HTTP Inspection 41
 - HTTP Inspection Overview 41
 - Enabling and Configuring Advanced HTTP Inspection 42

Managing IPSec Pass Through Inspection	45
IPSec Pass Through Inspection Overview	45
Enabling and Configuring IPSec Pass Through Inspection	45
Managing MGCP Inspection	46
MGCP Inspection Overview	46
Configuring MGCP Call Agents and Gateways	48
Configuring and Enabling MGCP Inspection	48
Configuring MGCP Timeout Values	51
Verifying and Monitoring MGCP Inspection	51
Managing RTSP Inspection	52
RTSP Inspection Overview	52
Using RealPlayer	52
Restrictions and Limitations	53
Configuring RTSP Inspection	53
Managing SIP Inspection	55
SIP Inspection Overview	55
SIP Instant Messaging	56
Enabling and Configuring SIP Inspection	57
Configuring SIP Timeout Values	58
Verifying and Monitoring SIP Inspection	59
Managing Skinny (SCCP) Inspection	59
SCCP Inspection Overview	60
Supporting Cisco IP Phones	60
Restrictions and Limitations	60
Verifying and Monitoring SCCP Inspection	62
Managing SMTP and Extended SMTP Inspection	63
SMTP and Extended SMTP Inspection Overview	63
Enabling and Configuring SMTP and Extended SMTP Application Inspection	64
Managing SNMP Inspection	66
SNMP Inspection Overview	66
Enabling and Configuring SNMP Application Inspection	66
Managing Sun RPC Inspection	69
Sun RPC Inspection Overview	69
Enabling and Configuring Sun RPC Inspection	69
Managing Sun RPC Services	71
Verifying and Monitoring Sun RPC Inspection	72

- ARP Inspection Overview 1
- Adding a Static ARP Entry 2
- Enabling ARP Inspection 2
- Customizing the MAC Address Table 3
 - MAC Address Table Overview 3
 - Adding a Static MAC Address 3
 - Setting the MAC Address Timeout 3
 - Disabling MAC Address Learning 4
 - Viewing the MAC Address Table 4

PART 3

Configuring VPN

CHAPTER 23

Configuring IPsec and ISAKMP 1

- Tunneling Overview 1
- IPsec Overview 2
- Configuring ISAKMP 2
 - ISAKMP Overview 2
 - Configuring ISAKMP Policies 5
 - Enabling ISAKMP on the Outside Interface 6
 - Disabling ISAKMP in Aggressive Mode 6
 - Determining an ID Method for ISAKMP Peers 6
 - Enabling IPsec over NAT-T 7
 - Using NAT-T 7
 - Enabling IPsec over TCP 8
 - Waiting for Active Sessions to Terminate Prior to Reboot 8
 - Alerting Peers Before Disconnecting 9
- Configuring Certificate Group Matching 9
 - Creating a Certificate Group Matching Rule and Policy 10
 - Using the Tunnel-group-map default-group Command 11
- Configuring IPsec 11
 - Understanding IPsec Tunnels 11
 - Understanding Transform Sets 12
 - Defining Crypto Maps 12
 - Applying Crypto Maps to Interfaces 20
 - Using Interface Access Lists 20
 - Changing IPsec SA Lifetimes 22
 - Creating a Basic IPsec Configuration 23
 - Using Dynamic Crypto Maps 24
 - Providing Site-to-Site Redundancy 26

Viewing an IPsec Configuration	26
Clearing Security Associations	27
Clearing Crypto Map Configurations	27

CHAPTER 24

Setting General VPN Parameters	1
Configuring VPNs in Single, Routed Mode	1
Configuring IPsec to Bypass ACLs	1
Permitting Intra-Interface Traffic	2
NAT Considerations for Intra-Interface Traffic	3
Setting Maximum Active IPsec VPN Sessions	3
Configuring Client Update	3

CHAPTER 25

Configuring Tunnel Groups, Group Policies, and Users	1
Overview of Tunnel Groups, Group Policies, and Users	1
Tunnel Groups	2
General Tunnel Group Parameters	2
IPsec Connection Parameters	3
Configuring Tunnel Groups	4
Default Remote Access Tunnel Group Configuration	4
Configuring Remote-Access Tunnel Groups	4
Specify a Name and Type for the Remote-Access Tunnel Group	4
Configure Remote-Access Tunnel Group General Attributes	5
Configure Remote-Access Tunnel Group IPsec Attributes	6
Default LAN-to-LAN Tunnel Group Configuration	8
Configuring LAN-to-LAN Tunnel Groups	8
Specify a Name and Type for the LAN-to-LAN Tunnel Group	8
Configure LAN-to-LAN Tunnel Group General Attributes	8
Configure LAN-to-LAN IPsec Attributes	9
Group Policies	10
Default Group Policy	11
Configuring Group Policies	12
Configuring Users	31
Viewing the Username Configuration	31
Configuring Specific Users	32
Setting a User Password and Privilege Level	32
Configuring User Attributes	33

CHAPTER 26

Configuring IP Addresses for VPNs 1

- Configuring an IP Address Assignment Method 1
- Configuring Local IP Address Pools 2
- Configuring AAA Addressing 2
- Configuring DHCP Addressing 3

CHAPTER 27

Configuring Remote Access VPNs 1

- Summary of the Configuration 1
- Configuring Interfaces 2
- Configuring ISAKMP Policy and Enabling ISAKMP on the Outside Interface 3
- Configuring an Address Pool 4
- Adding a User 4
- Creating a Transform Set 4
- Defining a Tunnel Group 5
- Creating a Dynamic Crypto Map 6
- Creating a Crypto Map Entry to Use the Dynamic Crypto Map 7

CHAPTER 28

Configuring LAN-to-LAN VPNs 1

- Summary of the Configuration 1
- Configuring Interfaces 2
- Configuring ISAKMP Policy and Enabling ISAKMP on the Outside Interface 2
- Creating a Transform Set 4
- Configuring an ACL 4
- Defining a Tunnel Group 5
- Creating a Crypto Map and Applying It To an Interface 6
 - Applying Crypto Maps to Interfaces 7

CHAPTER 29

Configuring WebVPN 1

- Observing WebVPN Security Precautions 2
- Understanding Features Not Supported for WebVPN 2
- Using SSL to Access the Central Site 3
 - Using HTTPS for WebVPN Sessions 3
 - Setting WebVPN HTTP/HTTPS Proxy 3
 - Configuring SSL/TLS Encryption Protocols 4
- Authenticating with Digital Certificates 4
- Enabling Cookies on Browsers for WebVPN 4

Understanding WebVPN Global and Group Policy Settings	5
Authenticating with Digital Certificates	5
Configuring DNS Globally	5
Configuring Global WebVPN Attributes	5
Creating and Applying WebVPN Policies	7
Creating Port Forwarding, URL, and Access Lists in Global Configuration Mode	7
Assigning Lists to Group Policies and Users in Group-Policy or User Mode	7
Enabling Features for Group Policies and Users	7
Assigning Users to Group Policies	7
Using a RADIUS Server	7
Using the Security Appliance Authentication Server	8
Configuring WebVPN Group Policy and User Attributes	8
Configuring Email	8
Configuring Email Proxies	9
Email Proxy Certificate Authentication	9
Configuring MAPI	10
Configuring Web Email: MS Outlook Web Access	10
Understanding WebVPN End User Set-up	10
Defining the End User Interface	10
Viewing the WebVPN Home Page	11
Viewing the WebVPN Application Access Panel	11
Viewing the Floating Toolbar	12
Requiring Usernames and Passwords	12
Communicating Security Tips	13
Configuring Remote Systems to Use WebVPN Features	13
Recovering from hosts File Errors in Application Access	18
Understanding the hosts File	19
Stopping Application Access Improperly	19
Reconfiguring hosts Files	20
Reconfiguring hosts File Automatically Using WebVPN	20
Reconfiguring hosts File Manually	21
Capturing WebVPN Data	22
WebVPN Capture Files	22
Activating the WebVPN Capture Tool	22
Locating and Uploading the WebVPN Capture Tool Output Files	24

CHAPTER 30**Configuring Certificates** 1

Public Key Cryptography	1
About Public Key Cryptography	1

- Certificate Scalability 2
- About Key Pairs 2
- About Trustpoints 3
- About CRLs 3
- Supported CA Servers 4
- Certificate Configuration 4
 - Preparing for Certificates 4
 - Configuring Key Pairs 5
 - Generating Key Pairs 5
 - Removing Key Pairs 6
 - Configuring Trustpoints 6
 - Obtaining Certificates 8
 - Obtaining Certificates with SCEP 8
 - Obtaining Certificates Manually 10
 - Configuring CRLs for a Trustpoint 12
 - Exporting and Importing Trustpoints 14
 - Exporting a Trustpoint Configuration 14
 - Importing a Trustpoint Configuration 14
 - Configuring CA Certificate Map Rules 15

PART 4

System Administration

CHAPTER 31

Managing System Access 1

- Allowing Telnet Access 1
- Allowing SSH Access 2
 - Configuring SSH Access 2
 - Using an SSH Client 3
 - Changing the Login Password 3
- Allowing HTTPS Access for ASDM 4
- Authenticating and Authorizing System Administrators 4
 - Configuring Authentication for CLI Access 5
 - Configuring Authentication To Access Privileged EXEC Mode 5
 - Configuring Authentication for the Enable Command 6
 - Authenticating Users Using the Login Command 6
 - Configuring Command Authorization 7
 - Command Authorization Overview 7
 - Configuring Local Command Authorization 7
 - Configuring TACACS+ Command Authorization 11
 - Viewing the Current Logged-In User 14

Recovering from a Lockout	15
Configuring a Login Banner	16

CHAPTER 32**Managing Software, Licenses, and Configurations 1**

Managing Licenses	1
Obtaining an Activation Key	1
Entering a New Activation Key	2
Viewing Files in Flash Memory	2
Retrieving Files from Flash Memory	3
Downloading Files to Flash Memory from a Server	3
Ensure Network Access to the Server	4
Downloading Files	4
Configuring the Application Image and ASDM Image to Boot	5
Performing Zero Downtime Upgrades for Failover Pairs	5
Upgrading an Active/Standby Failover Configuration	6
Upgrading and Active/Active Failover Configuration	7
Downloading and Backing Up Configuration Files	7
Downloading a Text File to the Startup or Running Configuration	8
Configuring the File to Boot as the Startup Configuration	9
Copying the Startup Configuration to the Running Configuration	9
Backing Up the Configuration	9
Backing up the Single Mode or Multiple Mode System Configuration	10
Backing up a Context Configuration within the Context	10
Copying the Configuration from the Terminal Display	10
Configuring Auto Update Support	11
Configuring Communication with an Auto Update Server	11
Viewing Auto Update Status	12

CHAPTER 33**Monitoring and Troubleshooting 1**

Monitoring the Security Appliance	1
Using System Log Messages	1
Using SNMP	1
SNMP Overview	1
Enabling SNMP	3
Troubleshooting the Security Appliance	4
Testing Your Configuration	4
Enabling ICMP Debug Messages and System Messages	5
Pinging Security Appliance Interfaces	5

- Pinging Through the Security Appliance 7
- Disabling the Test Configuration 8
- Reloading the Security Appliance 9
- Performing Password Recovery 9
 - Performing Password Recovery for the ASA 5500 Series Adaptive Security Appliance 9
 - Password Recovery for the PIX 500 Series Security Appliance 11
 - Disabling Password Recovery 12
- Other Troubleshooting Tools 12
 - Viewing Debug Messages 13
 - Capturing Packets 13
 - Viewing the Crash Dump 13
- Common Problems 13

PART 5

Reference

APPENDIX A

Feature Licenses and Specifications 1

- Supported Platforms 1
- Platform Feature Licenses 1
- Security Services Module Support 6
- VPN Specifications 6
 - Cisco VPN Client Support 7
 - Site-to-Site VPN Compatibility 7
 - Cryptographic Standards 8

APPENDIX B

Sample Configurations 1

- Example 1: Multiple Mode Firewall With Outside Access 1
 - Example 1: System Configuration 2
 - Example 1: Admin Context Configuration 3
 - Example 1: Customer A Context Configuration 4
 - Example 1: Customer B Context Configuration 4
 - Example 1: Customer C Context Configuration 5
- Example 2: Single Mode Firewall Using Same Security Level 5
- Example 3: Shared Resources for Multiple Contexts 7
 - Example 3: System Configuration 8
 - Example 3: Admin Context Configuration 9
 - Example 3: Department 1 Context Configuration 10
 - Example 3: Department 2 Context Configuration 11
- Example 4: Multiple Mode, Transparent Firewall with Outside Access 12

Example 4: System Configuration	13
Example 4: Admin Context Configuration	14
Example 4: Customer A Context Configuration	14
Example 4: Customer B Context Configuration	14
Example 4: Customer C Context Configuration	15
Example 5: WebVPN Configuration	15

APPENDIX C**Using the Command-Line Interface 1**

Firewall Mode and Security Context Mode	1
Command Modes and Prompts	2
Syntax Formatting	3
Abbreviating Commands	3
Command-Line Editing	3
Command Completion	3
Command Help	4
Filtering show Command Output	4
Command Output Paging	5
Adding Comments	5
Text Configuration Files	6
How Commands Correspond with Lines in the Text File	6
Command-Specific Configuration Mode Commands	6
Automatic Text Entries	6
Line Order	7
Commands Not Included in the Text Configuration	7
Passwords	7
Multiple Security Context Files	7

APPENDIX D**Addresses, Protocols, and Ports 1**

IPv4 Addresses and Subnet Masks	1
Classes	2
Private Networks	2
Subnet Masks	2
Determining the Subnet Mask	3
Determining the Address to Use with the Subnet Mask	3
IPv6 Addresses	5
IPv6 Address Format	5
IPv6 Address Types	6
Unicast Addresses	6

- Multicast Address 8
- Anycast Address 9
- Required Addresses 10
- IPv6 Address Prefixes 10
- Protocols and Applications 11
- TCP and UDP Ports 12
- Local Ports and Protocols 14
- ICMP Types 15

INDEX



About This Guide

This preface introduces the *Cisco Security Appliance Command Line Configuration Guide*, and includes the following sections:

- [Document Objectives, page 25](#)
- [Obtaining Documentation and Submitting a Service Request, page 29](#)

Document Objectives

The purpose of this guide is to help you configure the security appliance using the command-line interface. This guide does not cover every feature, but describes only the most common configuration scenarios.

You can also configure and monitor the security appliance by using ASDM, a web-based GUI application. ASDM includes configuration wizards to guide you through some common configuration scenarios, and online Help for less common scenarios. For more information, see: <http://www.cisco.com/univercd/cc/td/doc/product/netsec/secmgmt/asdm/index.htm>

This guide applies to the Cisco PIX 500 series security appliances (PIX 515E, PIX 525, and PIX 535) and the Cisco ASA 5500 series security appliances (ASA 5510, ASA 5520, and ASA 5540). Throughout this guide, the term “security appliance” applies generically to all supported models, unless specified otherwise. The PIX 501, PIX 506E, and PIX 520 security appliances are not supported in software Version 7.0.

Audience

This guide is for network managers who perform any of the following tasks:

- Manage network security
- Install and configure firewalls/security appliances
- Configure VPNs
- Configure intrusion detection software

Related Documentation

For more information, refer to the following documentation:

- *Cisco PIX Security Appliance Release Notes*
- *Cisco ASDM Release Notes*
- *Cisco PIX 515E Quick Start Guide*
- *Guide for Cisco PIX 6.2 and 6.3 Users Upgrading to Cisco PIX Software Version 7.0*
- *Cisco Security Appliance Command Reference*
- *Cisco ASA 5500 Series Quick Start Guide*
- *Cisco ASA 5500 Series Release Notes*
- *Cisco Security Appliance Logging Configuration and System Log Messages*

Document Organization

This guide includes the chapters and appendixes described in [Table 1](#).

Table 1 Document Organization

Chapter/Appendix	Definition
Part 1: Getting Started and General Information	
Chapter 1, “Introduction to the Security Appliance”	Provides a high-level overview of the security appliance.
Chapter 2, “Getting Started”	Describes how to access the command-line interface, configure the firewall mode, and work with the configuration.
Chapter 3, “Enabling Multiple Context Mode”	Describes how to use security contexts and enable multiple context mode.
Chapter 4, “Configuring Ethernet Settings and Subinterfaces”	Describes how to configure Ethernet settings for physical interfaces and add subinterfaces.
Chapter 5, “Adding and Managing Security Contexts”	Describes how to configure multiple security contexts on the security appliance.
Chapter 6, “Configuring Interface Parameters”	Describes how to configure each interface and subinterface for a name, security, level, and IP address.
Chapter 7, “Configuring Basic Settings”	Describes how to configure basic settings that are typically required for a functioning configuration.
Chapter 8, “Configuring IP Routing and DHCP Services”	Describes how to configure IP routing and DHCP.
Chapter 9, “Configuring IPv6”	Describes how to enable and configure IPv6.
Chapter 10, “Configuring AAA Servers and the Local Database”	Describes how to configure AAA servers and the local database.
Chapter 11, “Configuring Failover”	Describes the failover feature, which lets you configure two security appliances so that one will take over operation if the other one fails.

Table 1 Document Organization (continued)

Chapter/Appendix	Definition
Part 2: Configuring the Firewall	
Chapter 12, “Firewall Mode Overview”	Describes in detail the two operation modes of the security appliance, routed and transparent mode, and how data is handled differently with each mode.
Chapter 13, “Identifying Traffic with Access Lists”	Describes how to identify traffic with access lists.
Chapter 14, “Applying NAT”	Describes how address translation is performed.
Chapter 15, “Permitting or Denying Network Access”	Describes how to control network access through the security appliance using access lists.
Chapter 16, “Applying AAA for Network Access”	Describes how to enable AAA for network access.
Chapter 17, “Applying Filtering Services”	Describes ways to filter web traffic to reduce security risks or prevent inappropriate use.
Chapter 18, “Using Modular Policy Framework”	Describes how to use the Modular Policy Framework to create security policies for TCP, general connection settings, inspection, and QoS.
Chapter 19, “Intercepting and Responding to Network Attacks”	Describes how to configure protection features to intercept and respond to network attacks.
Chapter 20, “Applying QoS Policies”	Describes how to configure the network to provide better service to selected network traffic over various technologies, including Frame Relay, Asynchronous Transfer Mode (ATM), Ethernet and 802.1 networks, SONET, and IP routed networks.
Chapter 21, “Applying Application Layer Protocol Inspection”	Describes how to use and configure application inspection.
Chapter 22, “Configuring ARP Inspection and Bridging Parameters”	Describes how to enable ARP inspection and how to customize bridging operations.
Part 3: Configuring VPN	
Chapter 23, “Configuring IPsec and ISAKMP”	Describes how to configure ISAKMP and IPsec tunneling to build and manage VPN “tunnels,” or secure connections between remote users and a private corporate network.
Chapter 24, “Setting General VPN Parameters”	Describes miscellaneous VPN configuration procedures.
Chapter 25, “Configuring Tunnel Groups, Group Policies, and Users”	Describes how to configure VPN tunnel groups, group policies, and users.
Chapter 26, “Configuring IP Addresses for VPNs”	Describes how to configure IP addresses in your private network addressing scheme, which let the client function as a tunnel endpoint.
Chapter 27, “Configuring Remote Access VPNs”	Describes how to configure a remote access VPN connection.
Chapter 28, “Configuring LAN-to-LAN VPNs”	Describes how to build a LAN-to-LAN VPN connection.
Chapter 29, “Configuring WebVPN”	Describes how to establish a secure, remote-access VPN tunnel to a security appliance using a web browser.

Table 1 Document Organization (continued)

Chapter/Appendix	Definition
Chapter 30, “Configuring Certificates”	Describes how to configure a digital certificates, which contains information that identifies a user or device. Such information can include a name, serial number, company, department, or IP address. A digital certificate also contains a copy of the public key for the user or device.
Part 4: System Administration	
Chapter 31, “Managing System Access”	Describes how to access the security appliance for system management through Telnet, SSH, and HTTPS.
Chapter 32, “Managing Software, Licenses, and Configurations”	Describes how to enter license keys and download software and configurations files.
Chapter 33, “Monitoring and Troubleshooting”	Describes how to monitor and troubleshoot the security appliance.
Appendix A, “Feature Licenses and Specifications”	Describes the feature licenses and specifications.
Appendix B, “Sample Configurations”	Describes a number of common ways to implement the security appliance.
Appendix C, “Using the Command-Line Interface”	Describes how to use the CLI to configure the the security appliance.
Appendix D, “Addresses, Protocols, and Ports”	Provides a quick reference for IP addresses, protocols, and applications.

Document Conventions

Command descriptions use these conventions:

- Braces ({ }) indicate a required choice.
- Square brackets ([]) indicate optional elements.
- Vertical bars (|) separate alternative, mutually exclusive elements.
- **Boldface** indicates commands and keywords that are entered literally as shown.
- *Italics* indicate arguments for which you supply values.

Examples use these conventions:

- Examples depict screen displays and the command line in *screen* font.
- Information you need to enter in examples is shown in **boldface screen** font.
- Variables for which you must supply a value are shown in *italic screen* font.



Note

Means *reader take note*. Notes contain helpful suggestions or references to material not covered in the manual.

Obtaining Documentation and Submitting a Service Request

For information on obtaining documentation, submitting a service request, and gathering additional information, see the monthly *What's New in Cisco Product Documentation*, which also lists all new and revised Cisco technical documentation, at:

<http://www.cisco.com/en/US/docs/general/whatsnew/whatsnew.html>

Subscribe to the *What's New in Cisco Product Documentation* as a Really Simple Syndication (RSS) feed and set content to be delivered directly to your desktop using a reader application. The RSS feeds are a free service and Cisco currently supports RSS Version 2.0.



PART 1

Getting Started and General Information





Introduction to the Security Appliance

The security appliance combines advanced stateful firewall and VPN concentrator functionality in one device, and for some models, an integrated intrusion prevention module called the AIP SSM. The security appliance includes many advanced features, such as multiple security contexts (similar to virtualized firewalls), transparent (Layer 2) firewall or routed (Layer 3) firewall operation, advanced inspection engines, IPSec and WebVPN support, and many more features. See [Appendix A, “Feature Licenses and Specifications,”](#) for a list of supported platforms and features. For a list of new features, see the *Cisco ASA 5500 Series Release Notes* or the *Cisco PIX Security Appliance Release Notes*.



Note

The Cisco PIX 501 and PIX 506E security appliances are not supported in software Version 7.0.

This chapter includes the following sections:

- [Firewall Functional Overview, page 1-1](#)
- [VPN Functional Overview, page 1-5](#)
- [Intrusion Prevention Services Functional Overview, page 1-5](#)
- [Security Context Overview, page 1-5](#)

Firewall Functional Overview

Firewalls protect inside networks from unauthorized access by users on an outside network. A firewall can also protect inside networks from each other, for example, by keeping a human resources network separate from a user network. If you have network resources that need to be available to an outside user, such as a web or FTP server, you can place these resources on a separate network behind the firewall, called a *demilitarized zone* (DMZ). The firewall allows limited access to the DMZ, but because the DMZ only includes the public servers, an attack there only affects the servers and does not affect the other inside networks. You can also control when inside users access outside networks (for example, access to the Internet), by allowing only certain addresses out, by requiring authentication or authorization, or by coordinating with an external URL filtering server.

When discussing networks connected to a firewall, the *outside* network is in front of the firewall, the *inside* network is protected and behind the firewall, and a *DMZ*, while behind the firewall, allows limited access to outside users. Because the security appliance lets you configure many interfaces with varied security policies, including many inside interfaces, many DMZs, and even many outside interfaces if desired, these terms are used in a general sense only.

This section includes the following topics:

- [Security Policy Overview, page 1-2](#)
- [Firewall Mode Overview, page 1-3](#)
- [Stateful Inspection Overview, page 1-4](#)

Security Policy Overview

A security policy determines which traffic is allowed to pass through the firewall to access another network. By default, the security appliance allows traffic to flow freely from an inside network (higher security level) to an outside network (lower security level). You can apply actions to traffic to customize the security policy. This section includes the following topics:

- [Permitting or Denying Traffic with Access Lists, page 1-2](#)
- [Applying NAT, page 1-2](#)
- [Using AAA for Through Traffic, page 1-2](#)
- [Applying HTTP, HTTPS, or FTP Filtering, page 1-3](#)
- [Applying Application Inspection, page 1-3](#)
- [Sending Traffic to the Advanced Inspection and Prevention Security Services Module, page 1-3](#)
- [Applying QoS Policies, page 1-3](#)
- [Applying Connection Limits and TCP Normalization, page 1-3](#)

Permitting or Denying Traffic with Access Lists

You can apply an access list to limit traffic from inside to outside, or allow traffic from outside to inside. For transparent firewall mode, you can also apply an EtherType access list to allow non-IP traffic.

Applying NAT

Some of the benefits of NAT include the following:

- You can use private addresses on your inside networks. Private addresses are not routable on the Internet.
- NAT hides the local addresses from other networks, so attackers cannot learn the real address of a host.
- NAT can resolve IP routing problems by supporting overlapping IP addresses.

Using AAA for Through Traffic

You can require authentication and/or authorization for certain types of traffic, for example, for HTTP. The security appliance also sends accounting information to a RADIUS or TACACS+ server.

Applying HTTP, HTTPS, or FTP Filtering

Although you can use access lists to prevent outbound access to specific websites or FTP servers, configuring and managing web usage this way is not practical because of the size and dynamic nature of the Internet. We recommend that you use the security appliance in conjunction with a separate server running one of the following Internet filtering products:

- Websense Enterprise
- Sentian by N2H2

Applying Application Inspection

Inspection engines are required for services that embed IP addressing information in the user data packet or that open secondary channels on dynamically assigned ports. These protocols require the security appliance to do a deep packet inspection.

Sending Traffic to the Advanced Inspection and Prevention Security Services Module

If your model supports the AIP SSM for intrusion prevention, then you can send traffic to the AIP SSM for inspection.

Applying QoS Policies

Some network traffic, such as voice and streaming video, cannot tolerate long latency times. QoS is a network feature that lets you give priority to these types of traffic. QoS refers to the capability of a network to provide better service to selected network traffic over various technologies for the best overall services with limited bandwidth of the underlying technologies.

Applying Connection Limits and TCP Normalization

You can limit TCP and UDP connections and embryonic connections. Limiting the number of connections and embryonic connections protects you from a DoS attack. The security appliance uses the embryonic limit to trigger TCP Intercept, which protects inside systems from a DoS attack perpetrated by flooding an interface with TCP SYN packets. An embryonic connection is a connection request that has not finished the necessary handshake between source and destination.

TCP normalization is a feature consisting of advanced TCP connection settings designed to drop packets that do not appear normal.

Firewall Mode Overview

The security appliance runs in two different firewall modes:

- Routed
- Transparent

In routed mode, the security appliance is considered to be a router hop in the network.

In transparent mode, the security appliance acts like a “bump in the wire,” or a “stealth firewall,” and is not considered a router hop. The security appliance connects to the same network on its inside and outside interfaces.

You might use a transparent firewall to simplify your network configuration. Transparent mode is also useful if you want the firewall to be invisible to attackers. You can also use a transparent firewall for traffic that would otherwise be blocked in routed mode. For example, a transparent firewall can allow multicast streams using an EtherType access list.

Stateful Inspection Overview

All traffic that goes through the security appliance is inspected using the Adaptive Security Algorithm and either allowed through or dropped. A simple packet filter can check for the correct source address, destination address, and ports, but it does not check that the packet sequence or flags are correct. A filter also checks every packet against the filter, which can be a slow process.

A stateful firewall like the security appliance, however, takes into consideration the state of a packet:

- Is this a new connection?

If it is a new connection, the security appliance has to check the packet against access lists and perform other tasks to determine if the packet is allowed or denied. To perform this check, the first packet of the session goes through the “session management path,” and depending on the type of traffic, it might also pass through the “control plane path.”

The session management path is responsible for the following tasks:

- Performing the access list checks
- Performing route lookups
- Allocating NAT translations (xlates)
- Establishing sessions in the “fast path”



Note The session management path and the fast path make up the “accelerated security path.”

Some packets that require Layer 7 inspection (the packet payload must be inspected or altered) are passed on to the control plane path. Layer 7 inspection engines are required for protocols that have two or more channels: a data channel, which uses well-known port numbers, and a control channel, which uses different port numbers for each session. These protocols include FTP, H.323, and SNMP.

- Is this an established connection?

If the connection is already established, the security appliance does not need to re-check packets; most matching packets can go through the fast path in both directions. The fast path is responsible for the following tasks:

- IP checksum verification
- Session lookup
- TCP sequence number check
- NAT translations based on existing sessions
- Layer 3 and Layer 4 header adjustments

For UDP or other connectionless protocols, the security appliance creates connection state information so that it can also use the fast path.

Data packets for protocols that require Layer 7 inspection can also go through the fast path.

Some established session packets must continue to go through the session management path or the control plane path. Packets that go through the session management path include HTTP packets that require inspection or content filtering. Packets that go through the control plane path include the control packets for protocols that require Layer 7 inspection.

VPN Functional Overview

A VPN is a secure connection across a TCP/IP network (such as the Internet) that appears as a private connection. This secure connection is called a tunnel. The security appliance uses tunneling protocols to negotiate security parameters, create and manage tunnels, encapsulate packets, transmit or receive them through the tunnel, and unencapsulate them. The security appliance functions as a bidirectional tunnel endpoint: it can receive plain packets, encapsulate them, and send them to the other end of the tunnel where they are unencapsulated and sent to their final destination. It can also receive encapsulated packets, unencapsulate them, and send them to their final destination. The security appliance invokes various standard protocols to accomplish these functions.

The security appliance performs the following functions:

- Establishes tunnels
- Negotiates tunnel parameters
- Authenticates users
- Assigns user addresses
- Encrypts and decrypts data
- Manages security keys
- Manages data transfer across the tunnel
- Manages data transfer inbound and outbound as a tunnel endpoint or router

The security appliance invokes various standard protocols to accomplish these functions.

Intrusion Prevention Services Functional Overview

The Cisco ASA 5500 series adaptive security appliance supports the AIP SSM, an intrusion prevention services module that monitors and performs real-time analysis of network traffic by looking for anomalies and misuse based on an extensive, embedded signature library. When the system detects unauthorized activity, it can terminate the specific connection, permanently block the attacking host, log the incident, and send an alert to the device manager. Other legitimate connections continue to operate independently without interruption. For more information, see *Configuring the Cisco Intrusion Prevention System Sensor Using the Command Line Interface*.

Security Context Overview

You can partition a single security appliance into multiple virtual devices, known as security contexts. Each context is an independent device, with its own security policy, interfaces, and administrators. Multiple contexts are similar to having multiple standalone devices. Many features are supported in multiple context mode, including routing tables, firewall features, IPS, and management. Some features are not supported, including VPN and dynamic routing protocols.

In multiple context mode, the security appliance includes a configuration for each context that identifies the security policy, interfaces, and almost all the options you can configure on a standalone device. The system administrator adds and manages contexts by configuring them in the system configuration, which, like a single mode configuration, is the startup configuration. The system configuration identifies basic settings for the security appliance. The system configuration does not include any network interfaces or network settings for itself; rather, when the system needs to access network resources (such as downloading the contexts from the server), it uses one of the contexts that is designated as the admin context.

The admin context is just like any other context, except that when a user logs into the admin context, then that user has system administrator rights and can access the system and all other contexts.

**Note**

You can run all your contexts in routed mode or transparent mode; you cannot run some contexts in one mode and others in another.

Multiple context mode supports static routing only.



Getting Started

This chapter describes how to access the command-line interface, configure the firewall mode, and work with the configuration. This chapter includes the following sections:

- [Accessing the Command-Line Interface, page 2-1](#)
- [Setting Transparent or Routed Firewall Mode, page 2-2](#)
- [Working with the Configuration, page 2-3](#)

Accessing the Command-Line Interface

For initial configuration, access the command-line interface directly from the console port. Later, you can configure remote access using Telnet or SSH according to [Chapter 31, “Managing System Access.”](#) If your system is already in multiple context mode, then accessing the console port places you in the system execution space. See [Chapter 3, “Enabling Multiple Context Mode,”](#) for more information about multiple context mode.



Note

If you want to use ASDM to configure the security appliance instead of the command-line interface, you can connect to the default management address of 192.168.1.1 (if your security appliance includes a factory default configuration). On the ASA 5500 series adaptive security appliance, the interface to which you connect with ASDM is Management 0/0. For the PIX 500 series security appliance, the interface to which you connect with ASDM is Ethernet 1. If you do not have a factory default configuration, follow the steps in this section to access the command-line interface. You can then configure the minimum parameters to access ASDM by entering the **setup** command.

To access the command-line interface, perform the following steps:

- Step 1** Connect a PC to the console port using the provided console cable, and connect to the console using a terminal emulator set for 9600 baud, 8 data bits, no parity, 1 stop bit, no flow control.
- See the hardware guide that came with your security appliance for more information about the console cable.
- Step 2** Press the **Enter** key to see the following prompt:
- ```
hostname>
```
- This prompt indicates that you are in user EXEC mode.

**Step 3** To access privileged EXEC mode, enter the following command:

```
hostname> enable
```

The following prompt appears:

```
Password:
```

**Step 4** Enter the enable password at the prompt.

By default, the password is blank, and you can press the **Enter** key to continue. See the [“Changing the Enable Password”](#) section on page 7-1 to change the enable password.

The prompt changes to:

```
hostname#
```

To exit privileged mode, enter the **disable**, **exit**, or **quit** command.

**Step 5** To access global configuration mode, enter the following command:

```
hostname# configure terminal
```

The prompt changes to the following:

```
hostname(config)#
```

To exit global configuration mode, enter the **exit**, **quit**, or **end** command.

---

## Setting Transparent or Routed Firewall Mode

You can set the security appliance to run in routed firewall mode (the default) or transparent firewall mode.

For multiple context mode, you can use only one firewall mode for all contexts. You must set the mode in the system execution space.

When you change modes, the security appliance clears the configuration because many commands are not supported for both modes. If you already have a populated configuration, be sure to back up your configuration before changing the mode; you can use this backup for reference when creating your new configuration.

If you download a text configuration to the security appliance that changes the mode with the **firewall transparent** command, be sure to put the command at the top of the configuration; the security appliance changes the mode as soon as it reads the command and then continues reading the configuration you downloaded. If the command is later in the configuration, the security appliance clears all the preceding lines in the configuration.

- To set the mode to transparent, enter the following command in the system execution space:

```
hostname(config)# firewall transparent
```

This command also appears in each context configuration for informational purposes only; you cannot enter this command in a context.

- To set the mode to routed, enter the following command in the system execution space:

```
hostname(config)# no firewall transparent
```

# Working with the Configuration

This section describes how to work with the configuration. The security appliance loads the configuration from a text file, called the startup configuration. This file resides by default as a hidden file in internal Flash memory. You can, however, specify a different path for the startup configuration. (For more information, see [Chapter 32, “Managing Software, Licenses, and Configurations.”](#))

When you enter a command, the change is made only to the running configuration in memory. You must manually save the running configuration to the startup configuration for your changes to remain after a reboot.

The information in this section applies to both single and multiple security contexts, except where noted. Additional information about contexts is in [Chapter 3, “Enabling Multiple Context Mode.”](#)

This section includes the following topics:

- [Saving Configuration Changes, page 2-3](#)
- [Viewing the Configuration, page 2-3](#)
- [Clearing and Removing Configuration Settings, page 2-4](#)
- [Creating Text Configuration Files Offline, page 2-4](#)

## Saving Configuration Changes

To save your running configuration to the startup configuration, enter the following command:

```
hostname# copy running-config startup-config
```

For multiple context mode, context startup configurations can reside on external servers. In this case, the security appliance saves the configuration back to the server you identified in the context URL, except for an HTTP or HTTPS URL, which do not let you save the configuration to the server.

**Note**

---

The **copy running-config startup-config** command is equivalent to the **write memory** command.

---

## Viewing the Configuration

The following commands let you view the running and startup configurations.

- To view the running configuration, enter the following command:

```
hostname# show running-config
```

- To view the running configuration of a specific command, enter the following command:

```
hostname# show running-config command
```

- To view the startup configuration, enter the following command:

```
hostname# show startup-config
```

## Clearing and Removing Configuration Settings

To erase settings, enter one of the following commands.

- To clear all the configuration for a specified command, enter the following command:

```
hostname(config)# clear configure configurationcommand [level2configurationcommand]
```

This command clears all the current configuration for the specified configuration command. If you only want to clear the configuration for a specific version of the command, you can enter a value for *level2configurationcommand*.

For example, to clear the configuration for all **aaa** commands, enter the following command:

```
hostname(config)# clear configure aaa
```

To clear the configuration for only **aaa authentication** commands, enter the following command:

```
hostname(config)# clear configure aaa authentication
```

- To disable the specific parameters or options of a command, enter the following command:

```
hostname(config)# no configurationcommand [level2configurationcommand] qualifier
```

In this case, you use the **no** command to remove the specific configuration identified by *qualifier*.

For example, to remove a specific **nat** command, enter enough of the command to identify it uniquely as follows:

```
hostname(config)# no nat (inside) 1
```

- To erase the startup configuration, enter the following command:

```
hostname(config)# write erase
```

- To erase the running configuration, enter the following command:

```
hostname(config)# clear configure all
```



---

**Note** In multiple context mode, if you enter **clear configure all** from the system configuration, you also remove all contexts and stop them from running.

---

## Creating Text Configuration Files Offline

This guide describes how to use the CLI to configure the security appliance; when you save commands, the changes are written to a text file. Instead of using the CLI, however, you can edit a text file directly on your PC and paste a configuration at the configuration mode command-line prompt in its entirety, or line by line. Alternatively, you can download a text file to the security appliance internal Flash memory. See [Chapter 32, “Managing Software, Licenses, and Configurations,”](#) for information on downloading the configuration file to the security appliance.

In most cases, commands described in this guide are preceded by a CLI prompt. The prompt in the following example is “hostname(config)#”:

```
hostname(config)# context a
```

In the text configuration file you are not prompted to enter commands, so the prompt is omitted as follows:

```
context a
```

For additional information about formatting the file, see [Appendix C, “Using the Command-Line Interface.”](#)







## Enabling Multiple Context Mode

This chapter describes how to use security contexts and enable multiple context mode. This chapter includes the following sections:

- [Security Context Overview, page 3-1](#)
- [Enabling or Disabling Multiple Context Mode, page 3-10](#)

### Security Context Overview

You can partition a single security appliance into multiple virtual devices, known as security contexts. Each context is an independent device, with its own security policy, interfaces, and administrators. Multiple contexts are similar to having multiple standalone devices. Many features are supported in multiple context mode, including routing tables, firewall features, IPS, and management. Some features are not supported, including VPN and dynamic routing protocols.

In multiple context mode, the security appliance includes a configuration for each context that identifies the security policy, interfaces, and almost all the options you can configure on a standalone device. The system administrator adds and manages contexts by configuring them in the system configuration, which, like a single mode configuration, is the startup configuration. The system configuration identifies basic settings for the security appliance. The system configuration does not include any network interfaces or network settings for itself; rather, when the system needs to access network resources (such as downloading the contexts from the server), it uses one of the contexts that is designated as the admin context.

The admin context is just like any other context, except that when a user logs in to the admin context, then that user has system administrator rights and can access the system and all other contexts.

This section provides an overview of security contexts, and includes the following topics:

- [Common Uses for Security Contexts, page 3-2](#)
- [Unsupported Features, page 3-2](#)
- [Context Configuration Files, page 3-2](#)
- [How the Security Appliance Classifies Packets, page 3-3](#)
- [Sharing Interfaces Between Contexts, page 3-6](#)
- [Logging into the Security Appliance in Multiple Context Mode, page 3-10](#)

## Common Uses for Security Contexts

You might want to use multiple security contexts in the following situations:

- You are a service provider and want to sell security services to many customers. By enabling multiple security contexts on the security appliance, you can implement a cost-effective, space-saving solution that keeps all customer traffic separate and secure, and also eases configuration.
- You are a large enterprise or a college campus and want to keep departments completely separate.
- You are an enterprise that wants to provide distinct security policies to different departments.
- You have any network that requires more than one security appliance.

## Unsupported Features

Multiple context mode does not support the following features:

- Dynamic routing protocols  
Security contexts support only static routes. You cannot enable OSPF or RIP in multiple context mode.
- VPN
- Multicast

## Context Configuration Files

Each context has its own configuration file that identifies the security policy, interfaces, and, for supported features, all the options you can configure on a standalone device. You can store context configurations on the internal Flash memory or the external Flash memory card, or you can download them from a TFTP, FTP, or HTTP(S) server.

In addition to individual security contexts, the security appliance also includes a system configuration that identifies basic settings for the security appliance, including a list of contexts. Like the single mode configuration, this configuration resides as the startup configuration.

The system configuration does not include any network interfaces or network settings for itself; rather, when the system needs to access network resources (such as downloading the contexts from a server), it uses one of the contexts that is designated as the admin context. The system configuration does include a specialized failover interface for failover traffic only. If your system is already in multiple context mode, or if you convert from single mode, the admin context is created automatically as a file on the internal Flash memory called `admin.cfg`. This context is named “admin.” If you do not want to use `admin.cfg` as the admin context, you can change the admin context.

## How the Security Appliance Classifies Packets

Each packet that enters the security appliance must be classified, so that the security appliance can determine to which context to send a packet. The classifier uses the following rules to assign the packet to a context:

1. If only one context is associated with the ingress interface, the security appliance classifies the packet into that context.

In transparent firewall mode, unique interfaces for contexts are required, so this method is used to classify packets at all times.

2. If multiple contexts are associated with the ingress interface, then the security appliance classifies the packet into a context by matching the destination address to one of the following context configurations:

- a. Interface IP address (the **ip address** command)

The classifier looks at the interface IP address for traffic destined to an interface, such as management traffic.

- b. Global address in a static NAT statement (the **static** command)

The classifier only looks at **static** commands where the global interface matches the ingress interface of the packet.

- c. Global NAT pool address (the **global** command)

The classifier looks at IP addresses identified by a global pool for the ingress interface.



---

**Note** The classifier does not use a NAT exemption configuration for classification purposes because NAT exemption does not identify a global interface.

---

For example, if each context has unique interfaces, then the classifier associates the packet with the context based on the ingress interface. If you share an interface across contexts, however, then the classifier uses the destination address.

Because the destination address classification requires NAT (for through traffic), be sure to use unique interfaces for each context if you do not use NAT. Alternatively, you can add a **global** command to the ingress interface that specifies the real addresses in a context; a matching **nat** command is not required for classification purposes.

Figure 3-1 shows multiple contexts sharing an outside interface, while the inside interfaces are unique, allowing overlapping IP addresses. The classifier assigns the packet to Context B because Context B includes the address translation that matches the destination address.

**Figure 3-1 Packet Classification with a Shared Interface**

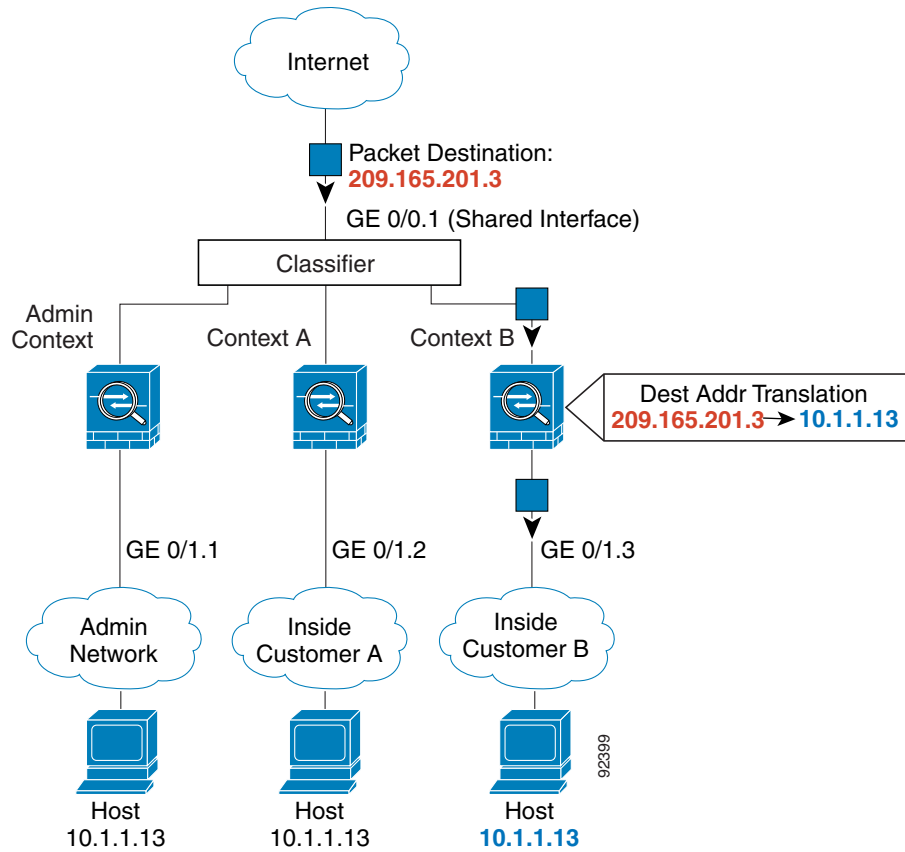

Note that all new incoming traffic must be classified, even from inside networks. [Figure 3-2](#) shows a host on the Context B inside network accessing the Internet. The classifier assigns the packet to Context B because the ingress interface is Gigabit Ethernet 0/1.3, which is assigned to Context B.

**Figure 3-2** Incoming Traffic from Inside Networks

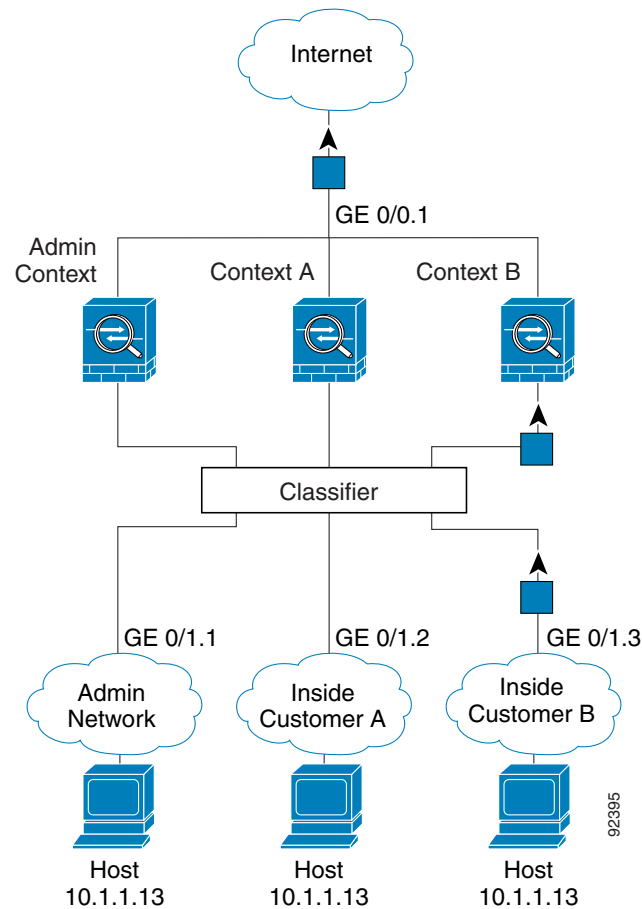

For transparent firewalls, you must use unique interfaces. For the classifier, the lack of NAT support in transparent mode leaves unique interfaces as the only means of classification. [Figure 3-3](#) shows a host on the Context B inside network accessing the Internet. The classifier assigns the packet to Context B because the ingress interface is Gigabit Ethernet 1/0.3, which is assigned to Context B.

**Figure 3-3** Transparent Firewall Contexts

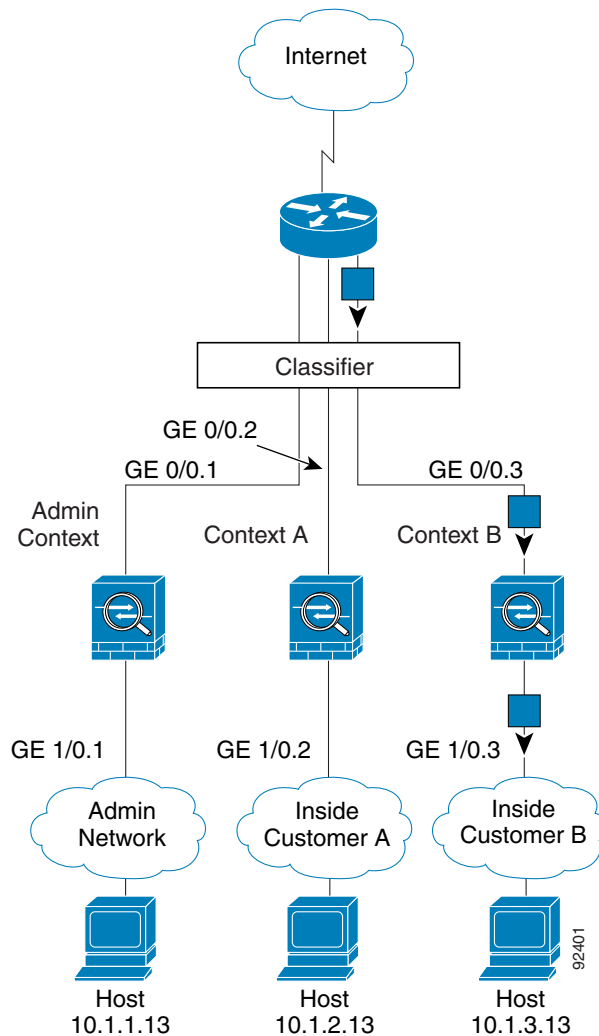

## Sharing Interfaces Between Contexts

### Routed Mode Only

The security appliance lets you share an interface between contexts. For example, you might share the outside interface to conserve interfaces. You can also share inside interfaces to share resources between contexts.

This section includes the following topics:

- [Shared Interface Guidelines, page 3-7](#)
- [Cascading Security Contexts, page 3-9](#)

## Shared Interface Guidelines

If you want to allow traffic from a shared interface through the security appliance, then you must translate the *destination* addresses of the traffic; the classifier relies on the address translation configuration to classify the packet within a context. If you do not want to perform NAT, you can still ensure classification into a context by specifying a **global** command for the shared interface: the **global** command specifies the real destination addresses, and a matching **nat** command is not required. (If you share an interface, and you allow only management traffic to and from the interface, then the classifier uses the interface IP address configuration to classify the packets. NAT configuration does not enter into the process.)

The type of NAT configured for the destination address determines whether the traffic can originate on the shared interface or if it can only respond to an existing connection. When you use dynamic NAT for the destination addresses, you cannot initiate a connection to those addresses. Therefore, traffic from the shared interface must be in response to an existing connection. Static NAT, however, lets you initiate connections, so if you use static NAT for the destination addresses, you can initiate connections on the shared interface.

When you have an outside shared interface (connected to the Internet, for example), the destination addresses on the inside are limited, and are known by the system administrator, so configuring NAT for those addresses is easy, even if you want to configure static NAT.

Configuring an inside shared interface poses a problem, however, if you want to allow communication between the shared interface and the Internet, where the destination addresses are unlimited. For example, if you want to allow inside hosts on the shared interface to initiate traffic to the Internet, then you need to configure static NAT statements for each Internet address. This requirement necessarily limits the kind of Internet access you can provide for users on an inside shared interface. (If you intend to statically translate addresses for Internet servers, then you also need to consider DNS entry addresses and how NAT affects them. For example, if a server sends a packet to `www.example.com`, then the DNS server needs to return the translated address. Your NAT configuration determines DNS entry management.)

Figure 3-4 shows two servers on an inside shared interface. One server sends a packet to the translated address of a web server, and the security appliance classifies the packet to go through Context C because it includes a static translation for the address. The other server sends the packet to the real untranslated address, and the packet is dropped because the security appliance cannot classify it.

Figure 3-4 Originating Traffic on a Shared Interface

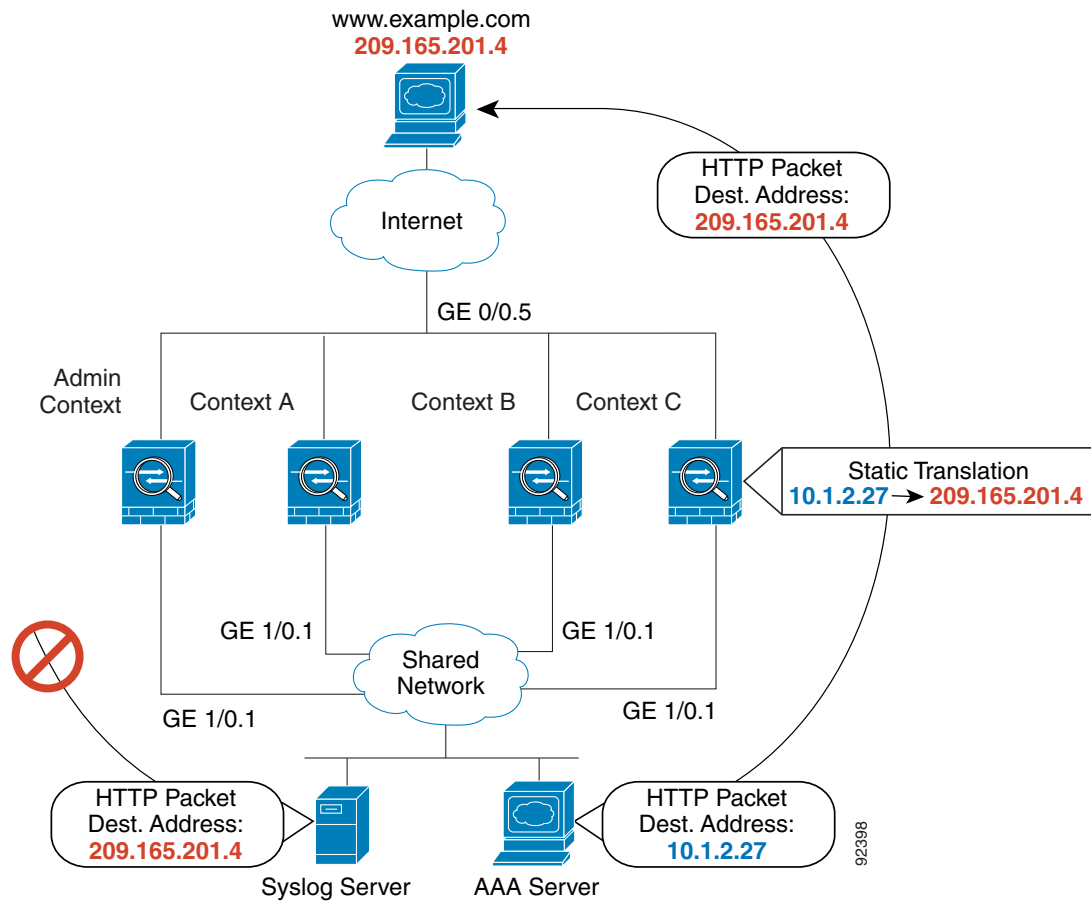



## Cascading Security Contexts

Because of the limitation for originating traffic on a shared interface, a scenario where you place one context behind another requires that you configure static statements in the top context for every single outside address that bottom context users want to access.

Figure 3-5 shows a user in the bottom context (Context A) trying to access `www.example.com`. Because the Gateway Context does not have a static translation for `www.example.com`, the user cannot access the web server; the classifier does not know which context on the shared interface to assign the packet.

**Figure 3-5 Cascading Contexts**

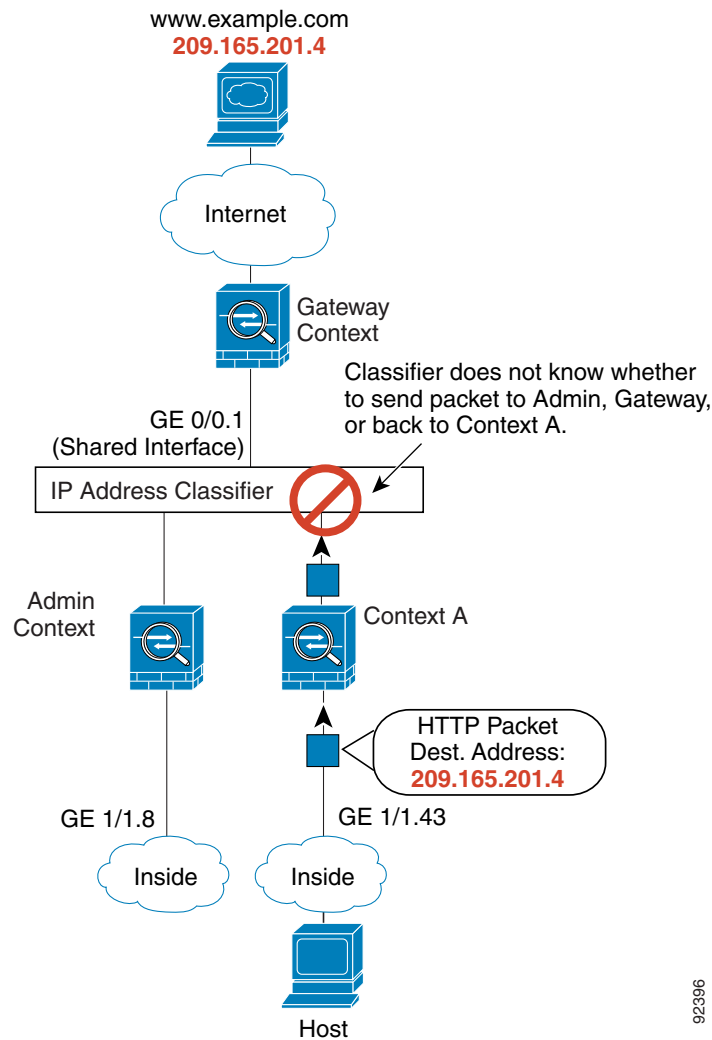

92396

## Logging into the Security Appliance in Multiple Context Mode

When you access the security appliance console, you access the system execution space. If you later configure Telnet or SSH access to a context, you can log in to a specific context. If you log in to a specific context, you can only access the configuration for that context. However, if you log in to the admin context or the system execution space, you can access all contexts.

When you change to a context from admin, you continue to use the username and command authorization settings set in the admin context.

The system execution space does not support any AAA commands, but you can configure its own enable password, as well as usernames in the local database to provide individual logins.

## Enabling or Disabling Multiple Context Mode

Your security appliance might already be configured for multiple security contexts depending on how you ordered it from Cisco. If you are upgrading, however, you might need to convert from single mode to multiple mode by following the procedures in this section. ASDM does not support changing modes, so you need to change modes using the CLI.

This section includes the following topics:

- [Backing Up the Single Mode Configuration, page 3-10](#)
- [Enabling Multiple Context Mode, page 3-10](#)
- [Restoring Single Context Mode, page 3-11](#)

## Backing Up the Single Mode Configuration

When you convert from single mode to multiple mode, the security appliance converts the running configuration into two files. The original startup configuration is not saved, so if it differs from the running configuration, you should back it up before proceeding.

## Enabling Multiple Context Mode

The context mode (single or multiple) is not stored in the configuration file, even though it does endure reboots. If you need to copy your configuration to another device, set the mode on the new device to match using the **mode** command.

When you convert from single mode to multiple mode, the security appliance converts the running configuration into two files: a new startup configuration that comprises the system configuration, and admin.cfg that comprises the admin context (in the root directory of the internal Flash memory). The original running configuration is saved as old\_running.cfg (in the root directory of the internal Flash memory). The original startup configuration is not saved. The security appliance automatically adds an entry for the admin context to the system configuration with the name “admin.”

To enable multiple mode, enter the following command:

```
hostname(config)# mode multiple
```

You are prompted to reboot the security appliance.

## Restoring Single Context Mode

If you convert from multiple mode to single mode, you might want to first copy a full startup configuration (if available) to the security appliance; the system configuration inherited from multiple mode is not a complete functioning configuration for a single mode device. Because the system configuration does not have any network interfaces as part of its configuration, you must access the security appliance from the console to perform the copy.

To copy the old running configuration to the startup configuration and to change the mode to single mode, perform the following steps in the system execution space:

- 
- Step 1** To copy the backup version of your original running configuration to the current startup configuration, enter the following command in the system execution space:

```
hostname(config)# copy flash:old_running.cfg startup-config
```

- Step 2** To set the mode to single mode, enter the following command in the system execution space:

```
hostname(config)# mode single
```

The security appliance reboots.

---





## Configuring Ethernet Settings and Subinterfaces

This chapter describes how to configure and enable physical Ethernet interfaces and how to add subinterfaces. If you have the 4GE SSM for the ASA 5000 series adaptive security appliance, this chapter describes how to configure the interface media type.

In single context mode, complete the procedures in this chapter and then continue your interface configuration in [Chapter 6, “Configuring Interface Parameters.”](#) In multiple context mode, complete the procedures in this chapter in the system execution space, then assign interfaces and subinterfaces to contexts according to [Chapter 5, “Adding and Managing Security Contexts,”](#) and finally configure the interface parameters within each context according to [Chapter 6, “Configuring Interface Parameters.”](#)

This chapter includes the following sections:

- [Configuring and Enabling RJ-45 Interfaces, page 4-1](#)
- [Configuring and Enabling Fiber Interfaces on the 4GE SSM, page 4-2](#)
- [Configuring and Enabling Subinterfaces, page 4-3](#)

### Configuring and Enabling RJ-45 Interfaces

This section describes how to configure Ethernet settings for physical interfaces, and how to enable the interface. By default, all physical interfaces are shut down. You must enable the physical interface before any traffic can pass through it or through a subinterface. For multiple context mode, if you allocate a physical interface or subinterface to a context, the interfaces are enabled by default in the context. However, before traffic can pass through the context interface, you must also enable the interface in the system configuration according to this procedure.

By default, the speed and duplex for copper (RJ-45) interfaces are set to auto-negotiate.

The 4GE SSM for the ASA 5000 series adaptive security appliance includes two connector types: copper RJ-45 and fiber SFP. RJ-45 is the default. If you want to configure the 4GE SSM to use the fiber SFP connectors, see the [“Configuring and Enabling Fiber Interfaces on the 4GE SSM”](#) section on page 4-2.

For RJ-45 interfaces on the ASA 5500 series adaptive security appliance, the default auto-negotiation setting also includes the Auto-MDI/MDIX feature. Auto-MDI/MDIX eliminates the need for crossover cabling by performing an internal crossover when a straight cable is detected during the auto-negotiation phase. Either the speed or duplex must be set to auto-negotiate to enable Auto-MDI/MDIX for the interface. If you explicitly set both the speed and duplex to a fixed value, thus disabling auto-negotiation for both settings, then Auto-MDI/MDIX is also disabled.

To enable the interface, or to set a specific speed and duplex, perform the following steps:

**Step 1** To specify the interface you want to configure, enter the following command:

```
hostname(config)# interface physical_interface
```

The *physical\_interface* ID includes the type, slot, and port number as *type[slot/port]*.

The physical interface types include the following:

- **ethernet**
- **gigabitethernet**

For the PIX 500 series security appliance, enter the type followed by the port number, for example, **ethernet0**.

For the ASA 5500 series adaptive security appliance, enter the type followed by slot/port, for example, **gigabitethernet0/1**. Interfaces that are built into the chassis are assigned to slot 0, while interfaces on the 4GE SSM are assigned to slot 1.

The ASA 5500 series adaptive security appliance also includes the following type:

- **management**

The management interface is a Fast Ethernet interface designed for management traffic only, and is specified as **management0/0**. You can, however, use it for through traffic if desired (see the **management-only** command). In transparent firewall mode, you can use the management interface in addition to the two interfaces allowed for through traffic. You can also add subinterfaces to the management interface to provide management in each security context for multiple context mode.

**Step 2** (Optional) To set the speed, enter the following command:

```
hostname(config-if)# speed {auto | 10 | 100 | 1000 | nonegotiate}
```

The **auto** setting is the default. The **speed nonegotiate** command disables link negotiation.

**Step 3** (Optional) To set the duplex, enter the following command:

```
hostname(config-if)# duplex {auto | full | half}
```

The **auto** setting is the default.

**Step 4** To enable the interface, enter the following command:

```
hostname(config-if)# no shutdown
```

To disable the interface, enter the **shutdown** command. If you enter the **shutdown** command for a physical interface, you also shut down all subinterfaces. If you shut down an interface in the system execution space, then that interface is shut down in all contexts that share it.

## Configuring and Enabling Fiber Interfaces on the 4GE SSM

This section describes how to configure Ethernet settings for physical interfaces, and how to enable the interface. By default, all physical interfaces are shut down. You must enable the physical interface before any traffic can pass through it or through a subinterface. For multiple context mode, if you allocate a physical interface or subinterface to a context, the interfaces are enabled by default in the context. However, before traffic can pass through the context interface, you must also enable the interface in the system configuration according to this procedure.

By default, the connectors used on the 4GE SSM are the RJ-45 connectors. To use the fiber SFP connectors, you must set the media type to SFP. The fiber interface has a fixed speed and does not support duplex, but you can set the interface to negotiate link parameters (the default) or not to negotiate.

To enable the interface, set the media type, or to set negotiation settings, perform the following steps:

---

**Step 1** To specify the interface you want to configure, enter the following command:

```
hostname(config)# interface gigabitethernet 1/port
```

The 4GE SSM interfaces are assigned to slot 1, as shown in the interface ID in the syntax (the interfaces built into the chassis are assigned to slot 0).

**Step 2** To set the media type to SFP, enter the following command:

```
hostname(config-if)# media-type sfp
```

To restore the default RJ-45, enter the **media-type rj45** command.

**Step 3** (Optional) To disable link negotiation, enter the following command:

```
hostname(config-if)# speed nonegotiate
```

For fiber Gigabit Ethernet interfaces, the default is **no speed nonegotiate**, which sets the speed to 1000 Mbps and enables link negotiation for flow-control parameters and remote fault information. The **speed nonegotiate** command disables link negotiation.

**Step 4** To enable the interface, enter the following command:

```
hostname(config-if)# no shutdown
```

To disable the interface, enter the **shutdown** command. If you enter the **shutdown** command for a physical interface, you also shut down all subinterfaces. If you shut down an interface in the system execution space, then that interface is shut down in all contexts that share it.

---

## Configuring and Enabling Subinterfaces

This section describes how to configure and enable a subinterface. You must enable the physical interface before any traffic can pass through an enabled subinterface (see the [“Configuring and Enabling RJ-45 Interfaces”](#) section on page 4-1 or the [“Configuring and Enabling Fiber Interfaces on the 4GE SSM”](#) section on page 4-2). For multiple context mode, if you allocate a subinterface to a context, the interfaces are enabled by default in the context. However, before traffic can pass through the context interface, you must also enable the interface in the system configuration with this procedure.

Subinterfaces let you divide a physical interface into multiple logical interfaces that are tagged with different VLAN IDs. Because VLANs allow you to keep traffic separate on a given physical interface, you can increase the number of interfaces available to your network without adding additional physical interfaces or security appliances. This feature is particularly useful in multiple context mode so you can assign unique interfaces to each context.

To determine how many subinterfaces are allowed for your platform, see [Appendix A, “Feature Licenses and Specifications.”](#)

**Note**

---

If you use subinterfaces, you typically do not also want the physical interface to pass traffic, because the physical interface passes untagged packets. Because the physical interface must be enabled for the subinterface to pass traffic, ensure that the physical interface does not pass traffic by leaving out the **nameif** command. If you want to let the physical interface pass untagged packets, you can configure the **nameif** command as usual. See the “[Configuring Interface Parameters](#)” section on page 6-1 for more information about completing the interface configuration.

---

To add a subinterface and assign a VLAN to it, perform the following steps:

---

**Step 1** To specify the new subinterface, enter the following command:

```
hostname(config)# interface physical_interface.subinterface
```

See the “[Configuring and Enabling RJ-45 Interfaces](#)” section for a description of the physical interface ID.

The *subinterface* ID is an integer between 1 and 4294967293.

For example, enter the following command:

```
hostname(config)# interface gigabitethernet0/1.100
```

**Step 2** To specify the VLAN for the subinterface, enter the following command:

```
hostname(config-subif)# vlan vlan_id
```

The *vlan\_id* is an integer between 1 and 4094. Some VLAN IDs might be reserved on connected switches, so check the switch documentation for more information.

You can only assign a single VLAN to a subinterface, and not to the physical interface. Each subinterface must have a VLAN ID before it can pass traffic. To change a VLAN ID, you do not need to remove the old VLAN ID with the **no** option; you can enter the **vlan** command with a different VLAN ID, and the security appliance changes the old ID.

**Step 3** To enable the subinterface, enter the following command:

```
hostname(config-subif)# no shutdown
```

To disable the interface, enter the **shutdown** command. If you shut down an interface in the system execution space, then that interface is shut down in all contexts that share it.

---





## Adding and Managing Security Contexts

---

This chapter describes how to configure multiple security contexts on the security appliance, and includes the following sections:

- [Configuring a Security Context, page 5-1](#)
- [Removing a Security Context, page 5-5](#)
- [Changing the Admin Context, page 5-5](#)
- [Changing Between Contexts and the System Execution Space, page 5-5](#)
- [Changing the Security Context URL, page 5-6](#)
- [Reloading a Security Context, page 5-7](#)
- [Monitoring Security Contexts, page 5-8](#)

For information about how contexts work and how to enable multiple context mode, see [Chapter 3](#), “Enabling Multiple Context Mode.”

### Configuring a Security Context

The security context definition in the system configuration identifies the context name, configuration file URL, and interfaces that a context can use.



#### Note

If you do not have an admin context (for example, if you clear the configuration) then you must first specify the admin context name by entering the following command:

```
hostname(config)# admin-context name
```

Although this context name does not exist yet in your configuration, you can subsequently enter the **context name** command to match the specified name to continue the admin context configuration.

---

To add or change a context in the system configuration, perform the following steps:

**Step 1** To add or modify a context, enter the following command in the system execution space:

```
hostname(config)# context name
```

The *name* is a string up to 32 characters long. This name is case sensitive, so you can have two contexts named “customerA” and “CustomerA,” for example. You can use letters, digits, or hyphens, but you cannot start or end the name with a hyphen.

“System” or “Null” (in upper or lower case letters) are reserved names, and cannot be used.

**Step 2** (Optional) To add a description for this context, enter the following command:

```
hostname(config-ctx)# description text
```

**Step 3** To specify the interfaces you can use in the context, enter the command appropriate for a physical interface or for one or more subinterfaces.

- To allocate a physical interface, enter the following command:

```
hostname(config-ctx)# allocate-interface physical_interface [map_name]
[visible | invisible]
```

- To allocate one or more subinterfaces, enter the following command:

```
hostname(config-ctx)# allocate-interface
physical_interface.subinterface[-physical_interface.subinterface]
[map_name[-map_name]] [visible | invisible]
```

You can enter these commands multiple times to specify different ranges.

Transparent firewall mode allows only two interfaces to pass through traffic; however, on the ASA adaptive security appliance, you can use the dedicated management interface, Management 0/0, (either the physical interface or a subinterface) as a third interface for management traffic.



**Note**

The management interface for transparent mode does not flood a packet out the interface when that packet is not in the MAC address table.

You can assign the same interfaces to multiple contexts in routed mode, if desired. Transparent mode does not allow shared interfaces.

The *map\_name* is an alphanumeric alias for the interface that can be used within the context instead of the interface ID. If you do not specify a mapped name, the interface ID is used within the context. For security purposes, you might not want the context administrator to know which interfaces are being used by the context.

A mapped name must start with a letter, end with a letter or digit, and have as interior characters only letters, digits, or an underscore. For example, you can use the following names:

```
int0
```

```
inta
```

```
int_0
```

For subinterfaces, you can specify a range of mapped names.

If you specify a range of subinterfaces, you can specify a matching range of mapped names. Follow these guidelines for ranges:

- The mapped name must consist of an alphabetic portion followed by a numeric portion. The alphabetic portion of the mapped name must match for both ends of the range. For example, enter the following range:

```
int0-int10
```

If you enter **gigabitethernet0/1.1-gigabitethernet0/1.5 happy1-sad5**, for example, the command fails.

- The numeric portion of the mapped name must include the same quantity of numbers as the subinterface range. For example, both ranges include 100 interfaces:

```
gigabitethernet0/0.100-gigabitethernet0/0.199 int1-int100
```

If you enter **gigabitethernet0/0.100-gigabitethernet0/0.199 int1-int15**, for example, the command fails.

Specify **visible** to see physical interface properties in the **show interface** command even if you set a mapped name. The default **invisible** keyword specifies to only show the mapped name.

The following example shows gigabitethernet0/1.100, gigabitethernet0/1.200, and gigabitethernet0/2.300 through gigabitethernet0/1.305 assigned to the context. The mapped names are int1 through int8.

```
hostname(config-ctx)# allocate-interface gigabitethernet0/1.100 int1
hostname(config-ctx)# allocate-interface gigabitethernet0/1.200 int2
hostname(config-ctx)# allocate-interface gigabitethernet0/2.300-gigabitethernet0/2.305
int3-int8
```

- Step 4** To identify the URL from which the system downloads the context configuration, enter the following command:

```
hostname(config-ctx)# config-url url
```

When you add a context URL, the system immediately loads the context so that it is running.



**Note**

Enter the **allocate-interface** command(s) before you enter the **config-url** command. The security appliance must assign interfaces to the context before it loads the context configuration; the context configuration might include commands that refer to interfaces (**interface**, **nat**, **global**...). If you enter the **config-url** command first, the security appliance loads the context configuration immediately. If the context contains any commands that refer to interfaces, those commands fail.

See the following URL syntax:

- **disk0:/[path]/filename**  
For the ASA 5500 series adaptive security appliance, this URL indicates the internal Flash memory. You can also use **flash** instead of **disk0**; they are aliased.
- **disk1:/[path]/filename**  
For the ASA 5500 series adaptive security appliance, this URL indicates the external Flash memory card.
- **flash:/[path]/filename**  
This URL indicates the internal Flash memory.
- **ftp://[user[:password]@]server[:port]/[path]/filename[:type=xx]**

The **type** can be one of the following keywords:

- **ap**—ASCII passive mode
- **an**—ASCII normal mode
- **ip**—(Default) Binary passive mode
- **in**—Binary normal mode
- **http[s]://[user[:password]@]server[:port]/[path/]filename**
- **tftp://[user[:password]@]server[:port]/[path/]filename[;int=interface\_name]**

Specify the interface name if you want to override the route to the server address.

The filename does not require a file extension, although we recommend using “.cfg”.

The admin context file must be stored on the internal Flash memory.

If you download a context configuration from an HTTP or HTTPS server, you cannot save changes back to these servers using the **copy running-config startup-config** command. You can, however, use the **copy tftp** command to copy the running configuration to a TFTP server.

If the system cannot retrieve the context configuration file because the server is unavailable, or the file does not yet exist, the system creates a blank context that is ready for you to configure with the command-line interface.

To change the URL, reenter the **config-url** command with a new URL.

See the “[Changing the Security Context URL](#)” section on page 5-6 for more information about changing the URL.

For example, enter the following command:

```
hostname(config-ctx) # config-url ftp://joe:passw0rd1@10.1.1.1/configlets/test.cfg
```

**Step 5** To view context information, see the **show context** command in the *Cisco Security Appliance Command Reference*.

The following example sets the admin context to be “administrator,” creates a context called “administrator” on the internal Flash memory, and then adds two contexts from an FTP server:

```
hostname(config)# admin-context administrator
hostname(config)# context administrator
hostname(config-ctx)# allocate-interface gigabitethernet0/0.1
hostname(config-ctx)# allocate-interface gigabitethernet0/1.1
hostname(config-ctx)# config-url flash:/admin.cfg

hostname(config-ctx)# context test
hostname(config-ctx)# allocate-interface gigabitethernet0/0.100 int1
hostname(config-ctx)# allocate-interface gigabitethernet0/0.102 int2
hostname(config-ctx)# allocate-interface gigabitethernet0/0.110-gigabitethernet0/0.115
int3-int8
hostname(config-ctx)# config-url ftp://user1:passw0rd@10.1.1.1/configlets/test.cfg

hostname(config-ctx)# context sample
hostname(config-ctx)# allocate-interface gigabitethernet0/1.200 int1
hostname(config-ctx)# allocate-interface gigabitethernet0/1.212 int2
hostname(config-ctx)# allocate-interface gigabitethernet0/1.230-gigabitethernet0/1.235
int3-int8
hostname(config-ctx)# config-url ftp://user1:passw0rd@10.1.1.1/configlets/sample.cfg
```

## Removing a Security Context

You can only remove a context by editing the system configuration. You cannot remove the current admin context, unless you remove all contexts using the **clear context** command.

**Note**

If you use failover, there is a delay between when you remove the context on the active unit and when the context is removed on the standby unit. You might see an error message indicating that the number of interfaces on the active and standby units are not consistent; this error is temporary and can be ignored.

Use the following commands for removing contexts:

- To remove a single context, enter the following command in the system execution space:

```
hostname(config)# no context name
```

All context commands are also removed.

- To remove all contexts (including the admin context), enter the following command in the system execution space:

```
hostname(config)# clear context
```

## Changing the Admin Context

You can set any context to be the admin context, as long as the configuration file is stored in the internal Flash memory. To set the admin context, enter the following command in the system execution space:

```
hostname(config)# admin-context context_name
```

Any remote management sessions, such as Telnet, SSH, or HTTPS, that are connected to the admin context are terminated. You must reconnect to the new admin context.

**Note**

A few system commands, including **ntp server**, identify an interface name that belongs to the admin context. If you change the admin context, and that interface name does not exist in the new admin context, be sure to update any system commands that refer to the interface.

## Changing Between Contexts and the System Execution Space

If you log in to the system execution space (or the admin context using Telnet or SSH), you can change between contexts and perform configuration and monitoring tasks within each context. The running configuration that you edit in a configuration mode, or that is used in the **copy** or **write** commands, depends on your location. When you are in the system execution space, the running configuration consists only of the system configuration; when you are in a context, the running configuration consists only of that context. For example, you cannot view all running configurations (system plus all contexts) by entering the **show running-config** command. Only the current configuration displays.

To change between the system execution space and a context, or between contexts, see the following commands:

- To change to a context, enter the following command:

```
hostname# changeto context name
```

The prompt changes to the following:

```
hostname/name#
```

- To change to the system execution space, enter the following command:

```
hostname/admin# changeto system
```

The prompt changes to the following:

```
hostname#
```

## Changing the Security Context URL

You cannot change the security context URL without reloading the configuration from the new URL.

The security appliance merges the new configuration with the current running configuration. Reentering the same URL also merges the saved configuration with the running configuration. A merge adds any new commands from the new configuration to the running configuration. If the configurations are the same, no changes occur. If commands conflict or if commands affect the running of the context, then the effect of the merge depends on the command. You might get errors, or you might have unexpected results. If the running configuration is blank (for example, if the server was unavailable and the configuration was never downloaded), then the new configuration is used. If you do not want to merge the configurations, you can clear the running configuration, which disrupts any communications through the context, and then reload the configuration from the new URL.

To change the URL for a context, perform the following steps:

- 
- Step 1** If you do not want to merge the configuration, change to the context and clear its configuration by entering the following commands. If you want to perform a merge, skip to Step 2.

```
hostname# changeto context name
hostname/name# configure terminal
hostname/name(config)# clear configure all
```

- Step 2** If required, change to the system execution space by entering the following command:

```
hostname/name(config)# changeto system
```

- Step 3** To enter the context configuration mode for the context you want to change, enter the following command:

```
hostname(config)# context name
```

- Step 4** To enter the new URL, enter the following command:

```
hostname(config)# config-url new_url
```

The system immediately loads the context so that it is running.

---

# Reloading a Security Context

You can reload the context in two ways:

- Clear the running configuration and then import the startup configuration.  
This action clears most attributes associated with the context, such as connections and NAT tables.
- Remove the context from the system configuration.  
This action clears additional attributes, such as memory allocation, which might be useful for troubleshooting. However, to add the context back to the system requires you to respecify the URL and interfaces.

This section includes the following topics:

- [Reloading by Clearing the Configuration, page 5-7](#)
- [Reloading by Removing and Re-adding the Context, page 5-7](#)

## Reloading by Clearing the Configuration

To reload the context by clearing the context configuration, and reloading the configuration from the URL, perform the following steps:

---

**Step 1** To change to the context that you want to reload, enter the following command:

```
hostname# changeto context name
```

**Step 2** To access configuration mode, enter the following command:

```
hostname/name# configure terminal
```

**Step 3** To clear the running configuration, enter the following command:

```
hostname/name(config)# clear configure all
```

This command clears all connections.

**Step 4** To reload the configuration, enter the following command:

```
hostname/name(config)# copy startup-config running-config
```

The security appliance copies the configuration from the URL specified in the system configuration. You cannot change the URL from within a context.

---

## Reloading by Removing and Re-adding the Context

To reload the context by removing the context and then re-adding it, perform the steps in the following sections:

1. [“Removing a Security Context” section on page 5-5](#)
2. [“Configuring a Security Context” section on page 5-1](#)

# Monitoring Security Contexts

This section describes how to view and monitor context information, and includes the following topics:

- [Viewing Context Information, page 5-8](#)
- [Viewing Resource Usage, page 5-9](#)

## Viewing Context Information

From the system execution space, you can view a list of contexts including the name, allocated interfaces, and configuration file URL.

From the system execution space, view all contexts by entering the following command:

```
hostname# show context [name | detail| count]
```

The **detail** option shows additional information. See the following sample displays below for more information.

If you want to show information for a particular context, specify the *name*.

The **count** option shows the total number of contexts.

The following is sample output from the **show context** command. The following sample display shows three contexts:

```
hostname# show context

Context Name Interfaces URL
*admin GigabitEthernet0/1.100 flash:/admin.cfg
 GigabitEthernet0/1.101
contexta GigabitEthernet0/1.200 flash:/contexta.cfg
 GigabitEthernet0/1.201
contextb GigabitEthernet0/1.300 flash:/contextb.cfg
 GigabitEthernet0/1.301
Total active Security Contexts: 3
```

[Table 5-1](#) shows each field description.

**Table 5-1** *show context Fields*

| Field        | Description                                                                           |
|--------------|---------------------------------------------------------------------------------------|
| Context Name | Lists all context names. The context name with the asterisk (*) is the admin context. |
| Interfaces   | The interfaces assigned to the context.                                               |
| URL          | The URL from which the security appliance loads the context configuration.            |

The following is sample output from the **show context detail** command:

```
hostname# show context detail

Context "admin", has been created, but initial ACL rules not complete
 Config URL: flash:/admin.cfg
 Real Interfaces: Management0/0
 Mapped Interfaces: Management0/0
 Flags: 0x00000013, ID: 1

Context "ctx", has been created, but initial ACL rules not complete
 Config URL: ctx.cfg
```



```

Real Interfaces: GigabitEthernet0/0.10, GigabitEthernet0/1.20,
 GigabitEthernet0/2.30
Mapped Interfaces: int1, int2, int3
Flags: 0x00000011, ID: 2

Context "system", is a system resource
Config URL: startup-config
Real Interfaces:
Mapped Interfaces: Control0/0, GigabitEthernet0/0,
 GigabitEthernet0/0.10, GigabitEthernet0/1, GigabitEthernet0/1.10,
 GigabitEthernet0/1.20, GigabitEthernet0/2, GigabitEthernet0/2.30,
 GigabitEthernet0/3, Management0/0, Management0/0.1
Flags: 0x00000019, ID: 257

Context "null", is a system resource
Config URL: ... null ...
Real Interfaces:
Mapped Interfaces:
Flags: 0x00000009, ID: 258

```

See the *Cisco Security Appliance Command Reference* for more information about the **detail** output.

The following is sample output from the **show context count** command:

```

hostname# show context count
Total active contexts: 2

```

## Viewing Resource Usage

From the system execution space, you can view the resource usage for each context and display the system resource usage. Resources include concurrent connections, Telnet sessions, SSH sessions, hosts, NAT translations, and for single mode, IPsec sessions.

From the system execution space, view the resource usage for each context by entering the following command:

```

hostname# show resource usage [context context_name | top n | all | summary | system]
[resource {resource_name | all}] [counter counter_name [count_threshold]]

```

By default, **all** context usage is displayed; each context is listed separately.

Enter the **top n** keyword to show the contexts that are the top *n* users of the specified resource. You must specify a single resource type, and not **resource all**, with this option.

The **summary** option shows all context usage combined.

The **system** option shows all context usage combined, but shows the system limits for resources instead of the combined context limits.

The **resource** names include the following values. See also the **show resource type** command for a complete list. Specify **all** (the default) for all types.

- **conns**—TCP or UDP connections between any two hosts, including connections between one host and multiple other hosts.
- **hosts**—Hosts that can connect through the security appliance.
- **ipsec**—(Single mode only) IPsec sessions.
- **ssh**—SSH sessions.
- **telnet**—Telnet sessions.
- **xlates**—NAT translations.

The **counter** *counter\_name* is one of the following keywords:

- **current**—Shows the active concurrent instances or the current rate of the resource.
- **peak**—Shows the peak concurrent instances, or the peak rate of the resource since the statistics were last cleared, either using the **clear resource usage** command or because the device rebooted.
- **all**—(Default) Shows all statistics.

The *count\_threshold* sets the number above which resources are shown. The default is 1. If the usage of the resource is below the number you set, then the resource is not shown. If you specify **all** for the counter name, then the *count\_threshold* applies to the current usage.



**Note**

To show all resources, set the *count\_threshold* to **0**.

The following is sample output from the **show resource usage context** command, which shows the resource usage for the admin context:

```
hostname# show resource usage context admin

Resource Current Peak Limit Context
Telnet 1 1 5 admin
Conns 44 55 N/A admin
Hosts 45 56 N/A admin
```

The following is sample output from the **show resource usage summary** command, which shows the resource usage for all contexts and all resources. This sample shows the limits for 6 contexts.

```
hostname# show resource usage summary

Resource Current Peak Limit Context
Telnet 3 5 30 Summary
SSH 5 7 30 Summary
Conns 40 55 N/A Summary
Hosts 44 56 N/A Summary
```

The following is sample output from the **show resource usage summary** command, which shows the limits for 25 contexts. Because the context limit for Telnet and SSH connections is 5 per context, then the combined limit is 125. The system limit is only 100, so the system limit is shown.

```
hostname# show resource usage summary

Resource Current Peak Limit Context
Telnet 1 1 100[S] Summary
SSH 2 2 100[S] Summary
Conns 56 90 N/A Summary
Hosts 89 102 N/A Summary
S = System limit: Combined context limits exceed the system limit; the system limit is shown.
```

The following is sample output from the **show resource usage system** command, which shows the resource usage for all contexts, but it shows the system limit instead of the combined context limits:

```
hostname# show resource usage system

Resource Current Peak Limit Context
Telnet 3 5 100 System
SSH 5 7 100 System
Conns 40 55 N/A System
Hosts 44 56 N/A System
```



## Configuring Interface Parameters

---

This chapter describes how to configure each interface and subinterface for a name, security, level, and IP address. For single context mode, the procedures in this chapter continue the interface configuration started in [Chapter 4, “Configuring Ethernet Settings and Subinterfaces.”](#) For multiple context mode, the procedures in [Chapter 4, “Configuring Ethernet Settings and Subinterfaces,”](#) are performed in the system execution space, while the procedures in this chapter are performed within each security context.

This chapter includes the following sections:

- [Security Level Overview, page 6-1](#)
- [Configuring the Interface, page 6-2](#)
- [Allowing Communication Between Interfaces on the Same Security Level, page 6-5](#)

### Security Level Overview

Each interface must have a security level from 0 (lowest) to 100 (highest). For example, you should assign your most secure network, such as the inside host network, to level 100. While the outside network connected to the Internet can be level 0. Other networks, such as DMZs can be in between. You can assign interfaces to the same security level. See the [“Allowing Communication Between Interfaces on the Same Security Level”](#) section on [page 6-5](#) for more information.

The level controls the following behavior:

- Network access—By default, there is an implicit permit from a higher security interface to a lower security interface (outbound). Hosts on the higher security interface can access any host on a lower security interface. You can limit access by applying an access list to the interface.  
If you enable communication for same security interfaces (see the [“Allowing Communication Between Interfaces on the Same Security Level”](#) section on [page 6-5](#)), there is an implicit permit for interfaces to access other interfaces on the same security level or lower.
- Inspection engines—Some inspection engines are dependent on the security level. For same security interfaces, inspection engines apply to traffic in either direction.
  - NetBIOS inspection engine—Applied only for outbound connections.
  - OraServ inspection engine—If a control connection for the OraServ port exists between a pair of hosts, then only an inbound data connection is permitted through the security appliance.
- Filtering—HTTP(S) and FTP filtering applies only for outbound connections (from a higher level to a lower level).

For same security interfaces, you can filter traffic in either direction.

- NAT control—When you enable NAT control, you must configure NAT for hosts on a higher security interface (inside) when they access hosts on a lower security interface (outside).

Without NAT control, or for some security interfaces, you can choose to use NAT between any interface, or you can choose not to use NAT. Keep in mind that configuring NAT for an outside interface might require a special keyword.

- **established** command—This command allows return connections from a lower security host to a higher security host if there is already an established connection from the higher level host to the lower level host.

For some security interfaces, you can configure **established** commands for both directions.

## Configuring the Interface

By default, all physical interfaces are shut down. You must enable the physical interface before any traffic can pass through an enabled subinterface. For multiple context mode, if you allocate a physical interface or subinterface to a context, the interfaces are enabled by default in the context. However, before traffic can pass through the context interface, you must also enable the interface in the system configuration. If you shut down an interface in the system execution space, then that interface is down in all contexts that share it.

Before you can complete your configuration and allow traffic through the security appliance, you need to configure an interface name, and for routed mode, an IP address. You should also change the security level from the default, which is 0. If you name an interface “inside” and you do not set the security level explicitly, then the security appliance sets the security level to 100.



### Note

If you are using failover, do not use this procedure to name interfaces that you are reserving for failover and Stateful Failover communications. See [Chapter 11, “Configuring Failover.”](#) to configure the failover and state links.

For multiple context mode, follow these guidelines:

- Configure the context interfaces from within each context.
- You can only configure context interfaces that you already assigned to the context in the system configuration.
- The system configuration only lets you configure Ethernet settings and VLANs. The exception is for failover interfaces; do not configure failover interfaces with this procedure. See the Failover chapter for more information.



### Note

If you change the security level of an interface, and you do not want to wait for existing connections to time out before the new security information is used, you can clear the connections using the **clear local-host** command.

To configure an interface or subinterface, perform the following steps:

- Step 1** To specify the interface you want to configure, enter the following command:

```
hostname(config)# interface {physical_interface[.subinterface] | mapped_name}
```

The *physical\_interface* ID includes the type, slot, and port number as *type[slot/port]*.

The physical interface types include the following:

- **ethernet**
- **gigabitethernet**

For the PIX 500 series security appliance, enter the type followed by the port number, for example, **ethernet0**.

For the ASA 5500 series adaptive security appliance, enter the type followed by slot/port, for example, **gigabitethernet0/1**. Interfaces that are built into the chassis are assigned to slot 0, while interfaces on the 4GE SSM are assigned to slot 1.

The ASA 5500 series adaptive security appliance also includes the following type:

- **management**

The management interface is a Fast Ethernet interface designed for management traffic only, and is specified as **management0/0**. You can, however, use it for through traffic if desired (see the **management-only** command). In transparent firewall mode, you can use the management interface in addition to the two interfaces allowed for through traffic. You can also add subinterfaces to the management interface to provide management in each security context for multiple context mode.

Append the *subinterface* ID to the physical interface ID separated by a period (.).

In multiple context mode, enter the mapped name if one was assigned using the **allocate-interface** command.

For example, enter the following command:

```
hostname(config)# interface gigabitethernet0/1.1
```

**Step 2** To name the interface, enter the following command:

```
hostname(config-if)# nameif name
```

The *name* is a text string up to 48 characters, and is not case-sensitive. You can change the name by reentering this command with a new value. Do not enter the **no** form, because that command causes all commands that refer to that name to be deleted.

**Step 3** To set the security level, enter the following command:

```
hostname(config-if)# security-level number
```

Where *number* is an integer between 0 (lowest) and 100 (highest).

**Step 4** To set the IP address or routed mode only, enter one of the following commands.



**Note** To set an IPv6 address, see the “Configuring IPv6 on an Interface” section on page 9-2.

- To set the IP address manually, enter the following command:

```
hostname(config-if)# ip address ip_address [mask] [standby ip_address]
```

The **standby** keyword and address is used for failover. See [Chapter 11, “Configuring Failover,”](#) for more information.

- To obtain an IP address from a DHCP server, enter the following command:

```
hostname(config-if)# ip address dhcp [setroute]
```

Reenter this command to reset the DHCP lease and request a new lease.

You cannot set this command at the same time as the **ip address** command.

If you enable the **setroute** option, do not configure a default route using the **static** command.

If you do not enable the interface using the **no shutdown** command before you enter the **ip address dhcp** command, some DHCP requests might not be sent.

**Step 5** To set an interface to management-only mode, enter the following command:

```
hostname(config-if)# management-only
```

The ASA 5000 series adaptive security appliance includes a dedicated management interface called Management 0/0, which is meant to support traffic to the security appliance. However, you can configure any interface to be a management-only interface using the **management-only** command. Also, for Management 0/0, you can disable management-only mode so the interface can pass through traffic just like any other interface.



**Note** Transparent firewall mode allows only two interfaces to pass through traffic; however, on the ASA 5000 series adaptive security appliance, you can use the dedicated management interface (either the physical interface or a subinterface) as a third interface for management traffic. The mode is not configurable in this case and must always be management-only.

**Step 6** To enable the interface, if it is not already enabled, enter the following command:

```
hostname(config-if)# no shutdown
```

To disable the interface, enter the **shutdown** command. If you enter the **shutdown** command for a physical interface, you also shut down all subinterfaces. If you shut down an interface in the system execution space, then that interface is shut down in all contexts that share it, even though the context configurations show the interface as enabled.

The following example configures parameters for the physical interface in single mode:

```
hostname(config)# interface gigabitethernet0/1
hostname(config-if)# speed 1000
hostname(config-if)# duplex full
hostname(config-if)# nameif inside
hostname(config-if)# security-level 100
hostname(config-if)# ip address 10.1.1.1 255.255.255.0
hostname(config-if)# no shutdown
```

The following example configures parameters for a subinterface in single mode:

```
hostname(config)# interface gigabitethernet0/1.1
hostname(config-subif)# vlan 101
hostname(config-subif)# nameif dmz1
hostname(config-subif)# security-level 50
hostname(config-subif)# ip address 10.1.2.1 255.255.255.0
hostname(config-subif)# no shutdown
```

The following example configures interface parameters in multiple context mode for the system configuration, and allocates the gigabitethernet 0/1.1 subinterface to contextA:

```
hostname(config)# interface gigabitethernet0/1
hostname(config-if)# speed 1000
hostname(config-if)# duplex full
hostname(config-if)# no shutdown
hostname(config-if)# interface gigabitethernet0/1.1
hostname(config-subif)# vlan 101
hostname(config-subif)# no shutdown
hostname(config-subif)# context contextA
hostname(config-ctx)# ...
```

```
hostname(config-ctx)# allocate-interface gigabitethernet0/1.1
```

The following example configures parameters in multiple context mode for the context configuration:

```
hostname/contextA(config)# interface gigabitethernet0/1.1
hostname/contextA(config-if)# nameif inside
hostname/contextA(config-if)# security-level 100
hostname/contextA(config-if)# ip address 10.1.2.1 255.255.255.0
hostname/contextA(config-if)# no shutdown
```

## Allowing Communication Between Interfaces on the Same Security Level

By default, interfaces on the same security level cannot communicate with each other. Allowing communication between same security interfaces provides the following benefits:

- You can configure more than 101 communicating interfaces.  
If you use different levels for each interface and do not assign any interfaces to the same security level, you can configure only one interface per level (0 to 100).
- You want traffic to flow freely between all same security interfaces without access lists.



### Note

If you enable NAT control, you do not need to configure NAT between same security level interfaces. See the [“NAT and Same Security Level Interfaces”](#) section on page 14-33 for more information on NAT and same security level interfaces.

If you enable same security interface communication, you can still configure interfaces at different security levels as usual.

To enable interfaces on the same security level so that they can communicate with each other, enter the following command:

```
hostname(config)# same-security-traffic permit inter-interface
```

To disable this setting, use the **no** form of this command.







## Configuring Basic Settings

---

This chapter describes how to configure basic settings on your security appliance that are typically required for a functioning configuration. This chapter includes the following sections:

- [Changing the Enable Password, page 7-1](#)
- [Setting the Hostname, page 7-2](#)
- [Setting the Domain Name, page 7-2](#)
- [Setting the Date and Time, page 7-2](#)
- [Setting the Management IP Address for a Transparent Firewall, page 7-5](#)

### Changing the Enable Password

The enable password lets you enter privileged EXEC mode. By default, the enable password is blank. To change the enable password, enter the following command:

```
hostname(config)# enable password password
```

The *password* is a case-sensitive password of up to 16 alphanumeric and special characters. You can use any character in the password except a question mark or a space.

This command changes the password for the highest privilege level. If you configure local command authorization, you can set enable passwords for each privilege level from 0 to 15.

The password is saved in the configuration in encrypted form, so you cannot view the original password after you enter it. Enter the **enable password** command without a password to set the password to the default, which is blank.

## Setting the Hostname

When you set a hostname for the security appliance, that name appears in the command line prompt. If you establish sessions to multiple devices, the hostname helps you keep track of where you enter commands. The default hostname depends on your platform.

For multiple context mode, the hostname that you set in the system execution space appears in the command line prompt for all contexts. The hostname that you optionally set within a context does not appear in the command line, but can be used by the **banner** command **\$(hostname)** token.

To specify the hostname for the security appliance or for a context, enter the following command:

```
hostname(config)# hostname name
```

This name can be up to 63 characters. A hostname must start and end with a letter or digit, and have as interior characters only letters, digits, or a hyphen.

.

This name appears in the command line prompt. For example:

```
hostname(config)# hostname farscape
farscape(config)#
```

## Setting the Domain Name

The security appliance appends the domain name as a suffix to unqualified names. For example, if you set the domain name to “example.com,” and specify a syslog server by the unqualified name of “jupiter,” then the security appliance qualifies the name to “jupiter.example.com.”

The default domain name is default.domain.invalid.

For multiple context mode, you can set the domain name for each context, as well as within the system execution space.

To specify the domain name for the security appliance, enter the following command:

```
hostname(config)# domain-name name
```

For example, to set the domain as example.com, enter the following command:

```
hostname(config)# domain-name example.com
```

## Setting the Date and Time

This section describes how to set the date and time, either manually or dynamically using an NTP server. Time derived from an NTP server overrides any time set manually. This section also describes how to set the time zone and daylight saving time date range.



### Note

In multiple context mode, set the time in the system configuration only.

This section includes the following topics:

- [Setting the Time Zone and Daylight Saving Time Date Range, page 7-3](#)
- [Setting the Date and Time Using an NTP Server, page 7-4](#)

- [Setting the Date and Time Manually, page 7-4](#)

## Setting the Time Zone and Daylight Saving Time Date Range

By default, the time zone is UTC and the daylight saving time date range is from 2:00 a.m. on the first Sunday in April to 2:00 a.m. on the last Sunday in October. To change the time zone and daylight saving time date range, perform the following steps:

**Step 1** To set the time zone, enter the following command in global configuration mode:

```
hostname(config)# clock timezone zone [-]hours [minutes]
```

Where *zone* specifies the time zone as a string, for example, **PST** for Pacific Standard Time.

The [-]*hours* value sets the number of hours of offset from UTC. For example, PST is **-8** hours.

The *minutes* value sets the number of minutes of offset from UTC.

**Step 2** To change the date range for daylight saving time from the default, enter one of the following commands.

The default recurring date range is from 2:00 a.m. on the first Sunday in April to 2:00 a.m. on the last Sunday in October.

- To set the start and end dates for daylight saving time as a specific date in a specific year, enter the following command:

```
hostname(config)# clock summer-time zone date {day month | month day} year hh:mm {day month | month day} year hh:mm [offset]
```

If you use this command, you need to reset the dates every year.

The *zone* value specifies the time zone as a string, for example, **PDT** for Pacific Daylight Time.

The *day* value sets the day of the month, from 1 to 31. You can enter the day and month as **April 1** or as **1 April**, for example, depending on your standard date format.

The *month* value sets the month as a string. You can enter the day and month as **April 1** or as **1 April**, for example, depending on your standard date format.

The *year* value sets the year using four digits, for example, **2004**. The year range is 1993 to 2035.

The *hh:mm* value sets the hour and minutes in 24-hour time.

The *offset* value sets the number of minutes to change the time for daylight saving time. By default, the value is 60 minutes.

- To specify the start and end dates for daylight saving time, in the form of a day and time of the month, and not a specific date in a year, enter the following command.

```
hostname(config)# clock summer-time zone recurring [week weekday month hh:mm week weekday month hh:mm] [offset]
```

This command lets you set a recurring date range that you do not need to alter yearly.

The *zone* value specifies the time zone as a string, for example, **PDT** for Pacific Daylight Time.

The *week* value specifies the week of the month as an integer between 1 and 4 or as the words **first** or **last**. For example, if the day might fall in the partial fifth week, then specify **last**.

The *weekday* value specifies the day of the week: **Monday**, **Tuesday**, **Wednesday**, and so on.

The *month* value sets the month as a string.

The *hh:mm* value sets the hour and minutes in 24-hour time.

The *offset* value sets the number of minutes to change the time for daylight saving time. By default, the value is 60 minutes.

## Setting the Date and Time Using an NTP Server

To obtain the date and time from an NTP server, perform the following steps:

**Step 1** To configure authentication with an NTP server, perform the following steps:

- a. To enable authentication, enter the following command:

```
hostname(config)# ntp authenticate
```

- b. To specify an authentication key ID to be a trusted key, which is required for authentication with an NTP server, enter the following command:

```
hostname(config)# ntp trusted-key key_id
```

Where the *key\_id* is between 1 and 4294967295. You can enter multiple trusted keys for use with multiple servers.

- c. To set a key to authenticate with an NTP server, enter the following command:

```
hostname(config)# ntp authentication-key key_id md5 key
```

Where *key\_id* is the ID you set in Step 1b using the **ntp trusted-key** command, and *key* is a string up to 32 characters in length.

**Step 2** To identify an NTP server, enter the following command:

```
hostname(config)# ntp server ip_address [key key_id] [source interface_name] [prefer]
```

Where the *key\_id* is the ID you set in [Step 1b](#) using the **ntp trusted-key** command.

The **source interface\_name** identifies the outgoing interface for NTP packets if you do not want to use the default interface in the routing table. Because the system does not include any interfaces in multiple context mode, specify an interface name defined in the admin context.

The **prefer** keyword sets this NTP server as the preferred server if multiple servers have similar accuracy. NTP uses an algorithm to determine which server is the most accurate and synchronizes to that one. If servers are of similar accuracy, then the **prefer** keyword specifies which of those servers to use. However, if a server is significantly more accurate than the preferred one, the security appliance uses the more accurate one. For example, the security appliance uses a server of stratum 2 over a server of stratum 3 that is preferred.

You can identify multiple servers; the security appliance uses the most accurate server.

## Setting the Date and Time Manually

To set the date time manually, enter the following command:

```
hostname# clock set hh:mm:ss {month day | day month} year
```

Where *hh:mm:ss* sets the hour, minutes, and seconds in 24-hour time. For example, set **20:54:00** for 8:54 pm.

The *day* value sets the day of the month, from 1 to 31. You can enter the day and month as **april 1** or as **1 april**, for example, depending on your standard date format.

The *month* value sets the month. Depending on your standard date format, you can enter the day and month as **april 1** or as **1 april**.

The *year* value sets the year using four digits, for example, **2004**. The year range is 1993 to 2035.

The default time zone is UTC. If you change the time zone after you enter the **clock set** command using the **clock timezone** command, the time automatically adjusts to the new time zone.

This command sets the time in the hardware chip, and does not save the time in the configuration file. This time endures reboots. Unlike the other **clock** commands, this command is a privileged EXEC command. To reset the clock, you need to set a new time for the **clock set** command.

## Setting the Management IP Address for a Transparent Firewall

### Transparent firewall mode only

A transparent firewall does not participate in IP routing. The only IP configuration required for the security appliance is to set the management IP address. This address is required because the security appliance uses this address as the source address for traffic originating on the security appliance, such as system messages or communications with AAA servers. You can also use this address for remote management access.

For multiple context mode, set the management IP address within each context.

To set the management IP address, enter the following command:

```
hostname(config)# ip address ip_address [mask] [standby ip_address]
```

This address must be on the same subnet as the upstream and downstream routers. You cannot set the subnet to a host subnet (255.255.255.255). This address must be IPv4; the transparent firewall does not support IPv6.

The **standby** keyword and address is used for failover. See [Chapter 11, “Configuring Failover,”](#) for more information.





# Configuring IP Routing and DHCP Services

This chapter describes how to configure IP routing and DHCP on the security appliance. This chapter includes the following sections:

- [Configuring Static and Default Routes, page 8-1](#)
- [Configuring OSPF, page 8-3](#)
- [Configuring RIP, page 8-17](#)
- [Dynamic Routing and Failover, page 8-18](#)
- [Configuring Multicast Routing, page 8-18](#)
- [Configuring DHCP, page 8-25](#)

## Configuring Static and Default Routes

This section describes how to configure static routes on the security appliance.

Multiple context mode does not support dynamic routing, so you must use static routes for any networks to which the security appliance is not directly connected; for example, when there is a router between a network and the security appliance.

You might want to use static routes in single context mode in the following cases:

- Your networks use a different router discovery protocol from RIP or OSPF.
- Your network is small and you can easily manage static routes.
- You do not want the traffic or CPU overhead associated with routing protocols.

The simplest option is to configure a default route to send all traffic to an upstream router, relying on the router to route the traffic for you. However, in some cases the default gateway might not be able to reach the destination network, so you must also configure more specific static routes. For example, if the default gateway is outside, then the default route cannot direct traffic to any inside networks that are not directly connected to the security appliance.

In transparent firewall mode, for traffic that originates on the security appliance and is destined for a non-directly connected network, you need to configure either a default route or static routes so the security appliance knows out of which interface to send traffic. Traffic that originates on the security appliance might include communications to a syslog server, Websense or N2H2 server, or AAA server. If you have servers that cannot all be reached through a single default route, then you must configure static routes.

The security appliance supports up to three equal cost routes on the same interface for load balancing.

This section includes the following topics:

- [Configuring a Static Route, page 8-2](#)
- [Configuring a Default Route, page 8-3](#)

For information about configuring IPv6 static and default routes, see the “[Configuring IPv6 Default and Static Routes](#)” section on page 9-3.

## Configuring a Static Route

To add a static route, enter the following command:

```
hostname(config)# route if_name dest_ip mask gateway_ip [distance]
```

The *dest\_ip* and *mask* is the IP address for the destination network and the *gateway\_ip* is the address of the next-hop router. The addresses you specify for the static route are the addresses that are in the packet before entering the security appliance and performing NAT.

The *distance* is the administrative distance for the route. The default is 1 if you do not specify a value. Administrative distance is a parameter used to compare routes among different routing protocols. The default administrative distance for static routes is 1, giving it precedence over routes discovered by dynamic routing protocols but not directly connect routes. The default administrative distance for routes discovered by OSPF is 110. If a static route has the same administrative distance as a dynamic route, the static routes take precedence. Connected routes always take precedence over static or dynamically discovered routes.

Static routes remain in the routing table even if the specified gateway becomes unavailable. If the specified gateway becomes unavailable, you need to remove the static route from the routing table manually. However, static routes are removed from the routing table if the specified interface goes down. They are reinstated when the interface comes back up.



### Note

If you create a static route with an administrative distance greater than the administrative distance of the routing protocol running on the security appliance, then a route to the specified destination discovered by the routing protocol takes precedence over the static route. The static route is used only if the dynamically discovered route is removed from the routing table.

The following example creates a static route that sends all traffic destined for 10.1.1.0/24 to the router (10.1.2.45) connected to the inside interface:

```
hostname(config)# route inside 10.1.1.0 255.255.255.0 10.1.2.45 1
```

You can define up to three equal cost routes to the same destination per interface. ECMP is not supported across multiple interfaces. With ECMP, the traffic is not necessarily divided evenly between the routes; traffic is distributed among the specified gateways based on an algorithm that hashes the source and destination IP addresses.

The following example shows static routes that are equal cost routes that direct traffic to three different gateways on the outside interface. The security appliance distributes the traffic among the specified gateways.

```
hostname(config)# route outside 10.10.10.0 255.255.255.0 192.168.1.1
hostname(config)# route outside 10.10.10.0 255.255.255.0 192.168.1.2
hostname(config)# route outside 10.10.10.0 255.255.255.0 192.168.1.3
```



## Configuring a Default Route

A default route identifies the gateway IP address to which the security appliance sends all IP packets for which it does not have a learned or static route. A default route is simply a static route with 0.0.0.0/0 as the destination IP address. Routes that identify a specific destination take precedence over the default route.



### Note

In ASA software Versions 7.0 and later, if you have two default routes configured on different interfaces that have different metrics, the connection to the ASA firewall that is made from the higher metric interface fails, but connections to the ASA firewall from the lower metric interface succeed as expected. PIX software Version 6.3 supports connections from both the the higher and the lower metric interfaces.

You can define up to three equal cost default route entries per device. Defining more than one equal cost default route entry causes the traffic sent to the default route to be distributed among the specified gateways. When defining more than one default route, you must specify the same interface for each entry.

If you attempt to define more than three equal cost default routes, or if you attempt to define a default route with a different interface than a previously defined default route, you receive the message “ERROR: Cannot add route entry, possible conflict with existing routes.”

You can define a separate default route for tunneled traffic along with the standard default route. When you create a default route with the **tunneled** option, all encrypted traffic that arrives on the security appliance and cannot be routed using learned or static routes is sent to this route. Otherwise, if the traffic is not encrypted, the standard default route entry is used. You cannot define more than one default route with the **tunneled** option; ECMP for tunneled traffic is not supported.

To define the default route, enter the following command:

```
hostname(config)# route if_name 0.0.0.0 0.0.0.0 gateway_ip [distance | tunneled]
```



### Tip

You can enter 0 0 instead of 0.0.0.0 0.0.0.0 for the destination network address and mask, for example:

```
hostname(config)# route outside 0 0 192.168.1 1
```

The following example shows a security appliance configured with three equal cost default routes and a default route for tunneled traffic. Unencrypted traffic received by the security appliance for which there is no static or learned route is distributed among the gateways with the IP addresses 192.168.2.1, 192.168.2.2, 192.168.2.3. Encrypted traffic receive by the security appliance for which there is no static or learned route is passed to the gateway with the IP address 192.168.2.4.

```
hostname(config)# route outside 0 0 192.168.2.1
hostname(config)# route outside 0 0 192.168.2.2
hostname(config)# route outside 0 0 192.168.2.3
hostname(config)# route outside 0 0 192.168.2.4 tunneled
```

## Configuring OSPF

This section describes how to configure OSPF. This section includes the following topics:

- [OSPF Overview, page 8-4](#)
- [Enabling OSPF, page 8-5](#)

- [Redistributing Routes Between OSPF Processes, page 8-5](#)
- [Configuring OSPF Interface Parameters, page 8-9](#)
- [Configuring OSPF Area Parameters, page 8-11](#)
- [Configuring OSPF NSSA, page 8-12](#)
- [Configuring Route Summarization Between OSPF Areas, page 8-13](#)
- [Configuring Route Summarization When Redistributing Routes into OSPF, page 8-13](#)
- [Generating a Default Route, page 8-14](#)
- [Configuring Route Calculation Timers, page 8-14](#)
- [Logging Neighbors Going Up or Down, page 8-15](#)
- [Displaying OSPF Update Packet Pacing, page 8-15](#)
- [Monitoring OSPF, page 8-16](#)
- [Restarting the OSPF Process, page 8-16](#)

## OSPF Overview

OSPF uses a link-state algorithm to build and calculate the shortest path to all known destinations. Each router in an OSPF area contains an identical link-state database, which is a list of each of the router usable interfaces and reachable neighbors.

The advantages of OSPF over RIP include the following:

- OSPF link-state database updates are sent less frequently than RIP updates, and the link-state database is updated instantly rather than gradually as stale information is timed out.
- Routing decisions are based on cost, which is an indication of the overhead required to send packets across a certain interface. The security appliance calculates the cost of an interface based on link bandwidth rather than the number of hops to the destination. The cost can be configured to specify preferred paths.

The disadvantage of shortest path first algorithms is that they require a lot of CPU cycles and memory.

The security appliance can run two processes of OSPF protocol simultaneously, on different sets of interfaces. You might want to run two processes if you have interfaces that use the same IP addresses (NAT allows these interfaces to coexist, but OSPF does not allow overlapping addresses). Or you might want to run one process on the inside, and another on the outside, and redistribute a subset of routes between the two processes. Similarly, you might need to segregate private addresses from public addresses.

Redistribution between the two OSPF processes is supported. Static and connected routes configured on OSPF-enabled interfaces on the security appliance can also be redistributed into the OSPF process. You cannot enable RIP on the security appliance if OSPF is enabled. Redistribution between RIP and OSPF is not supported.

The security appliance supports the following OSPF features:

- Support of intra-area, interarea, and external (Type I and Type II) routes.
- Support of a virtual link.
- OSPF LSA flooding.
- Authentication to OSPF packets (both password and MD5 authentication).

- Support for configuring the security appliance as a designated router or a designated backup router. The security appliance also can be set up as an ABR; however, the ability to configure the security appliance as an ASBR is limited to default information only (for example, injecting a default route).
- Support for stub areas and not-so-stubby-areas.
- Area boundary router type-3 LSA filtering.
- Advertisement of static and global address translations.

## Enabling OSPF

To enable OSPF, you need to create an OSPF routing process, specify the range of IP addresses associated with the routing process, then assign area IDs associated with that range of IP addresses.



**Note** You cannot enable OSPF if RIP is enabled.

To enable OSPF, perform the following steps:

**Step 1** To create an OSPF routing process, enter the following command:

```
hostname(config)# router ospf process_id
```

This command enters the router configuration mode for this OSPF process.

The *process\_id* is an internally used identifier for this routing process. It can be any positive integer. This ID does not have to match the ID on any other device; it is for internal use only. You can use a maximum of two processes.

**Step 2** To define the IP addresses on which OSPF runs and to define the area ID for that interface, enter the following command:

```
hostname(config-router)# network ip_address mask area area_id
```

The following example shows how to enable OSPF:

```
hostname(config)# router ospf 2
hostname(config-router)# network 10.0.0.0 255.0.0.0 area 0
```

## Redistributing Routes Between OSPF Processes

The security appliance can control the redistribution of routes between OSPF routing processes. The security appliance matches and changes routes according to settings in the **redistribute** command or by using a route map. See also the [“Generating a Default Route” section on page 8-14](#) for another use for route maps.



**Note** The security appliance cannot redistribute routes between routing protocols. However, the security appliance can redistribute static and connected routes.

This section includes the following topics:

- [Adding a Route Map, page 8-7](#)
- [Redistributing Static, Connected, or OSPF Routes to an OSPF Process, page 8-8](#)

## Adding a Route Map

To define a route map, perform the following steps:

**Step 1** To create a route map entry, enter the following command:

```
hostname(config)# route-map name {permit | deny} [sequence_number]
```

Route map entries are read in order. You can identify the order using the *sequence\_number* option, or the security appliance uses the order in which you add the entries.

**Step 2** Enter one or more **match** commands:

- To match any routes that have a destination network that matches a standard ACL, enter the following command:

```
hostname(config-route-map)# match ip address acl_id [acl_id] [...]
```

If you specify more than one ACL, then the route can match any of the ACLs.

- To match any routes that have a specified metric, enter the following command:

```
hostname(config-route-map)# match metric metric_value
```

The *metric\_value* can be from 0 to 4294967295.

- To match any routes that have a next hop router address that matches a standard ACL, enter the following command:

```
hostname(config-route-map)# match ip next-hop acl_id [acl_id] [...]
```

If you specify more than one ACL, then the route can match any of the ACLs.

- To match any routes with the specified next hop interface, enter the following command:

```
hostname(config-route-map)# match interface if_name
```

If you specify more than one interface, then the route can match either interface.

- To match any routes that have been advertised by routers that match a standard ACL, enter the following command:

```
hostname(config-route-map)# match ip route-source acl_id [acl_id] [...]
```

If you specify more than one ACL, then the route can match any of the ACLs.

- To match the route type, enter the following command:

```
hostname(config-route-map)# match route-type {internal | external [type-1 | type-2]}
```

**Step 3** Enter one or more **set** commands.

If a route matches the **match** commands, then the following **set** commands determine the action to perform on the route before redistributing it.

- To set the metric, enter the following command:

```
hostname(config-route-map)# set metric metric_value
```

The *metric\_value* can be a value between 0 and 294967295

- To set the metric type, enter the following command:

```
hostname(config-route-map)# set metric-type {type-1 | type-2}
```

The following example shows how to redistribute routes with a hop count equal to 1. The security appliance redistributes these routes as external LSAs with a metric of 5, metric type of Type 1.

```
hostname(config)# route-map 1-to-2 permit
hostname(config-route-map)# match metric 1
hostname(config-route-map)# set metric 5
hostname(config-route-map)# set metric-type type-1
```

## Redistributing Static, Connected, or OSPF Routes to an OSPF Process

To redistribute static, connected, or OSPF routes from one process into another OSPF process, perform the following steps:

- Step 1** If you have not already done so, enter the router configuration mode for the OSPF process you want to redistribute into by entering the following command:

```
hostname(config)# router ospf process_id
```

- Step 2** To specify the routes you want to redistribute, enter the following command:

```
hostname(config-router)# redistribute {ospf process_id
[match {internal | external 1 | external 2}] | static | connect} [metric metric-value]
[metric-type {type-1 | type-2}] [tag tag_value] [subnets] [route-map map_name]
```

The **ospf process\_id**, **static**, and **connect** keywords specify from where you want to redistribute routes.

You can either use the options in this command to match and set route properties, or you can use a route map. The **tag** and **subnets** options do not have equivalents in the **route-map** command. If you use both a route map and options in the **redistribute** command, then they must match.

The following example shows route redistribution from OSPF process 1 into OSPF process 2 by matching routes with a metric equal to 1. The security appliance redistributes these routes as external LSAs with a metric of 5, metric type of Type 1, and a tag equal to 1.

```
hostname(config)# route-map 1-to-2 permit
hostname(config-route-map)# match metric 1
hostname(config-route-map)# set metric 5
hostname(config-route-map)# set metric-type type-1
hostname(config-route-map)# set tag 1
hostname(config-route-map)# router ospf 2
hostname(config-router)# redistribute ospf 1 route-map 1-to-2
```

The following example shows the specified OSPF process routes being redistributed into OSPF process 109. The OSPF metric is remapped to 100.

```
hostname(config)# router ospf 109
hostname(config-router)# redistribute ospf 108 metric 100 subnets
```

The following example shows route redistribution where the link-state cost is specified as 5 and the metric type is set to external, indicating that it has lower priority than internal metrics.

```
hostname(config)# router ospf 1
hostname(config-router)# redistribute ospf 2 metric 5 metric-type external
```

## Configuring OSPF Interface Parameters

You can alter some interface-specific OSPF parameters as necessary. You are not required to alter any of these parameters, but the following interface parameters must be consistent across all routers in an attached network: **ospf hello-interval**, **ospf dead-interval**, and **ospf authentication-key**. Be sure that if you configure any of these parameters, the configurations for all routers on your network have compatible values.

To configure OSPF interface parameters, perform the following steps:

**Step 1** To enter the interface configuration mode, enter the following command:

```
hostname(config)# interface interface_name
```

**Step 2** Enter any of the following commands:

- To specify the authentication type for an interface, enter the following command:

```
hostname(config-interface)# ospf authentication [message-digest | null]
```

- To assign a password to be used by neighboring OSPF routers on a network segment that is using the OSPF simple password authentication, enter the following command:

```
hostname(config-interface)# ospf authentication-key key
```

The *key* can be any continuous string of characters up to 8 bytes in length.

The password created by this command is used as a key that is inserted directly into the OSPF header when the security appliance software originates routing protocol packets. A separate password can be assigned to each network on a per-interface basis. All neighboring routers on the same network must have the same password to be able to exchange OSPF information.

- To explicitly specify the cost of sending a packet on an OSPF interface, enter the following command:

```
hostname(config-interface)# ospf cost cost
```

The *cost* is an integer from 1 to 65535.

- To set the number of seconds that a device must wait before it declares a neighbor OSPF router down because it has not received a hello packet, enter the following command:

```
hostname(config-interface)# ospf dead-interval seconds
```

The value must be the same for all nodes on the network.

- To specify the length of time between the hello packets that the security appliance sends on an OSPF interface, enter the following command:

```
hostname(config-interface)# ospf hello-interval seconds
```

The value must be the same for all nodes on the network.

- To enable OSPF MD5 authentication, enter the following command:

```
hostname(config-interface)# ospf message-digest-key key_id md5 key
```

Set the following values:

- *key\_id*—An identifier in the range from 1 to 255.
- *key*—Alphanumeric password of up to 16 bytes.

Usually, one key per interface is used to generate authentication information when sending packets and to authenticate incoming packets. The same key identifier on the neighbor router must have the same key value.

We recommend that you not keep more than one key per interface. Every time you add a new key, you should remove the old key to prevent the local system from continuing to communicate with a hostile system that knows the old key. Removing the old key also reduces overhead during rollover.

- To set the priority to help determine the OSPF designated router for a network, enter the following command:

```
hostname(config-interface)# ospf priority number_value
```

The *number\_value* is between 0 to 255.

- To specify the number of seconds between LSA retransmissions for adjacencies belonging to an OSPF interface, enter the following command:

```
hostname(config-interface)# ospf retransmit-interval seconds
```

The *seconds* must be greater than the expected round-trip delay between any two routers on the attached network. The range is from 1 to 65535 seconds. The default is 5 seconds.

- To set the estimated number of seconds required to send a link-state update packet on an OSPF interface, enter the following command:

```
hostname(config-interface)# ospf transmit-delay seconds
```

The *seconds* is from 1 to 65535 seconds. The default is 1 second.

The following example shows how to configure the OSPF interfaces:

```
hostname(config)# router ospf 2
hostname(config-router)# network 2.0.0.0 255.0.0.0 area 0
hostname(config-router)# interface inside
hostname(config-interface)# ospf cost 20
hostname(config-interface)# ospf retransmit-interval 15
hostname(config-interface)# ospf transmit-delay 10
hostname(config-interface)# ospf priority 20
hostname(config-interface)# ospf hello-interval 10
hostname(config-interface)# ospf dead-interval 40
hostname(config-interface)# ospf authentication-key cisco
hostname(config-interface)# ospf message-digest-key 1 md5 cisco
hostname(config-interface)# ospf authentication message-digest
```

The following is sample output from the **show ospf** command:

```
hostname(config)# show ospf

Routing Process "ospf 2" with ID 20.1.89.2 and Domain ID 0.0.0.2
Supports only single TOS(TOS0) routes
Supports opaque LSA
SPF schedule delay 5 secs, Hold time between two SPFs 10 secs
Minimum LSA interval 5 secs. Minimum LSA arrival 1 secs
Number of external LSA 5. Checksum Sum 0x 26da6
Number of opaque AS LSA 0. Checksum Sum 0x 0
Number of DCbitless external and opaque AS LSA 0
Number of DoNotAge external and opaque AS LSA 0
Number of areas in this router is 1. 1 normal 0 stub 0 nssa
External flood list length 0
 Area BACKBONE(0)
 Number of interfaces in this area is 1
 Area has no authentication
```



```

SPF algorithm executed 2 times
Area ranges are
Number of LSA 5. Checksum Sum 0x 209a3
Number of opaque link LSA 0. Checksum Sum 0x 0
Number of DCbitless LSA 0
Number of indication LSA 0
Number of DoNotAge LSA 0
Flood list length 0

```

## Configuring OSPF Area Parameters

You can configure several area parameters. These area parameters (shown in the following task table) include setting authentication, defining stub areas, and assigning specific costs to the default summary route. Authentication provides password-based protection against unauthorized access to an area.

Stub areas are areas into which information on external routes is not sent. Instead, there is a default external route generated by the ABR, into the stub area for destinations outside the autonomous system. To take advantage of the OSPF stub area support, default routing must be used in the stub area. To further reduce the number of LSAs sent into a stub area, you can configure the **no-summary** keyword of the **area stub** command on the ABR to prevent it from sending summary link advertisement (LSA type 3) into the stub area.

To specify area parameters for your network, perform the following steps:

---

**Step 1** If you have not already done so, enter the router configuration mode for the OSPF process you want to configure by entering the following command:

```
hostname(config)# router ospf process_id
```

**Step 2** Enter any of the following commands:

- To enable authentication for an OSPF area, enter the following command:

```
hostname(config-router)# area area-id authentication
```

- To enable MD5 authentication for an OSPF area, enter the following command:

```
hostname(config-router)# area area-id authentication message-digest
```

- To define an area to be a stub area, enter the following command:

```
hostname(config-router)# area area-id stub [no-summary]
```

- To assign a specific cost to the default summary route used for the stub area, enter the following command:

```
hostname(config-router)# area area-id default-cost cost
```

The *cost* is an integer from 1 to 65535. The default is 1.

---

The following example shows how to configure the OSPF area parameters:

```

hostname(config)# router ospf 2
hostname(config-router)# area 0 authentication
hostname(config-router)# area 0 authentication message-digest
hostname(config-router)# area 17 stub
hostname(config-router)# area 17 default-cost 20

```

## Configuring OSPF NSSA

The OSPF implementation of an NSSA is similar to an OSPF stub area. NSSA does not flood type 5 external LSAs from the core into the area, but it can import autonomous system external routes in a limited way within the area.

NSSA imports type 7 autonomous system external routes within an NSSA area by redistribution. These type 7 LSAs are translated into type 5 LSAs by NSSA ABRs, which are flooded throughout the whole routing domain. Summarization and filtering are supported during the translation.

You can simplify administration if you are an ISP or a network administrator that must connect a central site using OSPF to a remote site that is using a different routing protocol using NSSA.

Before the implementation of NSSA, the connection between the corporate site border router and the remote router could not be run as an OSPF stub area because routes for the remote site could not be redistributed into the stub area, and two routing protocols needed to be maintained. A simple protocol such as RIP was usually run and handled the redistribution. With NSSA, you can extend OSPF to cover the remote connection by defining the area between the corporate router and the remote router as an NSSA.

To specify area parameters for your network as needed to configure OSPF NSSA, perform the following steps:

---

**Step 1** If you have not already done so, enter the router configuration mode for the OSPF process you want to configure by entering the following command:

```
hostname(config)# router ospf process_id
```

**Step 2** Enter any of the following commands:

- To define an NSSA area, enter the following command:

```
hostname(config-router)# area area-id nssa [no-redistribution]
[default-information-originate]
```

- To summarize groups of addresses, enter the following command:

```
hostname(config-router)# summary address ip_address mask [not-advertise] [tag tag]
```

This command helps reduce the size of the routing table. Using this command for OSPF causes an OSPF ASBR to advertise one external route as an aggregate for all redistributed routes that are covered by the address.

OSPF does not support **summary-address 0.0.0.0 0.0.0.0**.

In the following example, the summary address 10.1.0.0 includes address 10.1.1.0, 10.1.2.0, 10.1.3.0, and so on. Only the address 10.1.0.0 is advertised in an external link-state advertisement:

```
hostname(config-router)# summary-address 10.1.1.0 255.255.0.0
```

Before you use this feature, consider these guidelines:

- You can set a type 7 default route that can be used to reach external destinations. When configured, the router generates a type 7 default into the NSSA or the NSSA area boundary router.
  - Every router within the same area must agree that the area is NSSA; otherwise, the routers will not be able to communicate.
-

## Configuring Route Summarization Between OSPF Areas

Route summarization is the consolidation of advertised addresses. This feature causes a single summary route to be advertised to other areas by an area boundary router. In OSPF, an area boundary router advertises networks in one area into another area. If the network numbers in an area are assigned in a way such that they are contiguous, you can configure the area boundary router to advertise a summary route that covers all the individual networks within the area that fall into the specified range.

To define an address range for route summarization, perform the following steps:

- Step 1** If you have not already done so, enter the router configuration mode for the OSPF process you want to configure by entering the following command:

```
hostname(config)# router ospf process_id
```

- Step 2** To set the address range, enter the following command:

```
hostname(config-router)# area area-id range ip-address mask [advertise | not-advertise]
```

The following example shows how to configure route summarization between OSPF areas:

```
hostname(config)# router ospf 1
hostname(config-router)# area 17 range 12.1.0.0 255.255.0.0
```

## Configuring Route Summarization When Redistributing Routes into OSPF

When routes from other protocols are redistributed into OSPF, each route is advertised individually in an external LSA. However, you can configure the security appliance to advertise a single route for all the redistributed routes that are covered by a specified network address and mask. This configuration decreases the size of the OSPF link-state database.

To configure the software advertisement on one summary route for all redistributed routes covered by a network address and mask, perform the following steps:

- Step 1** If you have not already done so, enter the router configuration mode for the OSPF process you want to configure by entering the following command:

```
hostname(config)# router ospf process_id
```

- Step 2** To set the summary address, enter the following command:

```
hostname(config-router)# summary-address ip_address mask [not-advertise] [tag tag]
```

OSPF does not support **summary-address 0.0.0.0 0.0.0.0**.

The following example shows how to configure route summarization. The summary address 10.1.0.0 includes address 10.1.1.0, 10.1.2.0, 10.1.3.0, and so on. Only the address 10.1.0.0 is advertised in an external link-state advertisement:

```
hostname(config)# router ospf 1
hostname(config-router)# summary-address 10.1.0.0 255.255.0.0
```

## Generating a Default Route

You can force an autonomous system boundary router to generate a default route into an OSPF routing domain. Whenever you specifically configure redistribution of routes into an OSPF routing domain, the router automatically becomes an autonomous system boundary router. However, an autonomous system boundary router does not by default generate a default route into the OSPF routing domain.

To generate a default route, perform the following steps:

- 
- Step 1** If you have not already done so, enter the router configuration mode for the OSPF process you want to configure by entering the following command:

```
hostname(config)# router ospf process_id
```

- Step 2** To force the autonomous system boundary router to generate a default route, enter the following command:

```
hostname(config-router)# default-information originate [always] [metric metric-value]
[metric-type {1 | 2}] [route-map map-name]
```

---

The following example shows how to generate a default route:

```
hostname(config)# router ospf 2
hostname(config-router)# default-information originate always
```

## Configuring Route Calculation Timers

You can configure the delay time between when OSPF receives a topology change and when it starts an SPF calculation. You also can configure the hold time between two consecutive SPF calculations.

To configure route calculation timers, perform the following steps:

- 
- Step 1** If you have not already done so, enter the router configuration mode for the OSPF process you want to configure by entering the following command:

```
hostname(config)# router ospf process_id
```

- Step 2** To configure the route calculation time, enter the following command:

```
hostname(config-router)# timers spf spf-delay spf-holdtime
```

The *spf-delay* is the delay time (in seconds) between when OSPF receives a topology change and when it starts an SPF calculation. It can be an integer from 0 to 65535. The default time is 5 seconds. A value of 0 means that there is no delay; that is, the SPF calculation is started immediately.

The *spf-holdtime* is the minimum time (in seconds) between two consecutive SPF calculations. It can be an integer from 0 to 65535. The default time is 10 seconds. A value of 0 means that there is no delay; that is, two SPF calculations can be done, one immediately after the other.

---

The following example shows how to configure route calculation timers:

```
hostname(config)# router ospf 1
hostname(config-router)# timers spf 10 120
```

## Logging Neighbors Going Up or Down

By default, the system sends a system message when an OSPF neighbor goes up or down.

Configure this command if you want to know about OSPF neighbors going up or down without turning on the **debug ospf adjacency** command. The **log-adj-changes** router configuration command provides a higher level view of the peer relationship with less output. Configure **log-adj-changes detail** if you want to see messages for each state change.

To log neighbors going up or down, perform the following steps:

**Step 1** If you have not already done so, enter the router configuration mode for the OSPF process you want to configure by entering the following command:

```
hostname(config)# router ospf process_id
```

**Step 2** To configure logging for neighbors going up or down, enter the following command:

```
hostname(config-router)# log-adj-changes [detail]
```



**Note** Logging must be enabled for the the neighbor up/down messages to be sent.

The following example shows how to log neighbors up/down messages:

```
hostname(config)# router ospf 1
hostname(config-router)# log-adj-changes detail
```

## Displaying OSPF Update Packet Pacing

OSPF update packets are automatically paced so they are not sent less than 33 milliseconds apart. Without pacing, some update packets could get lost in situations where the link is slow, a neighbor could not receive the updates quickly enough, or the router could run out of buffer space. For example, without pacing packets might be dropped if either of the following topologies exist:

- A fast router is connected to a slower router over a point-to-point link.
- During flooding, several neighbors send updates to a single router at the same time.

Pacing is also used between resends to increase efficiency and minimize lost retransmissions. You also can display the LSAs waiting to be sent out an interface. The benefit of the pacing is that OSPF update and retransmission packets are sent more efficiently.

There are no configuration tasks for this feature; it occurs automatically.

To observe OSPF packet pacing by displaying a list of LSAs waiting to be flooded over a specified interface, enter the following command:

```
hostname# show ospf flood-list if_name
```

## Monitoring OSPF

You can display specific statistics such as the contents of IP routing tables, caches, and databases. You can use the information provided to determine resource utilization and solve network problems. You can also display information about node reachability and discover the routing path that your device packets are taking through the network.

To display various routing statistics, perform one of the following tasks, as needed:

- To display general information about OSPF routing processes, enter the following command:

```
hostname# show ospf [process-id [area-id]]
```

- To display the internal OSPF routing table entries to the ABR and ASBR, enter the following command:

```
hostname# show ospf border-routers
```

- To display lists of information related to the OSPF database for a specific router, enter the following command:

```
hostname# show ospf [process-id [area-id]] database
```

- To display a list of LSAs waiting to be flooded over an interface (to observe OSPF packet pacing), enter the following command:

```
hostname# show ospf flood-list if-name
```

- To display OSPF-related interface information, enter the following command:

```
hostname# show ospf interface [if_name]
```

- To display OSPF neighbor information on a per-interface basis, enter the following command:

```
hostname# show ospf neighbor [interface-name] [neighbor-id] [detail]
```

- To display a list of all LSAs requested by a router, enter the following command:

```
hostname# show ospf request-list neighbor if_name
```

- To display a list of all LSAs waiting to be resent, enter the following command:

```
hostname# show ospf retransmission-list neighbor if_name
```

- To display a list of all summary address redistribution information configured under an OSPF process, enter the following command:

```
hostname# show ospf [process-id] summary-address
```

- To display OSPF-related virtual links information, enter the following command:

```
hostname# show ospf [process-id] virtual-links
```

## Restarting the OSPF Process

To restart an OSPF process, clear redistribution, or counters, enter the following command:

```
hostname(config)# clear ospf pid {process | redistribution | counters
[neighbor [neighbor-interface] [neighbor-id]]}
```

# Configuring RIP

This section describes how to configure RIP. This section includes the following topics:

- [RIP Overview, page 8-17](#)
- [Enabling RIP, page 8-17](#)

## RIP Overview

Devices that support RIP send routing-update messages at regular intervals and when the network topology changes. These RIP packets contain information about the networks that the devices can reach, as well as the number of routers or gateways that a packet must travel through to reach the destination address. RIP generates more traffic than OSPF, but is easier to configure initially.

RIP has advantages over static routes because the initial configuration is simple, and you do not need to update the configuration when the topology changes. The disadvantage to RIP is that there is more network and processing overhead than static routing.

The security appliance uses a limited version of RIP; it does not send out RIP updates that identify the networks that the security appliance can reach. However, you can enable one or both of the following methods:

- **Passive RIP**—The security appliance listens for RIP updates but does not send any updates about its networks out of the interface.

Passive RIP allows the security appliance to learn about networks to which it is not directly connected.

- **Default Route Updates**—Instead of sending normal RIP updates that describe all the networks reachable through the security appliance, the security appliance sends a default route to participating devices that identifies the security appliance as the default gateway.

You can use the default route option with passive RIP, or alone. You might use the default route option alone if you use static routes on the security appliance, but do not want to configure static routes on downstream routers. Typically, you would not enable the default route option on the outside interface, because the security appliance is not typically the default gateway for the upstream router.

## Enabling RIP

To enable RIP on an interface, enter the following command:

```
hostname(config)# rip interface_name {default | passive} [version {1 | 2}
[authentication {text | md5} key key_id]]
```

You can enable both the passive and default modes of RIP on an interface by entering the **rip** command twice, one time for each method. For example, enter the following commands:

```
hostname(config)# rip inside default version 2 authentication md5 scorpius 1
hostname(config)# rip inside passive version 2 authentication md5 scorpius 1
```

If you want to enable passive RIP on all interfaces, but only enable default routes on the inside interface, enter the following commands:

```
hostname(config)# rip inside default version 2 authentication md5 scorpius 1
hostname(config)# rip inside passive version 2 authentication md5 scorpius 1
hostname(config)# rip outside passive version 2 authentication md5 scorpius 1
```

**Note**

Before testing your configuration, flush the ARP caches on any routers connected to the security appliance. For Cisco routers, use the **clear arp** command to flush the ARP cache.

You cannot enable RIP if OSPF is enabled.

## Dynamic Routing and Failover

Dynamic routes are not replicated to the standby unit or failover group in a failover configuration. Therefore, immediately after a failover occurs, some packets received by the security appliance may be dropped because of a lack of routing information or routed to a default static route while the routing table is repopulated by the configured dynamic routing protocols.

## Configuring Multicast Routing

This section describes how to configure multicast routing. This section includes the following topics:

- [Multicast Routing Overview, page 8-18](#)
- [Enabling Multicast Routing, page 8-19](#)
- [Configuring IGMP Features, page 8-19](#)
- [Configuring Stub Multicast Routing, page 8-22](#)
- [Configuring a Static Multicast Route, page 8-22](#)
- [Configuring PIM Features, page 8-23](#)
- [For More Information about Multicast Routing, page 8-25](#)

## Multicast Routing Overview

The security appliance supports both stub multicast routing and PIM multicast routing. However, you cannot configure both concurrently on a single security appliance.

Stub multicast routing provides dynamic host registration and facilitates multicast routing. When configured for stub multicast routing, the security appliance acts as an IGMP proxy agent. Instead of fully participating in multicast routing, the security appliance forwards IGMP messages to an upstream multicast router, which sets up delivery of the multicast data. When configured for stub multicast routing, the security appliance cannot be configured for PIM.

The security appliance supports both PIM-SM and bi-directional PIM. PIM-SM is a multicast routing protocol that uses the underlying unicast routing information base or a separate multicast-capable routing information base. It builds unidirectional shared trees rooted at a single Rendezvous Point per multicast group and optionally creates shortest-path trees per multicast source.

Bi-directional PIM is a variant of PIM-SM that builds bi-directional shared trees connecting multicast sources and receivers. Bi-directional trees are built using a DF election process operating on each link of the multicast topology. With the assistance of the DF, multicast data is forwarded from sources to the Rendezvous Point, and therefore along the shared tree to receivers, without requiring source-specific state. The DF election takes place during Rendezvous Point discovery and provides a default route to the Rendezvous Point.



**Note**

If the security appliance is the PIM RP, use the untranslated outside address of the security appliance as the RP address.

## Enabling Multicast Routing

Enabling multicast routing lets the security appliance forward multicast packets. Enabling multicast routing automatically enables PIM and IGMP on all interfaces. To enable multicast routing, enter the following command:

```
hostname(config)# multicast-routing
```

The number of entries in the multicast routing tables are limited by the amount of RAM on the system. [Table 8-1](#) lists the maximum number of entries for specific multicast tables based on the amount of RAM on the security appliance. Once these limits are reached, any new entries are discarded.

**Table 8-1** *Entry Limits for Multicast Tables*

| Table              | 16 MB | 128 MB | 128+ MB |
|--------------------|-------|--------|---------|
| <b>MFIB</b>        | 1000  | 3000   | 5000    |
| <b>IGMP Groups</b> | 1000  | 3000   | 5000    |
| <b>PIM Routes</b>  | 3000  | 7000   | 12000   |

## Configuring IGMP Features

IP hosts use IGMP to report their group memberships to directly connected multicast routers. IGMP uses group addresses (Class D IP address) as group identifiers. Host group address can be in the range 224.0.0.0 to 239.255.255.255. The address 224.0.0.0 is never assigned to any group. The address 224.0.0.1 is assigned to all systems on a subnet. The address 224.0.0.2 is assigned to all routers on a subnet.

When you enable multicast routing on the security appliance, IGMP Version 2 is automatically enabled on all interfaces.

**Note**

Only the **no igmp** command appears in the interface configuration when you use the **show run** command. If the **multicast-routing** command appears in the device configuration, then IGMP is automatically enabled on all interfaces.

This section describes how to configure optional IGMP setting on a per-interface basis. This section includes the following topics:

- [Disabling IGMP on an Interface, page 8-20](#)
- [Configuring Group Membership, page 8-20](#)
- [Configuring a Statically Joined Group, page 8-20](#)
- [Controlling Access to Multicast Groups, page 8-20](#)
- [Limiting the Number of IGMP States on an Interface, page 8-21](#)
- [Modifying the Query Interval and Query Timeout, page 8-21](#)

- [Changing the Query Response Time, page 8-22](#)
- [Changing the IGMP Version, page 8-22](#)

## Disabling IGMP on an Interface

You can disable IGMP on specific interfaces. This is useful if you know that you do not have any multicast hosts on a specific interface and you want to prevent the security appliance from sending host query messages on that interface.

To disable IGMP on an interface, enter the following command:

```
hostname(config-if)# no igmp
```

To reenable IGMP on an interface, enter the following command:

```
hostname(config-if)# igmp
```



### Note

Only the **no igmp** command appears in the interface configuration.

## Configuring Group Membership

You can configure the security appliance to be a member of a multicast group. Configuring the security appliance to join a multicast group causes upstream routers to maintain multicast routing table information for that group and keep the paths for that group active.

To have the security appliance join a multicast group, enter the following command:

```
hostname(config-if)# igmp join-group group-address
```

## Configuring a Statically Joined Group

Sometimes a group member cannot report its membership in the group, or there may be no members of a group on the network segment, but you still want multicast traffic for that group to be sent to that network segment. You can have multicast traffic for that group sent to the segment in one of two ways:

- Using the **igmp join-group** command (see [Configuring Group Membership, page 8-20](#)). This causes the security appliance to accept and to forward the multicast packets.
- Using the **igmp static-group** command. The security appliance does not accept the multicast packets but rather forwards them to the specified interface.

To configure a statically joined multicast group on an interface, enter the following command:

```
hostname(config-if)# igmp static-group group-address
```

## Controlling Access to Multicast Groups

To control the multicast groups that hosts on the security appliance interface can join, perform the following steps:

- 
- Step 1** Create an access list for the multicast traffic. You can create more than one entry for a single access list. You can use extended or standard access lists.

- To create a standard access list, enter the following command:

```
hostname(config)# access-list name standard [permit | deny] ip_addr mask
```

The *ip\_addr* argument is the IP address of the multicast group being permitted or denied.

- To create an extended access list, enter the following command:

```
hostname(config)# access-list name extended [permit | deny] protocol src_ip_addr
src_mask dst_ip_addr dst_mask
```

The *dst\_ip\_addr* argument is the IP address of the multicast group being permitted or denied.

**Step 2** Apply the access list to an interface by entering the following command:

```
hostname(config-if)# igmp access-group acl
```

The *acl* argument is the name of a standard or extended IP access list.

---

## Limiting the Number of IGMP States on an Interface

You can limit the number of IGMP states resulting from IGMP membership reports on a per-interface basis. Membership reports exceeding the configured limits are not entered in the IGMP cache and traffic for the excess membership reports is not forwarded.

To limit the number of IGMP states on an interface, enter the following command:

```
hostname(config-if)# igmp limit number
```

Valid values range from 0 to 500, with 500 being the default value. Setting this value to 0 prevents learned groups from being added, but manually defined memberships (using the **igmp join-group** and **igmp static-group** commands) are still permitted. The **no** form of this command restores the default value.

## Modifying the Query Interval and Query Timeout

The security appliance sends query messages to discover which multicast groups have members on the networks attached to the interfaces. Members respond with IGMP report messages indicating that they want to receive multicast packets for specific groups. Query messages are addressed to the all-systems multicast group, which has an address of 224.0.0.1, with a time-to-live value of 1.

These messages are sent periodically to refresh the membership information stored on the security appliance. If the security appliance discovers that there are no local members of a multicast group still attached to an interface, it stops forwarding multicast packet for that group to the attached network and it sends a prune message back to the source of the packets.

By default, the PIM designated router on the subnet is responsible for sending the query messages. By default, they are sent once every 125 seconds. To change this interval, enter the following command:

```
hostname(config-if)# igmp query-interval seconds
```

If the security appliance does not hear a query message on an interface for the specified timeout value (by default, 255 seconds), then the security appliance becomes the designated router and starts sending the query messages. To change this timeout value, enter the following command:

```
hostname(config-if)# igmp query-timeout seconds
```

**Note**

---

The **igmp query-timeout** and **igmp query-interval** commands require IGMP Version 2.

---

## Changing the Query Response Time

By default, the maximum query response time advertised in IGMP queries is 10 seconds. If the security appliance does not receive a response to a host query within this amount of time, it deletes the group.

To change the maximum query response time, enter the following command:

```
hostname(config-if)# igmp query-max-response-time seconds
```

## Changing the IGMP Version

By default, the security appliance runs IGMP Version 2, which enables several additional features such as the **igmp query-timeout** and **igmp query-interval** commands.

All multicast routers on a subnet must support the same version of IGMP. The security appliance does not automatically detect version 1 routers and switch to version 1. However, a mix of IGMP Version 1 and 2 hosts on the subnet works; the security appliance running IGMP Version 2 works correctly when IGMP Version 1 hosts are present.

To control which version of IGMP is running on an interface, enter the following command:

```
hostname(config-if)# igmp version {1 | 2}
```

## Configuring Stub Multicast Routing

A security appliance acting as the gateway to the stub area does not need to participate in PIM. Instead, you can configure it to act as an IGMP proxy agent and forward IGMP messages from hosts connected on one interface to an upstream multicast router on another. To configure the security appliance as an IGMP proxy agent, forward the host join and leave messages from the stub area interface to an upstream interface.

To forward the host join and leave messages, enter the following command from the interface attached to the stub area:

```
hostname(config-if)# igmp forward interface if_name
```

**Note**

---

Stub Multicast Routing and PIM are not supported concurrently.

---

## Configuring a Static Multicast Route

When using PIM, the security appliance expects to receive packets on the same interface where it sends unicast packets back to the source. In some cases, such as bypassing a route that does not support multicast routing, you may want unicast packets to take one path and multicast packets to take another.

Static multicast routes are not advertised or redistributed.

To configure a static multicast route for PIM, enter the following command:

```
hostname(config)# mroute src_ip src_mask input_if_name [distance]
```

To configure a static multicast route for a stub area, enter the following command:

```
hostname(config)# mroute src_ip src_mask input_if_name [dense output_if_name] [distance]
```

**Note**

The **dense output\_if\_name** keyword and argument pair is only supported for stub multicast routing.

## Configuring PIM Features

Routers use PIM to maintain forwarding tables for forwarding multicast diagrams. When you enable multicast routing on the security appliance, PIM and IGMP are automatically enabled on all interfaces.

**Note**

PIM is not supported with PAT. The PIM protocol does not use ports and PAT only works with protocols that use ports.

This section describes how to configure optional PIM settings. This section includes the following topics:

- [Disabling PIM on an Interface, page 8-23](#)
- [Configuring a Static Rendezvous Point Address, page 8-23](#)
- [Configuring the Designated Router Priority, page 8-24](#)
- [Filtering PIM Register Messages, page 8-24](#)
- [Configuring PIM Message Intervals, page 8-24](#)

## Disabling PIM on an Interface

You can disable PIM on specific interfaces. To disable PIM on an interface, enter the following command:

```
hostname(config-if)# no pim
```

To reenable PIM on an interface, enter the following command:

```
hostname(config-if)# pim
```

**Note**

Only the **no pim** command appears in the interface configuration.

## Configuring a Static Rendezvous Point Address

All routers within a common PIM sparse mode or bidir domain require knowledge of the PIM RP address. The address is statically configured using the **pim rp-address** command.

**Note**

The security appliance does not support Auto-RP or PIM BSR; you must use the **pim rp-address** command to specify the RP address.

You can configure the security appliance to serve as RP to more than one group. The group range specified in the access list determines the PIM RP group mapping. If an access list is not specified, then the RP for the group is applied to the entire multicast group range (224.0.0.0/4).

To configure the address of the PIM RP, enter the following command:

```
hostname(config)# pim rp-address ip_address [acl] [bidir]
```

The *ip\_address* argument is the unicast IP address of the router to be a PIM RP. The *acl* argument is the name or number of a standard access list that defines which multicast groups the RP should be used with. Do not use a host ACL with this command. Excluding the **bidir** keyword causes the groups to operate in PIM sparse mode.

**Note**

---

The security appliance always advertises the bidir capability in the PIM hello messages regardless of the actual bidir configuration.

---

## Configuring the Designated Router Priority

The DR is responsible for sending PIM register, join, and prune messages to the RP. When there is more than one multicast router on a network segment, there is an election process to select the DR based on DR priority. If multiple devices have the same DR priority, then the device with the highest IP address becomes the DR.

By default, the security appliance has a DR priority of 1. You can change this value by entering the following command:

```
hostname(config-if)# pim dr-priority num
```

The *num* argument can be any number from 1 to 4294967294.

## Filtering PIM Register Messages

You can configure the security appliance to filter PIM register messages. To filter PIM register messages, enter the following command:

```
hostname(config)# pim accept-register {list acl | route-map map-name}
```

## Configuring PIM Message Intervals

Router query messages are used to elect the PIM DR. The PIM DR is responsible for sending router query messages. By default, router query messages are sent every 30 seconds. You can change this value by entering the following command:

```
hostname(config-if)# pim hello-interval seconds
```

Valid values for the *seconds* argument range from 1 to 3600 seconds.

Every 60 seconds, the security appliance sends PIM join/prune messages. To change this value, enter the following command:

```
hostname(config-if)# pim join-prune-interval seconds
```

Valid values for the *seconds* argument range from 10 to 600 seconds.

## For More Information about Multicast Routing

The following RFCs from the IETF provide technical details about the IGMP and multicast routing standards used for implementing the SMR feature:

- RFC 2236 IGMPv2
- RFC 2362 PIM-SM
- RFC 2588 IP Multicast and Firewalls
- RFC 2113 IP Router Alert Option
- IETF draft-ietf-idmr-igmp-proxy-01.txt

## Configuring DHCP

DHCP provides network configuration parameters, such as IP addresses, to DHCP clients. The security appliance can provide a DHCP server or DHCP relay services to DHCP clients attached to security appliance interfaces. The DHCP server provides network configuration parameters directly to DHCP clients. DHCP relay passes DHCP requests received on one interface to an external DHCP server located behind a different interface.

This section includes the following topics:

- [Configuring a DHCP Server, page 8-25](#)
- [Configuring DHCP Relay Services, page 8-28](#)

## Configuring a DHCP Server

This section describes how to configure DHCP server provided by the security appliance. This section includes the following topics:

- [Enabling the DHCP Server, page 8-25](#)
- [Configuring DHCP Options, page 8-27](#)
- [Using Cisco IP Phones with a DHCP Server, page 8-27](#)

## Enabling the DHCP Server

The security appliance can act as a DHCP server. DHCP is a protocol that supplies network settings to hosts including the host IP address, the default gateway, and a DNS server.

**Note**

The security appliance DHCP server does not support BOOTP requests.

In multiple context mode, you cannot enable the DHCP server or DHCP relay on an interface that is used by more than one context.

You can configure a DHCP server on each interface of the security appliance. Each interface can have its own pool of addresses to draw from. However the other DHCP settings, such as DNS servers, domain name, options, ping timeout, and WINS servers, are configured globally and used by the DHCP server on all interfaces.

You cannot configure a DHCP client or DHCP Relay services on an interface on which the server is enabled. Additionally, DHCP clients must be directly connected to the interface on which the server is enabled.

To enable the DHCP server on a given security appliance interface, perform the following steps:

- 
- Step 1** Create a DHCP address pool. Enter the following command to define the address pool:

```
hostname(config)# dhcpd address ip_address-ip_address interface_name
```

The security appliance assigns a client one of the addresses from this pool to use for a given length of time. These addresses are the local, untranslated addresses for the directly connected network.

The address pool must be on the same subnet as the security appliance interface.

- Step 2** (Optional) To specify the IP address(es) of the DNS server(s) the client will use, enter the following command:

```
hostname(config)# dhcpd dns dns1 [dns2]
```

You can specify up to two DNS servers.

- Step 3** (Optional) To specify the IP address(es) of the WINS server(s) the client will use, enter the following command:

```
hostname(config)# dhcpd wins wins1 [wins2]
```

You can specify up to two WINS servers.

- Step 4** (Optional) To change the lease length to be granted to the client, enter the following command:

```
hostname(config)# dhcpd lease lease_length
```

This lease equals the amount of time (in seconds) the client can use its allocated IP address before the lease expires. Enter a value between 300 to 1,048,575. The default value is 3600 seconds.

- Step 5** (Optional) To configure the domain name the client uses, enter the following command:

```
hostname(config)# dhcpd domain domain_name
```

- Step 6** (Optional) To configure the DHCP ping timeout value, enter the following command:

```
hostname(config)# dhcpd ping_timeout milliseconds
```

To avoid address conflicts, the security appliance sends two ICMP ping packets to an address before assigning that address to a DHCP client. This command specifies the timeout value for those packets.

- Step 7** (Transparent Firewall Mode) Define a default gateway. To define the default gateway that is sent to DHCP clients, enter the following command:

```
hostname(config)# dhcpd option 3 ip gateway_ip
```

If you do not use the DHCP option 3 to define the default gateway, DHCP clients use the IP address of the management interface. The management interface does not route traffic.

- Step 8** To enable the DHCP daemon within the security appliance to listen for DHCP client requests on the enabled interface, enter the following command:

```
hostname(config)# dhcpd enable interface_name
```

---



For example, to assign the range 10.0.1.101 to 10.0.1.110 to hosts connected to the inside interface, enter the following commands:

```
hostname(config)# dhcpd address 10.0.1.101-10.0.1.110 inside
hostname(config)# dhcpd dns 209.165.201.2 209.165.202.129
hostname(config)# dhcpd wins 209.165.201.5
hostname(config)# dhcpd lease 3000
hostname(config)# dhcpd domain example.com
hostname(config)# dhcpd enable inside
```

## Configuring DHCP Options

You can configure the security appliance to send information for the DHCP options listed in RFC 2132. The DHCP options fall into one of three categories:

- Options that return an IP address.
- Options that return a text string.
- Options that return a hexadecimal value.

The security appliance supports all three categories of DHCP options. To configure a DHCP option, do one of the following:

- To configure a DHCP option that returns one or two IP addresses, enter the following command:

```
hostname(config)# dhcpd option code ip addr_1 [addr_2]
```

- To configure a DHCP option that returns a text string, enter the following command:

```
hostname(config)# dhcpd option code ascii text
```

- To configure a DHCP option that returns a hexadecimal value, enter the following command:

```
hostname(config)# dhcpd option code hex value
```



### Note

The security appliance does not verify that the option type and value that you provide match the expected type and value for the option code as defined in RFC 2132. For example, you can enter `dhcpd option 46 ascii hello`, and the security appliance accepts the configuration although option 46 is defined in RFC 2132 as expecting a single-digit, hexadecimal value. For more information about the option codes and their associated types and expected values, refer to RFC 2132.

Specific options, DHCP option 3, 66, and 150, are used to configure Cisco IP Phones. See the [“Using Cisco IP Phones with a DHCP Server”](#) section on page 8-27 topic for more information about configuring those options.

## Using Cisco IP Phones with a DHCP Server

Enterprises with small branch offices that implement a Cisco IP Telephony Voice over IP solution typically implement Cisco CallManager at a central office to control Cisco IP Phones at small branch offices. This implementation allows centralized call processing, reduces the equipment required, and eliminates the administration of additional Cisco CallManager and other servers at branch offices.

Cisco IP Phones download their configuration from a TFTP server. When a Cisco IP Phone starts, if it does not have both the IP address and TFTP server IP address preconfigured, it sends a request with option 150 or 66 to the DHCP server to obtain this information.

- DHCP option 150 provides the IP addresses of a list of TFTP servers.
- DHCP option 66 gives the IP address or the hostname of a single TFTP server.

Cisco IP Phones might also include DHCP option 3 in their requests, which sets the default route.

Cisco IP Phones might include both option 150 and 66 in a single request. In this case, the security appliance DHCP server provides values for both options in the response if they are configured on the security appliance.

You can configure the security appliance to send information for most options listed in RFC 2132. The following table shows the syntax for any option number, as well as the syntax for commonly-used options 66, 150, and 3:

- To provide information for DHCP requests that include an option number as specified in RFC-2132, enter the following command:

```
hostname(config)# dhcpd option number value
```

- To provide the IP address or name of a TFTP server for option 66, enter the following command:

```
hostname(config)# dhcpd option 66 ascii server_name
```

- To provide the IP address or names of one or two TFTP servers for option 150, enter the following command:

```
hostname(config)# dhcpd option 150 ip server_ip1 [server_ip2]
```

The *server\_ip1* is the IP address or name of the primary TFTP server while *server\_ip2* is the IP address or name of the secondary TFTP server. A maximum of two TFTP servers can be identified using option 150.

- To provide set the default route, enter the following command:

```
hostname(config)# dhcpd option 3 ip router_ip1
```

## Configuring DHCP Relay Services

A DHCP relay agent allows the security appliance to forward DHCP requests from clients to a router connected to a different interface.

The following restrictions apply to the use of the DHCP relay agent:

- The relay agent cannot be enabled if the DHCP server feature is also enabled.
- Clients must be directly connected to the security appliance and cannot send requests through another relay agent or a router.
- For multiple context mode, you cannot enable DHCP relay on an interface that is used by more than one context.



### Note

DHCP Relay services are not available in transparent firewall mode. A security appliance in transparent firewall mode only allows ARP traffic through; all other traffic requires an ACL. To allow DHCP requests and replies through the security appliance in transparent mode, you need to configure two ACLs, one that allows DHCP requests from the inside interface to the outside, and one that allows the replies from the server in the other direction.

To enable DHCP relay, perform the following steps:

- Step 1** To set the IP address of a DHCP server on a different interface from the DHCP client, enter the following command:

```
hostname(config)# dhcprelay server ip_address if_name
```

You can use this command up to 4 times to identify up to 4 servers.

- Step 2** To enable DHCP relay on the interface connected to the clients, enter the following command:

```
hostname(config)# dhcprelay enable interface
```

- Step 3** (Optional) To set the number of seconds allowed for relay address negotiation, enter the following command:

```
hostname(config)# dhcprelay timeout seconds
```

- Step 4** (Optional) To change the first default router address in the packet sent from the DHCP server to the address of the security appliance interface, enter the following command:

```
hostname(config)# dhcprelay setroute interface_name
```

This action allows the client to set its default route to point to the security appliance even if the DHCP server specifies a different router.

If there is no default router option in the packet, the security appliance adds one containing the interface address.

The following example enables the security appliance to forward DHCP requests from clients connected to the inside interface to a DHCP server on the outside interface:

```
hostname(config)# dhcprelay server 201.168.200.4
hostname(config)# dhcprelay enable inside
hostname(config)# dhcprelay setroute inside
```

## Configuring the DHCP Client

To configure the security appliance interface as a DHCP client, perform the following steps:

```
hostname(config-if)# ip address dhcp [retry num] [setroute]
```

The optional **retry num** argument specifies the number of times the interface will attempt to contact a DHCP server. The default value is 4, the maximum value is 48. The **setroute** keyword causes the security appliance to set the default route using the default gateway the DHCP server returns.



### Note

You cannot enable a DHCP server or DHCP Relay services on an interface that is configured as a DHCP client.





## Configuring IPv6

---

This chapter describes how to enable and configure IPv6 on the security appliance. IPv6 is available in Routed firewall mode only.

This chapter includes the following sections:

- [IPv6-enabled Commands, page 9-1](#)
- [Configuring IPv6 on an Interface, page 9-2](#)
- [Configuring IPv6 Default and Static Routes, page 9-3](#)
- [Configuring IPv6 Access Lists, page 9-4](#)
- [Verifying the IPv6 Configuration, page 9-5](#)
- [Configuring a Dual IP Stack on an Interface, page 9-6](#)
- [IPv6 Configuration Example, page 9-7](#)

### IPv6-enabled Commands

The following security appliance commands can accept and display IPv6 addresses:

- capture
- configure
- copy
- http
- name
- object-group
- ping
- show conn
- show local-host
- show tcpstat
- ssh

- telnet
- tftp-server
- who
- write

When entering IPv6 addresses in commands that support them, simply enter the IPv6 address using standard IPv6 notation, for example `ping fe80::2e0:b6ff:fe01:3b7a`. The security appliance correctly recognizes and processes the IPv6 address. However, you must enclose the IPv6 address in square brackets ( [ ] ) in the following situations:

- You need to specify a port number with the address, for example `[fe80::2e0:b6ff:fe01:3b7a]:8080`.
- The command uses a colon as a separator, such as the **write net** and **config net** commands. For example, `configure net [fe80::2e0:b6ff:fe01:3b7a]:tftp/config/pixconfig`.

The following commands were modified to work for IPv6:

- debug
- fragment
- ip verify
- mtu
- icmp (entered as **ipv6 icmp**)

The following inspection engines support IPv6:

- FTP
- HTTP
- ICMP
- SMTP
- TCP
- UDP

## Configuring IPv6 on an Interface

At a minimum, each interface needs to be configured with an IPv6 link-local address. Additionally, you can add a site-local and global address to the interface.



### Note

The security appliance does not support IPv6 anycast addresses.

You can configure both IPv6 and IPv4 addresses on an interface.

To configure IPv6 on an interface, perform the following steps:

- 
- Step 1** Enter interface configuration mode for the interface for which you are configuring the IPv6 addresses:
- ```
hostname(config)# interface if
```
- Step 2** Configure an IPv6 address for the interface. You can assign several IPv6 addresses to an interface, such as an IPv6 link-local, site-local, and global address. However, at a minimum, you must configure a link-local address.

There are several methods for configuring IPv6 addresses for an interface. Pick the method that suits your needs from the following:

- The simplest method is to enable stateless autoconfiguration on the interface. Enabling stateless autoconfiguration on the interface configures IPv6 addresses based on prefixes received in Router Advertisement messages. A link-local address, based on the Modified EUI-64 interface ID, is automatically generated for the interface when stateless autoconfiguration is enabled. To enable stateless autoconfiguration, enter the following command:

```
hostname(config-if)# ipv6 address autoconfig
```

- If you only need to configure a link-local address on the interface and are not going to assign any other IPv6 addresses to the interface, you have the option of manually defining the link-local address or generating one based on the interface MAC address (Modified EUI-64 format).

Enter the following command to manually specify the link-local address:

```
hostname(config-if)# ipv6 address ipv6-address link-local
```

Enter the following command to enable IPv6 on the interface and automatically generate the link-local address using the Modified EUI-64 interface ID based on the interface MAC address:

```
hostname(config-if)# ipv6 enable
```



Note You do not need to use the **ipv6 enable** command if you enter any other **ipv6 address** commands on an interface; IPv6 support is automatically enabled as soon as you assign an IPv6 address to the interface.

- Assign a site-local or global address to the interface. When you assign a site-local or global address, a link-local address is automatically created. Enter the following command to add a global or site-local address to the interface. Use the optional **eui-64** keyword to use the Modified EUI-64 interface ID in the low order 64 bits of the address.

```
hostname(config-if)# ipv6 address ipv6-address [eui-64]
```

Step 3 (Optional) Suppress Router Advertisement messages on an interface. By default, Router Advertisement messages are automatically sent in response to router solicitation messages. You may want to disable these messages on any interface for which you do not want the security appliance to supply the IPv6 prefix (for example, the outside interface).

Enter the following command to suppress Router Advertisement messages on an interface:

```
hostname(config-if)# ipv6 nd suppress-ra
```

See the “[IPv6 Configuration Example](#)” section on page 9-7 for an example IPv6 addresses applied to an interface.

Configuring IPv6 Default and Static Routes

IPv6 unicast routing is always enabled. The security appliance routes IPv6 traffic between interfaces as long as the interfaces are enabled for IPv6 and the IPv6 ACLs allow the traffic. You can add a default route and static routes using the **ipv6 route** command.

To configure an IPv6 default route and static routes, perform the following steps:

Step 1 To add the default route, use the following command:

```
hostname(config)# ipv6 route interface_name ::/0 next_hop_ipv6_addr
```

The address `::/0` is the IPv6 equivalent of “any.”

Step 2 (Optional) Define IPv6 static routes. Use the following command to add an IPv6 static route to the IPv6 routing table:

```
hostname(config)# ipv6 route if_name destination next_hop_ipv6_addr [admin_distance]
```



Note

The `ipv6 route` command works like the `route` command used to define IPv4 static routes.

See the “[IPv6 Configuration Example](#)” section on page 9-7 for an example of the `ipv6 route` command used to configure the default route.

Configuring IPv6 Access Lists

Configuring an IPv6 access list is similar configuring an IPv4 access, but with IPv6 addresses.

To configure an IPv6 access list, perform the following steps:

Step 1 Create an access entry. To create an access list, use the `ipv6 access-list` command to create entries for the access list. There are two main forms of this command to choose from, one for creating access list entries specifically for ICMP traffic, and one to create access list entries for all other types of IP traffic.

- To create an IPv6 access list entry specifically for ICMP traffic, enter the following command:

```
hostname(config)# ipv6 access-list id [line num] {permit | deny} icmp source
destination [icmp_type]
```

- To create an IPv6 access list entry, enter the following command:

```
hostname(config)# ipv6 access-list id [line num] {permit | deny} protocol source
[src_port] destination [dst_port]
```

The following describes the arguments for the `ipv6 access-list` command:

- `id`—The name of the access list. Use the same `id` in each command when you are entering multiple entries for an access list.
- `line num`—When adding an entry to an access list, you can specify the line number in the list where the entry should appear.
- `permit | deny`—Determines whether the specified traffic is blocked or allowed to pass.
- `icmp`—Indicates that the access list entry applies to ICMP traffic.
- `protocol`—Specifies the traffic being controlled by the access list entry. This can be the name (`ip`, `tcp`, or `udp`) or number (1-254) of an IP protocol. Alternatively, you can specify a protocol object group using `object-group grp_id`.
- `source` and `destination`—Specifies the source or destination of the traffic. The source or destination can be an IPv6 prefix, in the format `prefix/length`, to indicate a range of addresses, the keyword `any`, to specify any address, or a specific host designated by `host host_ipv6_addr`.

- *src_port* and *dst_port*—The source and destination port (or service) argument. Enter an operator (**lt** for less than, **gt** for greater than, **eq** for equal to, **neq** for not equal to, or **range** for an inclusive range) followed by a space and a port number (or two port numbers separated by a space for the **range** keyword).
- *icmp_type*—Specifies the ICMP message type being filtered by the access rule. The value can be a valid ICMP type number (from 0 to 155) or one of the ICMP type literals as shown in [Appendix D, “Addresses, Protocols, and Ports”](#). Alternatively, you can specify an ICMP object group using **object-group id**.

Step 2 To apply the access list to an interface, enter the following command:

```
hostname(config)# access-group access_list_name {in | out} interface if_name
```

See the “[IPv6 Configuration Example](#)” section on [page 9-7](#) for an example IPv6 access list.

Verifying the IPv6 Configuration

This section describes how to verify your IPv6 configuration. You can use various show commands to verify your IPv6 settings.

This section includes the following topics:

- [The show ipv6 interface Command, page 9-5](#)
- [The show ipv6 route Command, page 9-6](#)

The show ipv6 interface Command

To display the IPv6 interface settings, enter the following command:

```
hostname# show ipv6 interface [if_name]
```

Including the interface name, such as “outside”, displays the settings for the specified interface. Excluding the name from the command displays the setting for all interfaces that have IPv6 enabled on them. The output for the command shows the following:

- The name and status of the interface.
- The link-local and global unicast addresses.
- The multicast groups the interface belongs to.
- ICMP redirect and error message settings.
- Neighbor discovery settings.

The following is sample output from the **show ipv6 interface** command:

```
hostname# show ipv6 interface

ipv6interface is down, line protocol is down
  IPv6 is enabled, link-local address is fe80::20d:88ff:feee:6a82 [TENTATIVE]
  No global unicast address is configured
  Joined group address(es):
    ff02::1
    ff02::1:ffee:6a82
  ICMP error messages limited to one every 100 milliseconds
```

```
ICMP redirects are enabled
ND DAD is enabled, number of DAD attempts: 1
ND reachable time is 30000 milliseconds
```

**Note**

The **show interface** command only displays the IPv4 settings for an interface. To see the IPv6 configuration on an interface, you need to use the **show ipv6 interface** command. The **show ipv6 interface** command does not display any IPv4 settings for the interface (if both are configured on the interface).

The show ipv6 route Command

To display the routes in the IPv6 routing table, enter the following command:

```
hostname# show ipv6 route
```

The output from the **show ipv6 route** command is similar to the IPv4 **show route** command. It displays the following information:

- The protocol that derived the route.
- The IPv6 prefix of the remote network.
- The administrative distance and metric for the route.
- The address of the next-hop router.
- The interface through which the next hop router to the specified network is reached.

The following is sample output from the **show ipv6 route** command:

```
hostname# show ipv6 route

IPv6 Routing Table - 7 entries
Codes: C - Connected, L - Local, S - Static, R - RIP, B - BGP
       U - Per-user Static route
       I1 - ISIS L1, I2 - ISIS L2, IA - ISIS interarea
       O - OSPF intra, OI - OSPF inter, OE1 - OSPF ext 1, OE2 - OSPF ext 2
L fe80::/10 [0/0]
  via ::, inside
L fec0::a:0:0:a0a:a70/128 [0/0]
  via ::, inside
C fec0:0:0:a::/64 [0/0]
  via ::, inside
L ff00::/8 [0/0]
  via ::, inside
```

Configuring a Dual IP Stack on an Interface

The security appliance supports the configuration of both IPv6 and IPv4 on an interface. You do not need to enter any special commands to do so; simply enter the IPv4 configuration commands and IPv6 configuration commands as you normally would. Make sure you configure the default route for both IPv4 and IPv6.

IPv6 Configuration Example

Example 9-1 shows several features of IPv6 configuration:

- Each interface is configured with both IPv6 and IPv4 addresses.
- The IPv6 default route is set with the **ipv6 route** command.
- An IPv6 access list is applied to the outside interface.

Example 9-1 IPv6 Configuration Example

```

interface Ethernet0
  speed auto
  duplex auto
  nameif outside
  security-level 0
  ip address 16.142.10.100 255.255.255.0
  ipv6 address 2001:400:3:1::100/64
  ipv6 nd suppress-ra
  ospf mtu-ignore auto
!
interface Ethernet1
  speed auto
  duplex auto
  nameif inside
  security-level 100
  ip address 16.140.10.100 255.255.255.0
  ipv6 address 2001:400:1:1::100/64
  ospf mtu-ignore auto
!
enable password 8Ry2YjIyt7RRXU24 encrypted
passwd 2KFQnbNIdI.2KYOU encrypted
hostname coyupix
boot system flash:/cdisk.7.0.0.16
ftp mode passive
names
access-list allow extended permit icmp any any
pager lines 24
logging enable
logging buffered debugging
mtu outside 1500
mtu inside 1500
ipv6 route outside ::/0 2001:400:3:1::1
ipv6 access-list outacl permit icmp6 2001:400:2:1::/64 2001:400:1:1::/64
ipv6 access-list outacl permit tcp 2001:400:2:1::/64 2001:400:1:1::/64 eq telnet
ipv6 access-list outacl permit tcp 2001:400:2:1::/64 2001:400:1:1::/64 eq ftp
ipv6 access-list outacl permit tcp 2001:400:2:1::/64 2001:400:1:1::/64 eq www
no failover
monitor-interface outside
monitor-interface inside
asdm image
no asdm history enable
arp timeout 14400
access-group allow in interface outside
access-group outacl in interface outside
route outside 0.0.0.0 0.0.0.0 16.142.10.1 1
timeout xlate 3:00:00
timeout conn 1:00:00 half-closed 0:10:00 udp 0:02:00 icmp 0:02:00 rpc 0:10:00 h323 0:05:00
h225 1:00:00 mgcp 0:05:00 mgcp-pat 0:05:00 sip 0:30:00 sip_media 0:02:00
timeout uauth 0:05:00 absolute
no snmp-server location
no snmp-server contact

```

```
snmp-server enable traps snmp
fragment size 200 outside
fragment chain 24 outside
fragment size 200 inside
fragment chain 24 inside
sysopt nodnsalias inbound
sysopt nodnsalias outbound
telnet timeout 5
ssh timeout 5
console timeout 0
!
class-map inspection_default
  match default-inspection-traffic
!
!
policy-map global_policy
  class inspection_default
    inspect dns
    inspect ftp
    inspect h323 h225
    inspect h323 ras
    inspect rsh
    inspect smtp
    inspect sqlnet
    inspect sip
    inspect skinny
    inspect rpc
    inspect xdmcp
    inspect netbios
    inspect mgcp
    inspect tftp
    inspect snmp
  !
terminal width 80
service-policy global_policy global
Cryptochecksum:0000000000000000000000000000000000000000000000000000000000000000
: end
```



Configuring AAA Servers and the Local Database

This chapter describes support for AAA (pronounced “triple A”) and how to configure AAA servers and the local database.

This chapter contains the following sections:

- [AAA Overview, page 10-1](#)
- [AAA Server and Local Database Support, page 10-3](#)
- [Configuring the Local Database, page 10-9](#)
- [Identifying AAA Server Groups and Servers, page 10-11](#)

AAA Overview

AAA enables the security appliance to determine who the user is (authentication), what the user can do (authorization), and what the user did (accounting).

AAA provides an extra level of protection and control for user access than using ACLs alone. For example, you can create an ACL allowing all outside users to access Telnet on a server on the DMZ network. If you want only some users to access the server and you might not always know IP addresses of these users, you can enable AAA to allow only authenticated and/or authorized users to make it through the security appliance. (The Telnet server enforces authentication, too; the security appliance prevents unauthorized users from attempting to access the server.)

You can use authentication alone or with authorization and accounting. Authorization always requires a user to be authenticated first. You can use accounting alone, or with authentication and authorization.

This section includes the following topics:

- [About Authentication, page 10-2](#)
- [About Authorization, page 10-2](#)
- [About Accounting, page 10-2](#)

About Authentication

Authentication controls access by requiring valid user credentials, which are typically a username and password. You can configure the security appliance to authenticate the following items:

- All administrative connections to the security appliance including the following sessions:
 - Telnet
 - SSH
 - Serial console
 - ASDM (using HTTPS)
 - VPN management access
- The **enable** command
- Network access
- VPN access

About Authorization

Authorization controls access *per user* after users authenticate. You can configure the security appliance to authorize the following items:

- Management commands
- Network access
- VPN access

Authorization controls the services and commands available to each authenticated user. Were you not to enable authorization, authentication alone would provide the same access to services for all authenticated users.

If you need the control that authorization provides, you can configure a broad authentication rule, and then have a detailed authorization configuration. For example, you authenticate inside users who attempt to access any server on the outside network and then limit the outside servers that a particular user can access using authorization.

The security appliance caches the first 16 authorization requests per user, so if the user accesses the same services during the current authentication session, the security appliance does not resend the request to the authorization server.

About Accounting

Accounting tracks traffic that passes through the security appliance, enabling you to have a record of user activity. If you enable authentication for that traffic, you can account for traffic per user. If you do not authenticate the traffic, you can account for traffic per IP address. Accounting information includes when sessions start and stop, username, the number of bytes that pass through the security appliance for the session, the service used, and the duration of each session.

AAA Server and Local Database Support

The security appliance supports a variety of AAA server types and a local database that is stored on the security appliance. This section describes support for each AAA server type and the local database.

This section contains the following topics:

- [Summary of Support, page 10-3](#)
- [RADIUS Server Support, page 10-4](#)
- [TACACS+ Server Support, page 10-5](#)
- [SDI Server Support, page 10-6](#)
- [NT Server Support, page 10-7](#)
- [Kerberos Server Support, page 10-7](#)
- [LDAP Server Support, page 10-8](#)
- [Local Database Support, page 10-8](#)

Summary of Support

Table 10-1 summarizes the support for each AAA service by each AAA server type, including the local database. For more information about support for a specific AAA server type, refer to the topics following the table.

Table 10-1 Summary of AAA Support

AAA Service	Database Type						
	Local	RADIUS	TACACS+	SDI	NT	Kerberos	LDAP
Authentication of . . .							
VPN users	Yes	Yes	Yes	Yes	Yes	Yes	No
Firewall sessions	Yes	Yes	Yes	No	No	No	No
Administrators	Yes	Yes	Yes	No	No	No	No
Authorization of . . .							
VPN users	Yes	Yes	No	No	No	No	Yes
Firewall sessions	No	Yes ¹	Yes	No	No	No	No
Administrators	Yes ²	No	Yes	No	No	No	No
Accounting of . . .							
VPN connections	No	Yes	Yes	No	No	No	No
Firewall sessions	No	Yes	Yes	No	No	No	No
Administrators	No	Yes	Yes	No	No	No	No

1. For firewall sessions, RADIUS authorization is supported with user-specific ACLs only, which are received or specified in a RADIUS authentication response.
2. Local command authorization is supported by privilege level only.

RADIUS Server Support

The security appliance supports RADIUS servers.

This section contains the following topics:

- [Authentication Methods, page 10-4](#)
- [Attribute Support, page 10-4](#)
- [RADIUS Functions, page 10-4](#)

Authentication Methods

The security appliance supports the following authentication methods with RADIUS:

- PAP
- CHAP
- MS-CHAPv1
- MS-CHAPv2 (including password aging), for IPSec users only

Attribute Support

The security appliance supports the following sets of RADIUS attributes:

- Authentication attributes defined in RFC 2138.
- Accounting attributes defined in RFC 2139.
- RADIUS attributes for tunneled protocol support, defined in RFC 2868.
- Cisco IOS VSAs, identified by RADIUS vendor ID 9.
- Cisco VPN-related VSAs, identified by RADIUS vendor ID 3076.
- Microsoft VSAs, defined in RFC 2548.

RADIUS Functions

The security appliance can use RADIUS servers for the functionality described in [Table 10-2](#).

Table 10-2 RADIUS Functions

Functions	Description
User authentication for CLI access	When a user attempts to access the security appliance with Telnet, SSH, HTTP, or a serial console connection and the traffic matches an authentication statement, the security appliance challenges the user for a username and password, sends these credentials to the RADIUS server, and grants or denies user CLI access based on the response from the server.
User authentication for the enable command	When a user attempts to access the enable command, the security appliance challenges the user for a password, sends to the RADIUS server the username and enable password, and grants or denies user access to enable mode based on the response from the server.
Accounting for CLI access	You can configure the security appliance to send accounting information to a RADIUS server about administrative sessions.

Table 10-2 RADIUS Functions (continued)

Functions	Description
User authentication for network access	When a user attempts to access networks through the security appliance and the traffic matches an authentication statement, the security appliance sends to the RADIUS server the user credentials (typically a username and password) and grants or denies user network access based on the response from the server.
User authorization for network access using dynamic ACLs per user	To implement dynamic ACLs, you must configure the RADIUS server to support it. When the user authenticates, the RADIUS server sends a downloadable ACL to the security appliance. Access to a given service is either permitted or denied by the ACL. The security appliance deletes the ACL when the authentication session expires.
User authorization for network access using a downloaded ACL name per user	To implement downloaded ACL names, you must configure the RADIUS server to support it. When the user authenticates, the RADIUS server sends a name of an ACL. If an ACL with the name specified exists on the security appliance, access to a given service is either permitted or denied by the ACL. You can specify the same ACL for multiple users.
VPN authentication	When a user attempts to establish VPN access and the applicable tunnel-group record specifies a RADIUS authentication server group, the security appliance sends to the RADIUS server the username and password, and then grants or denies user access based on the response from the server.
VPN authorization	When user authentication for VPN access has succeeded and the applicable tunnel-group record specifies a RADIUS authorization server group, the security appliance sends a request to the RADIUS authorization server and applies to the VPN session the authorizations received.
VPN accounting	When user authentication for VPN access has succeeded and the applicable tunnel-group record specifies a RADIUS accounting server group, the security appliance sends the RADIUS server group accounting data about the VPN session.
Accounting for network access per user or IP address	You can configure the security appliance to send accounting information to a RADIUS server about any traffic that passes through the security appliance.

TACACS+ Server Support

The security appliance can use TACACS+ servers for the functionality described in [Table 10-3](#). The security appliance supports TACACS+ authentication with ASCII, PAP, CHAP, and MS-CHAPv1.

Table 10-3 TACACS+ Functions

Functions	Description
User authentication for CLI access	When a user attempts to access the security appliance with Telnet, SSH, HTTP, or a serial console connection and the traffic matches an authentication statement, the security appliance challenges the user for a username and password, sends these credentials to the TACACS+ server, and grants or denies user CLI access based on the response from the server.
User authentication for the enable command	When a user attempts to access the enable command, the security appliance challenges the user for a password, sends to the TACACS+ server the username and enable password, and grants or denies user access to enable mode based on the response from the server.

Table 10-3 TACACS+ Functions (continued)

Functions	Description
Accounting for CLI access	You can configure the security appliance to send accounting information to a TACACS+ server about administrative sessions.
User authentication for network access	When a user attempts to access networks through the security appliance and the traffic matches an authentication statement, the security appliance sends to the TACACS+ server the user credentials (typically a username and password) and grants or denies user network access based on the response from the server.
User authorization for network access	When a user matches an authorization statement on the security appliance after authenticating, the security appliance consults the TACACS+ server for user access privileges.
VPN authentication	When a user attempts to establish VPN access and the applicable tunnel-group record specifies a TACACS+ authentication server group, the security appliance sends to the TACACS+ server the username and password, and then grants or denies user access based on the response from the server.
VPN accounting	When user authentication for VPN access has succeeded and the applicable tunnel-group record specifies a TACACS+ accounting server group, the security appliance sends the TACACS+ server group accounting data about the VPN session.
User authorization for management commands.	On the TACACS+ server, configure the commands that a user can use after authenticating for CLI access. Each command that a user enters at the CLI is checked by the TACACS+ server.
Accounting for network access per user or IP address	You can configure the security appliance to send accounting information to the TACACS+ server about any traffic that passes through the security appliance.

SDI Server Support

The security appliance can use RSA SecureID servers for VPN authentication. These servers are also known as SDI servers. When a user attempts to establish VPN access and the applicable tunnel-group record specifies a SDI authentication server group, the security appliance sends to the SDI server the username and one-time password and grants or denies user access based on the response from the server.

This section contains the following topics:

- [SDI Version Support, page 10-6](#)
- [Two-step Authentication Process, page 10-7](#)
- [SDI Primary and Replica Servers, page 10-7](#)

SDI Version Support

The security appliance offers the following SDI version support:

- **Versions prior to version 5.0**—SDI versions prior to 5.0 use the concept of an SDI master and an SDI slave server which share a single node secret file (SECURID).
- **Versions 5.0**—SDI version 5.0 uses the concepts of an SDI primary and SDI replica servers. Each primary and its replicas share a single node secret file. The node secret file has its name based on the hexadecimal value of the ACE/Server IP address with .sdi appended.

A version 5.0 SDI server that you configure on the security appliance can be either the primary or any one of the replicas. See the “[SDI Primary and Replica Servers](#)” section on page 10-7 for information about how the SDI agent selects servers to authenticate users.

Two-step Authentication Process

SDI version 5.0 uses a two-step process to prevent an intruder from capturing information from an RSA SecurID authentication request and using it to authenticate to another server. The Agent first sends a lock request to the SecurID server before sending the user authentication request. The server locks the username, preventing another (replica) server from accepting it. This means that the same user cannot authenticate to two security appliances using the same authentication servers simultaneously. After a successful username lock, the security appliance sends the passcode.

SDI Primary and Replica Servers

The security appliance obtains the server list when the first user authenticates to the configured server, which can be either a primary or a replica. The security appliance then assigns priorities to each of the servers on the list, and subsequent server selection derives at random from those assigned priorities. The highest priority servers have a higher likelihood of being selected.

NT Server Support

The security appliance supports VPN authentication with Microsoft Windows server operating systems that support NTLM version 1, which we collectively refer to as NT servers. When a user attempts to establish VPN access and the applicable tunnel-group record specifies a NT authentication server group, the security appliance uses NTLM version 1 to for user authentication with the Microsoft Windows domain server. The security appliance grants or denies user access based on the response from the domain server.

**Note**

NT servers have a maximum length of 14 characters for user passwords. Longer passwords are truncated. This is a limitation of NTLM version 1.

Kerberos Server Support

The security appliance can use Kerberos servers for VPN authentication. When a user attempts to establish VPN access through the security appliance, and the traffic matches an authentication statement, the security appliance consults the Kerberos server for user authentication and grants or denies user access based on the response from the server.

The security appliance supports 3DES, DES, and RC4 encryption types.

**Note**

The security appliance does not support changing user passwords during tunnel negotiation. To avoid this situation happening inadvertently, disable password expiration on the Kerberos/Active Directory server for users connecting to the security appliance.

LDAP Server Support

The security appliance can use LDAP servers for VPN authorization. When user authentication for VPN access has succeeded and the applicable tunnel-group record specifies an LDAP authorization server group, the security appliance queries the LDAP server and applies to the VPN session the authorizations it receives.

Local Database Support

The security appliance maintains a local database that you can populate with user profiles.

This section contains the following topics:

- [User Profiles, page 10-8](#)
- [Local Database Functions, page 10-8](#)
- [Fallback Support, page 10-9](#)

User Profiles

User profiles contain, at a minimum, a username. Typically, a password is assigned to each username, although passwords are optional.

The **username attributes** command enables you to enter the username mode. In this mode, you can add other information to a specific user profile. The information you can add includes VPN-related attributes, such as a VPN session timeout value.

Local Database Functions

The security appliance can use local database for the functionality described in [Table 10-4](#).

Table 10-4 Local Database Functions

Functions	Description
User authentication for CLI access	When a user attempts to access the security appliance with Telnet, SSH, HTTP, or a serial console connection and the traffic matches an authentication statement, the security appliance challenges the user for a username and password, checks these credentials against the local database, and grants or denies user CLI access based on the result.
User authentication for the enable or login command	When a user attempts to access the enable command, the security appliance challenges the user for a password, checks the username and password against the local database, and grants or denies user access to enable mode based on the result.
User authorization for management commands.	When a user authenticates with the enable command (or logs in with the login command), the security appliance places that user in the privilege level defined by the local database. You can configure each command to belong to privilege level between 0 and 15 on the security appliance.
User authentication for network access	When a user attempts to access networks through the security appliance and the traffic matches an authentication statement, the security appliance challenges the user for a username and password, checks these credentials against the local database, and grants or denies user network access based on the result.

Table 10-4 Local Database Functions (continued)

Functions	Description
VPN authentication	When a user attempts to establish VPN access and the traffic matches an authentication statement, the security appliance checks the username and password received against the local user database, and grants or denies VPN access based on the result.
VPN authorization	When user authentication for VPN access has succeeded, the security appliance applies to the VPN session the attributes from the local database that are associated with the username and the applicable group policy.

Fallback Support

With the exception of fallback for network access authentication, the local database can act as a fallback method for the functions in Table 10-4. This behavior is designed to help you prevent accidental lockout from the security appliance.

For users who need fallback support, we recommend that their usernames and passwords in the local database match their usernames and passwords in the AAA servers. This provides transparent fallback support. Because the user cannot determine whether a AAA server or the local database is providing the service, using usernames and passwords on AAA servers that are different than the usernames and passwords in the local database means that the user cannot be certain which username and password should be given.

The local database supports the following fallback functions:

- **Console and enable password authentication**—When you use the **aaa authentication console** command, you can add the **LOCAL** keyword after the AAA server group tag. If the servers in the group all are unavailable, the security appliance uses the local database to authenticate administrative access. This can include enable password authentication, too.
- **Command authorization**—When you use the **aaa authorization command** command, you can add the **LOCAL** keyword after the AAA server group tag. If the TACACS+ servers in the group all are unavailable, the local database is used to authorize commands based on privilege levels.
- **VPN authentication and authorization**—VPN authentication and authorization are supported to enable remote access to the security appliance if AAA servers that normally support these VPN services are unavailable. The **authentication-server-group** command, available in tunnel-group general attributes mode, lets you specify the **LOCAL** keyword when you are configuring attributes of a tunnel group. When VPN client of an administrator specifies a tunnel group configured to fallback to the local database, the VPN tunnel can be established even if the AAA server group is unavailable, provided that the local database is configured with the necessary attributes.

Configuring the Local Database

This section describes how to manage users in the local database. You can use the local database for CLI access authentication, privileged mode authentication, command authorization, network access authentication, and VPN authentication and authorization. You cannot use the local database for network access authorization. The local database does not support accounting.

For multiple context mode, you can configure usernames in the system execution space to provide individual logins using the **login** command; however, you cannot configure any **aaa** commands in the system execution space.

**Caution**

If you add to the local database users who can gain access to the CLI but who should not be allowed to enter privileged mode, enable command authorization. (See the “[Configuring Local Command Authorization](#)” section on page 31-7.) Without command authorization, users can access privileged mode (and all commands) at the CLI using their own password if their privilege level is 2 or greater (2 is the default). Alternatively, you can use RADIUS or TACACS+ authentication so that the user will not be able to use the **login** command, or you can set all local users to level 1 so you can control who can use the system enable password to access privileged mode.

To define a user account in the local database, perform the following steps:

Step 1 Create the user account. To do so, enter the following command:

```
hostname/contexta(config)# username username {nopassword | password password} [encrypted]
[privilege level]
```

where the options are as follows:

- **username**—A string from 4 to 64 characters long.
- **password** *password*—A string from 3 to 16 characters long. In version 7.0(5), the password can be up to 32 characters long.
- **encrypted**—Indicates that the password specified is encrypted.
- **privilege** *level*—The privilege level that you want to assign to the new user account (from 0 to 15). The default is 2. This privilege level is used with command authorization.
- **nopassword**—Creates a user account with no password.

Step 2 To configure a local user account with VPN attributes, follow these steps:

a. Enter the following command:

```
hostname/contexta(config)# username username attributes
```

When you enter a **username attributes** command, you enter username mode. The commands available in this mode are as follows:

- **group-lock**
- **password-storage**
- **vpn-access-hours**
- **vpn-filter**
- **vpn-framed-ip-address**
- **vpn-group-policy**
- **vpn-idle-timeout**
- **vpn-session-timeout**
- **vpn-simultaneous-logins**
- **vpn-tunnel-protocol**
- **webvpn**

Use these commands as needed to configure the user profile. For more information about these commands, see the *Cisco Security Appliance Command Line Configuration Reference*.

- b. When you have finished configuring the user profiles, enter **exit** to return to config mode.

For example, the following command assigns a privilege level of 15 to the admin user account:

```
hostname/contexta(config)# username admin password passw0rd privilege 15
```

The following command creates a user account with no password:

```
hostname/contexta(config)# username bcham34 nopassword
```

The following commands create a user account with a password, enter username mode, and specify a few VPN attributes:

```
hostname/contexta(config)# username rwilliams password gOgeOus
hostname/contexta(config)# username rwilliams attributes
hostname/contexta(config-username)# vpn-tunnel-protocol IPSec
hostname/contexta(config-username)# vpn-simultaneous-logins 6
hostname/contexta(config-username)# exit
```

Identifying AAA Server Groups and Servers

If you want to use an external AAA server for authentication, authorization, or accounting, you must first create at least one AAA server group per AAA protocol and add one or more servers to each group. You identify AAA server groups by name. Each server group is specific to one type of server: Kerberos, LDAP, NT, RADIUS, SDI, or TACACS+.

The security appliance contacts the first server in the group. If that server is unavailable, the security appliance contacts the next server in the group, if configured. If all servers in the group are unavailable, the security appliance tries the local database if you configured it as a fallback method (management authentication and authorization only). If you do not have a fallback method, the security appliance continues to try the AAA servers.

To create a server group and add AAA servers to it, follow these steps:

Step 1 For each AAA server group you need to create, follow these steps:

- a. Identify the server group name and the protocol. To do so, enter the following command:

```
hostname/contexta(config)# aaa-server server_group protocol {kerberos | ldap | nt |
radius | sdi | tacacs+}
```

For example, to use RADIUS to authenticate network access and TACACS+ to authenticate CLI access, you need to create at least two server groups, one for RADIUS servers and one for TACACS+ servers.

You can have up to 15 single-mode server groups or 4 multi-mode server groups. Each server group can have up to 16 servers in single mode or up to 4 servers in multi-mode.

When you enter a **aaa-server protocol** command, you enter group mode.

- b. If you want to specify the maximum number of requests sent to a AAA server in the group before trying the next server, enter the following command:

```
hostname/contexta(config-aaa-server-group)# max-failed-attempts number
```

The *number* can be between 1 and 5. The default is 3.

If you configured a fallback method using the local database (for management access only; see the “Authenticating and Authorizing System Administrators” section on page 31-4 and the “Configuring TACACS+ Command Authorization” section on page 31-11 to configure the fallback mechanism), and all the servers in the group fail to respond, then the group is considered to be unresponsive, and the fallback method is tried. The server group remains marked as unresponsive for a period of 10 minutes (by default) so that additional AAA requests within that period do not attempt to contact the server group, and the fallback method is used immediately. To change the unresponsive period from the default, see the **reactivation-mode** command in the following step.

If you do not have a fallback method, the security appliance continues to retry the servers in the group.

- c. If you want to specify the method (reactivation policy) by which failed servers in a group are reactivated, use the **reactivation-mode** command. For more information about this command, see the *Cisco Security Appliance Command Reference*.
- d. If you want to indicate whether accounting messages are sent to a single server (single mode) or sent to all servers in the group (simultaneous mode), use the **accounting-mode** command. For more information about this command, see the *Cisco Security Appliance Command Reference*.
- e. When you have finished configuring the AAA server group, enter **exit**.

Step 2 For each AAA server on your network, follow these steps:

- a. Identify the server, including the AAA server group it belongs to. To do so, enter the following command:

```
hostname/contexta(config)# aaa-server server_group (interface_name) host server_ip
```

When you enter a **aaa-server host** command, you enter host mode.

- b. As needed, use host mode commands to further configure the AAA server.

The commands in host mode do not apply to all AAA server types. Table 10-5 lists the available commands, the server types they apply to, and whether a new AAA server definition has a default value for that command. Where a command is applicable to the server type you specified and no default value is provided (indicated by “—”), use the command to specify the value. For more information about these commands, see the *Cisco Security Appliance Command Reference*.

Table 10-5 Host Mode Commands, Server Types, and Defaults

Command	Applicable AAA Server Types	Default Value
accounting-port	RADIUS	1646
acl-netmask-convert	RADIUS	standard
authentication-port	RADIUS	1645
kerberos-realm	Kerberos	—
key	RADIUS	—
	TACACS+	—
ldap-base-dn	LDAP	—
ldap-login-dn	LDAP	—
ldap-login-password	LDAP	—
ldap-naming-attribute	LDAP	—
ldap-scope	LDAP	—
nt-auth-domain-controller	NT	—

Table 10-5 Host Mode Commands, Server Types, and Defaults (continued)

Command	Applicable AAA Server Types	Default Value
radius-common-pw	RADIUS	—
retry-interval	Kerberos	10 seconds
	RADIUS	10 seconds
sdi-pre-5-slave	SDI	—
sdi-version	SDI	sdi-5
server-port	Kerberos	88
	LDAP	389
	NT	139
	SDI	5500
	TACACS+	49
timeout	All	10 seconds

- c. When you have finished configuring the AAA server host, enter **exit**.

For example, to add one TACACS+ group with one primary and one backup server, one RADIUS group with a single server, and an NT domain server, enter the following commands:

```
hostname/contexta(config)# aaa-server AuthInbound protocol tacacs+
hostname/contexta(config-aaa-server-group)# max-failed-attempts 2
hostname/contexta(config-aaa-server-group)# reactivation-mode depletion deadtime 20
hostname/contexta(config-aaa-server-group)# exit
hostname/contexta(config)# aaa-server AuthInbound (inside) host 10.1.1.1
hostname/contexta(config-aaa-server-host)# key TACPlusUauthKey
hostname/contexta(config-aaa-server-host)# exit
hostname/contexta(config)# aaa-server AuthInbound (inside) host 10.1.1.2
hostname/contexta(config-aaa-server-host)# key TACPlusUauthKey2
hostname/contexta(config-aaa-server-host)# exit
hostname/contexta(config)# aaa-server AuthOutbound protocol radius
hostname/contexta(config-aaa-server-group)# exit
hostname/contexta(config)# aaa-server AuthOutbound (inside) host 10.1.1.3
hostname/contexta(config-aaa-server-host)# key RadUauthKey
hostname/contexta(config-aaa-server-host)# exit
hostname/contexta(config)# aaa-server NTAAuth protocol nt
hostname/contexta(config-aaa-server-group)# exit
hostname/contexta(config)# aaa-server NTAAuth (inside) host 10.1.1.4
hostname/contexta(config-aaa-server-host)# nt-auth-domain-controller primary1
hostname/contexta(config-aaa-server-host)# exit
```



Configuring Failover

This chapter describes the security appliance failover feature, which lets you configure two security appliances so that one will take over operation if the other one fails.

This chapter includes the following sections:

- [Understanding Failover, page 11-1](#)
- [Configuring Failover, page 11-16](#)
- [Controlling and Monitoring Failover, page 11-45](#)
- [Failover Configuration Examples, page 11-47](#)

Understanding Failover

The failover configuration requires two identical security appliances connected to each other through a dedicated failover link and, optionally, a Stateful Failover link. The health of the active interfaces and units is monitored to determine if specific failover conditions are met. If those conditions are met, failover occurs.

The security appliance supports two failover configurations, Active/Active failover and Active/Standby failover. Each failover configuration has its own method for determining and performing failover.

With Active/Active failover, both units can pass network traffic. This lets you configure load balancing on your network. Active/Active failover is only available on units running in multiple context mode.

With Active/Standby failover, only one unit passes traffic while the other unit waits in a standby state. Active/Standby failover is available on units running in either single or multiple context mode.

Both failover configurations support stateful or stateless (regular) failover.



Note

VPN failover is not supported on units running in multiple context mode. VPN failover available for Active/Standby failover configurations only.

This section includes the following topics:

- [Failover System Requirements, page 11-2](#)
- [The Failover and Stateful Failover Links, page 11-3](#)
- [Active/Active and Active/Standby Failover, page 11-6](#)
- [Regular and Stateful Failover, page 11-14](#)
- [Failover Health Monitoring, page 11-15](#)

Failover System Requirements

This section describes the hardware, software, and license requirements for security appliances in a failover configuration. This section contains the following topics:

- [Hardware Requirements, page 11-2](#)
- [Software Requirements, page 11-2](#)
- [License Requirements, page 11-2](#)

Hardware Requirements

The two units in a failover configuration must have the same hardware configuration. They must be the same model, have the same number and types of interfaces, and the same amount of RAM.

**Note**

The two units do not have to have the same size Flash memory. If using units with different Flash memory sizes in your failover configuration, make sure the unit with the smaller Flash memory has enough space to accommodate the software image files and the configuration files. If it does not, configuration synchronization from the unit with the larger Flash memory to the unit with the smaller Flash memory will fail.

Software Requirements

The two units in a failover configuration must be in the operating modes (routed or transparent, single or multiple context). They have the same major (first number) and minor (second number) software version. However, you can use different versions of the software during an upgrade process; for example, you can upgrade one unit from Version 7.0(1) to Version 7.0(2) and have failover remain active. We recommend upgrading both units to the same version to ensure long-term compatibility.

License Requirements

On the PIX security appliance platform, at least one of the units must have an unrestricted (UR) license. The other unit can have a Failover Only (FO) license, a Failover Only Active-Active (FO_AA) license, or another UR license. Units with a Restricted license cannot be used for failover, and two units with FO or FO_AA licenses cannot be used together as a failover pair.

**Note**

The FO license does not support Active/Active failover.

On the ASA security appliance platform, both units must have the same hardware, software, and licensing to support failover. On the ASA 5505 and ASA 5520, both units must have a Security Plus license to support failover.

The FO and FO_AA licenses are intended to be used solely for units in a failover configuration and not for units in standalone mode. If a failover unit with one of these licenses is used in standalone mode, the unit will reboot at least once every 24 hours until the unit is returned to failover duty. A unit with an FO or FO_AA license operates in standalone mode if it is booted without being connected to a failover peer with a UR license. If the unit with a UR license in a failover pair fails and is removed from the configuration, the unit with the FO or FO_AA license will not automatically reboot every 24 hours; it will operate uninterrupted unless the it is manually rebooted.

When the unit automatically reboots, the following message displays on the console:

```
=====NOTICE=====
      This machine is running in secondary mode without
      a connection to an active primary PIX. Please
      check your connection to the primary system.

      REBOOTING...
=====
```

The ASA platform does not have this restriction.

The Failover and Stateful Failover Links

This section describes the failover and the Stateful Failover links, which are dedicated connections between the two units in a failover configuration. This section includes the following topics:

- [Failover Link, page 11-3](#)
- [Stateful Failover Link, page 11-5](#)

Failover Link

The two units in a failover pair constantly communicate over a failover link to determine the operating status of each unit. The following information is communicated over the failover link:

- The unit state (active or standby).
- Power status (cable-based failover only—available only on the Cisco PIX security appliance platform).
- Hello messages (keep-alives).
- Network link status.
- MAC address exchange.
- Configuration replication and synchronization.



Caution

All information sent over the failover and Stateful Failover links is sent in clear text unless you secure the communication with a failover key. If the security appliance is used to terminate VPN tunnels, this information includes any usernames, passwords and preshared keys used for establishing the tunnels. Transmitting this sensitive data in clear text could pose a significant security risk. We recommend securing the failover communication with a failover key if you are using the security appliance to terminate VPN tunnels.

On the PIX security appliance, the failover link can be either a LAN-based connection or a dedicated serial Failover cable. On the ASA platform, the failover link can only be a LAN-based connection.

This section includes the following topics:

- [LAN-Based Failover Link, page 11-4](#)
- [Serial Cable Failover Link \(PIX Security Appliance Only\), page 11-4](#)

LAN-Based Failover Link

You can use any unused Ethernet interface on the device as the failover link; however, you cannot specify an interface that is currently configured with a name. The LAN failover link interface is not configured as a normal networking interface. It exists for failover communication only. This interface should only be used for the LAN failover link (and optionally for the stateful failover link).

Connect the LAN failover link in one of the following two ways:

- Using a switch, with no other device on the same network segment (broadcast domain or VLAN) as the LAN failover interfaces of the ASA.
- Using a crossover Ethernet cable to connect the appliances directly, without the need for an external switch.

**Note**

When you use a crossover cable for the LAN failover link, if the LAN interface fails, the link is brought down on both peers. This condition may hamper troubleshooting efforts because you cannot easily determine which interface failed and caused the link to come down.

**Note**

The ASA supports Auto-MDI/MDIX on its copper Ethernet ports, so you can either use a crossover cable or a straight-through cable. If you use a straight-through cable, the interface automatically detects the cable and swaps one of the transmit/receive pairs to MDIX.

Serial Cable Failover Link (PIX Security Appliance Only)

The serial failover cable, or “cable-based failover,” is only available on the PIX security appliance platform. If the two units are within six feet of each other, then we recommend that you use the serial failover cable.

The cable that connects the two units is a modified RS-232 serial link cable that transfers data at 117,760 bps (115 Kbps). One end of the cable is labeled “Primary.” The unit attached to this end of the cable automatically becomes the primary unit. The other end of the cable is labeled “Secondary.” The unit attached to this end of the cable automatically becomes the secondary unit. You cannot override these designations in the PIX security appliance software. If you purchased a PIX security appliance failover bundle, this cable is included. To order a spare, use part number PIX-FO=.

The benefits of using cable-based failover include the following:

- The PIX security appliance can immediately detect a power loss on the peer unit, and it can differentiate a power loss from an unplugged cable.
- The standby unit can communicate with the active unit and can receive the entire configuration without having to be bootstrapped for failover. In LAN-based failover you need to configure the failover link on the standby unit before it can communicate with the active unit.
- The switch between the two units in LAN-based failover can be another point of hardware failure; cable-based failover eliminates this potential point of failure.
- You do not have to dedicate an Ethernet interface (and switch) to the failover link.
- The cable determines which unit is primary and which is secondary, eliminating the need to manually enter that information in the unit configurations.

The disadvantages of using cable-based failover include the following:

- Distance limitation—the units cannot be separated by more than 6 feet.
- Slower configuration replication.

Stateful Failover Link

To use Stateful Failover, you must configure a Stateful Failover link to pass all state information. You have three options for configuring a Stateful Failover link:

- You can use a dedicated Ethernet interface for the Stateful Failover link.
- If you are using LAN-based failover, you can share the failover link.
- You can share a regular data interface, such as the inside interface. However, this option is not recommended.

If you use a dedicated Ethernet interface for the Stateful Failover link, you can use either a switch or a crossover cable to directly connect the units. If you use a switch, no other hosts or routers should be on this link.



Note

Enable the PortFast option on Cisco switch ports that connect directly to the security appliance.

If you use a data interface as the Stateful Failover link, you will receive the following warning when you specify that interface as the Stateful Failover link:

```
***** WARNING ***** WARNING ***** WARNING ***** WARNING *****
  Sharing Stateful failover interface with regular data interface is not
  a recommended configuration due to performance and security concerns.
***** WARNING ***** WARNING ***** WARNING ***** WARNING *****
```

Sharing a data interface with the Stateful Failover interface can leave you vulnerable to replay attacks. Additionally, large amounts of Stateful Failover traffic may be sent on the interface, causing performance problems on that network segment.



Note

Using a data interface as the Stateful Failover interface is only supported in single context, routed mode.

In multiple context mode, the Stateful Failover link resides in the system context. This interface and the failover interface are the only interfaces in the system context. All other interfaces are allocated to and configured from within security contexts.



Note

The IP address and MAC address for the Stateful Failover link does not change at failover unless the Stateful Failover link is configured on a regular data interface.



Caution

All information sent over the failover and Stateful Failover links is sent in clear text unless you secure the communication with a failover key. If the security appliance is used to terminate VPN tunnels, this information includes any usernames, passwords, and preshared keys used for establishing the tunnels. Transmitting this sensitive data in clear text could pose a significant security risk. We recommend securing the failover communication with a failover key if you are using the security appliance to terminate VPN tunnels.

Failover Interface Speed for Stateful Links

If you use the failover link as the Stateful Failover link, you should use the fastest Ethernet interface available. If you experience performance problems on that interface, consider dedicating a separate interface for the Stateful Failover interface.

Use the following failover interface speed guidelines for Cisco PIX security appliances and Cisco ASA adaptive security appliances:

- Cisco ASA 5520/5540/5550 and PIX 515E/535
 - The stateful link speed should match the fastest data link
- Cisco ASA 5510 and PIX 525
 - Stateful link speed can be 100 Mbps, even though the data interface can operate at 1 Gigabit due to the CPU speed limitation.

For optimum performance when using long distance LAN failover, the latency for the failover link should be less than 10 milliseconds and no more than 250 milliseconds. If latency is more than 10 milliseconds, some performance degradation occurs due to retransmission of failover messages.

All platforms support sharing of failover heartbeat and stateful link, but we recommend using a separate heartbeat link on systems with high Stateful Failover traffic.

Active/Active and Active/Standby Failover

This section describes each failover configuration in detail. This section includes the following topics:

- [Active/Standby Failover, page 11-6](#)
- [Active/Active Failover, page 11-9](#)
- [Determining Which Type of Failover to Use, page 11-13](#)

Active/Standby Failover

This section describes Active/Standby failover and includes the following topics:

- [Active/Standby Failover Overview, page 11-6](#)
- [Primary/Secondary Status and Active/Standby Status, page 11-7](#)
- [Device Initialization and Configuration Synchronization, page 11-7](#)
- [Command Replication, page 11-8](#)
- [Failover Triggers, page 11-8](#)
- [Failover Actions, page 11-8](#)

Active/Standby Failover Overview

Active/Standby failover lets you use a standby security appliance to take over the functionality of a failed unit. When the active unit fails, it changes to the standby state while the standby unit changes to the active state. The unit that becomes active assumes the IP addresses (or, for transparent firewall, the management IP address) and MAC addresses of the failed unit and begins passing traffic. The unit that is now in standby state takes over the standby IP addresses and MAC addresses. Because network devices see no change in the MAC to IP address pairing, no ARP entries change or time out anywhere on the network.



Note

For multiple context mode, the security appliance can fail over the entire unit (including all contexts) but cannot fail over individual contexts separately.

Primary/Secondary Status and Active/Standby Status

The main differences between the two units in a failover pair are related to which unit is active and which unit is standby, namely which IP addresses to use and which unit actively passes traffic.

However, a few differences exist between the units based on which unit is primary (as specified in the configuration) and which unit is secondary:

- The primary unit always becomes the active unit if both units start up at the same time (and are of equal operational health).
- The primary unit MAC address is always coupled with the active IP addresses. The exception to this rule occurs when the secondary unit is active, and cannot obtain the primary MAC address over the failover link. In this case, the secondary MAC address is used.

Device Initialization and Configuration Synchronization

Configuration synchronization occurs when one or both devices in the failover pair boot. Configurations are always synchronized from the active unit to the standby unit. When the standby unit completes its initial startup, it clears its running configuration (except for the failover commands needed to communicate with the active unit), and the active unit sends its entire configuration to the standby unit.

The active unit is determined by the following:

- If a unit boots and detects a peer already running as active, it becomes the standby unit.
- If a unit boots and does not detect a peer, it becomes the active unit.
- If both units boot simultaneously, then the primary unit becomes the active unit and the secondary unit becomes the standby unit.



Note

If the secondary unit boots without detecting the primary unit, it becomes the active unit. It uses its own MAC addresses for the active IP addresses. However, when the primary unit becomes available, the secondary unit changes the MAC addresses to those of the primary unit, which can cause an interruption in your network traffic. To avoid this, configure the failover pair with virtual MAC addresses. See the [“Configuring Active/Standby Failover” section on page 11-16](#) for more information.

When the replication starts, the security appliance console on the active unit displays the message “Beginning configuration replication: Sending to mate,” and when it is complete, the security appliance displays the message “End Configuration Replication to mate.” During replication, commands entered on the active unit may not replicate properly to the standby unit, and commands entered on the standby unit may be overwritten by the configuration being replicated from the active unit. Avoid entering commands on either unit in the failover pair during the configuration replication process. Depending upon the size of the configuration, replication can take from a few seconds to several minutes.

On the standby unit, the configuration exists only in running memory. To save the configuration to Flash memory after synchronization:

- For single context mode, enter the **copy running-config startup-config** command on the active unit. The command is replicated to the standby unit, which proceeds to write its configuration to Flash memory.
- For multiple context mode, enter the **copy running-config startup-config** command on the active unit from the system execution space and from within each context on disk. The command is replicated to the standby unit, which proceeds to write its configuration to Flash memory. Contexts with startup configurations on external servers are accessible from either unit over the network and

do not need to be saved separately for each unit. Alternatively, you can copy the contexts on disk from the active unit to an external server, and then copy them to disk on the standby unit, where they become available when the unit reloads.

Command Replication

Command replication always flows from the active unit to the standby unit. As commands are entered on the active unit, they are sent across the failover link to the standby unit. You do not have to save the active configuration to Flash memory to replicate the commands.



Note

Changes made on the standby unit are not replicated to the active unit. If you enter a command on the standby unit, the security appliance displays the message `**** WARNING **** Configuration Replication is NOT performed from Standby unit to Active unit. Configurations are no longer synchronized.` This message displays even when you enter many commands that do not affect the configuration.

If you enter the **write standby** command on the active unit, the standby unit clears its running configuration (except for the failover commands used to communicate with the active unit), and the active unit sends its entire configuration to the standby unit.

For multiple context mode, when you enter the **write standby** command in the system execution space, all contexts are replicated. If you enter the **write standby** command within a context, the command replicates only the context configuration.

Replicated commands are stored in the running configuration. To save the replicated commands to the Flash memory on the standby unit:

- For single context mode, enter the **copy running-config startup-config** command on the active unit. The command is replicated to the standby unit, which proceeds to write its configuration to Flash memory.
- For multiple context mode, enter the **copy running-config startup-config** command on the active unit from the system execution space and within each context on disk. The command is replicated to the standby unit, which proceeds to write its configuration to Flash memory. Contexts with startup configurations on external servers are accessible from either unit over the network and do not need to be saved separately for each unit. Alternatively, you can copy the contexts on disk from the active unit to an external server, and then copy them to disk on the standby unit.

Failover Triggers

The unit can fail if one of the following events occurs:

- The unit has a hardware failure or a power failure.
- The unit has a software failure.
- Too many monitored interfaces fail.
- The **no failover active** command is entered on the active unit or the **failover active** command is entered on the standby unit.

Failover Actions

In Active/Standby failover, failover occurs on a unit basis. Even on systems running in multiple context mode, you cannot fail over individual or groups of contexts.

Table 11-1 shows the failover action for each failure event. For each failure event, the table shows the failover policy (failover or no failover), the action taken by the active unit, the action taken by the standby unit, and any special notes about the failover condition and actions.

Table 11-1 Failover Behavior

Failure Event	Policy	Active Action	Standby Action	Notes
Active unit failed (power or hardware)	Failover	n/a	Become active Mark active as failed	No hello messages are received on any monitored interface or the failover link.
Formerly active unit recovers	No failover	Become standby	No action	None.
Standby unit failed (power or hardware)	No failover	Mark standby as failed	n/a	When the standby unit is marked as failed, then the active unit will not attempt to fail over, even if the interface failure threshold is surpassed.
Failover link failed during operation	No failover	Mark failover interface as failed	Mark failover interface as failed	You should restore the failover link as soon as possible because the unit cannot fail over to the standby unit while the failover link is down.
Failover link failed at startup	No failover	Mark failover interface as failed	Become active	If the failover link is down at startup, both units will become active.
Stateful Failover link failed	No failover	No action	No action	State information will become out of date, and sessions will be terminated if a failover occurs.
Interface failure on active unit above threshold	Failover	Mark active as failed	Become active	None.
Interface failure on standby unit above threshold	No failover	No action	Mark standby as failed	When the standby unit is marked as failed, then the active unit will not attempt to fail over even if the interface failure threshold is surpassed.

Active/Active Failover

This section describes Active/Active failover. This section includes the following topics:

- [Active/Active Failover Overview, page 11-10](#)
- [Primary/Secondary Status and Active/Standby Status, page 11-10](#)
- [Device Initialization and Configuration Synchronization, page 11-10](#)
- [Command Replication, page 11-11](#)
- [Failover Triggers, page 11-12](#)
- [Failover Actions, page 11-12](#)

Active/Active Failover Overview

Active/Active failover is only available to security appliances in multiple context mode. In an Active/Active failover configuration, both security appliances can pass network traffic.

In Active/Active failover, you divide the security contexts on the security appliance into *failover groups*. A failover group is simply a logical group of one or more security contexts. You can create a maximum of two failover groups on the security appliance. The admin context is always a member of failover group 1, and any unassigned security contexts are also members of failover group 1 by default.

The failover group forms the base unit for failover in Active/Active failover. Interface failure monitoring, failover, and active/standby status are all attributes of a failover group, rather than the unit. When an active failover group fails, it changes to the standby state while the standby failover group becomes active. The interfaces in the failover group that becomes active assume the MAC and IP addresses of the interfaces in the failover group that failed. The interfaces in the failover group that is now in the standby state take over the standby MAC and IP addresses.

**Note**

A failover group failing on a unit does not mean that the unit has failed. The unit may still have another failover group passing traffic on it.

When creating the failover groups, you should create them on the unit that will have failover group 1 in the active state.

**Note**

Active/Active failover generates virtual MAC addresses for the interfaces in each failover group. If you have more than one Active/Active failover pair on the same network, it is possible to have the same default virtual MAC addresses assigned to the interfaces on one pair as are assigned to the interfaces of the other pairs because of the way the default virtual MAC addresses are determined. To avoid having duplicate MAC addresses on your network, make sure you assign each physical interface a virtual active and standby MAC address.

Primary/Secondary Status and Active/Standby Status

As in Active/Standby failover, one unit in an Active/Active failover pair is designated the primary unit, and the other unit the secondary unit. Unlike Active/Standby failover, this designation does not indicate which unit becomes active when both units start simultaneously. Instead, the primary/secondary designation determines which unit provides the running configuration to the pair and on which unit each failover group appears in the active state when both start simultaneously.

Each failover group in the configuration is given a primary or secondary unit preference. This preference determines on which unit in the failover pair the contexts in the failover group appear in the active state when both units start simultaneously. You can have both failover groups be in the active state on a single unit in the pair, with the other unit containing the failover groups in the standby state. However, a more typical configuration is to assign each failover group a different role preference to make each one active on a different unit, balancing the traffic across the devices.

**Note**

The security appliance does not provide load balancing services. Load balancing must be handled by a router passing traffic to the security appliance.

Device Initialization and Configuration Synchronization

Configuration synchronization occurs when one or both units in a failover pair boot.

When a unit boots while the peer unit is not available, then both failover groups become active on the unit regardless of the primary or secondary designation for the failover groups and the unit. Configuration synchronization does not occur. Some reasons a peer unit may not be available are that the peer unit is powered down, the peer unit is in a failed state, or the failover link between the units has not been established.

When a unit boots while the peer unit is active (with both failover groups active on it), the booting unit contacts the active unit to obtain the running configuration. By default, the failover groups will remain active on the active unit regardless of the primary or secondary preference of each failover group and unit designation. The failover groups remain active on that unit until either a failover occurs or until you manually force them to the other unit with the **no failover active** command. However, using the **preempt** command, you can configure each failover group to become active on its preferred unit when that unit becomes available. If a failover group is configured with the **preempt** command, the failover group automatically becomes active on the preferred unit when that unit becomes available.

When both units boot at the same time, the primary unit becomes the active unit. The secondary unit obtains the running configuration from the primary unit. Once the configuration has been synchronized, each failover group becomes active on the preferred unit.

Command Replication

After both units are running, commands are replicated from one unit to the other as follows:

- Commands entered within a security context are replicated from the unit on which the security context appears in the active state to the peer unit.



Note A context is considered in the active state on a unit if the failover group to which it belongs is in the active state on that unit.

- Commands entered in the system execution space are replicated from the unit on which failover group 1 is in the active state to the unit on which failover group 1 is in the standby state.
- Commands entered in the admin context are replicated from the unit on which failover group 1 is in the active state to the unit on which failover group 1 is in the standby state.

Failure to enter the commands on the appropriate unit for command replication to occur will cause the configurations to be out of synchronization. Those changes may be lost the next time the initial configuration synchronization occurs.

You can use the **write standby** command to resynchronize configurations that have become out of sync. For Active/Active failover, the **write standby** command behaves as follows:

- If you enter the **write standby** command in the system execution space, the system configuration and the configurations for all of the security contexts on the security appliance is written to the peer unit. This includes configuration information for security contexts that are in the standby state. You must enter the command in the system execution space on the unit that has failover group 1 in the active state.
- If you enter the **write standby** command in a security context, only the configuration for the security context is written to the peer unit. You must enter the command in the security context on the unit where the security context appears in the active state.

Replicated commands are not saved to the Flash memory when replicated to the peer unit. They are added to the running configuration. To save replicated commands to Flash memory on both units, use the **write memory** or **copy running-config startup-config** command on the unit that you made the changes on. The command will be replicated to the peer unit and cause the configuration to be saved to Flash memory on the peer unit.

Failover Triggers

In Active/Active failover, failover can be triggered at the unit level if one of the following events occurs:

- The unit has a hardware failure.
- The unit has a power failure.
- The unit has a software failure.
- The **no failover active** or the **failover active** command is entered in the system execution space.

Failover is triggered at the failover group level when one of the following events occurs:

- Too many monitored interfaces in the group fail.
- The **no failover active group** *group_id* command is entered.

You configure the failover threshold for each failover group by specifying the number or percentage of interfaces within the failover group that must fail before the group fails. Because a failover group can contain multiple contexts, and each context can contain multiple interfaces, it is possible for all interfaces in a single context to fail without causing the associated failover group to fail.

See the “[Failover Health Monitoring](#)” section on page 11-15 for more information about interface and unit monitoring.

Failover Actions

In an Active/Active failover configuration, failover occurs on a failover group basis, not a system basis. For example, if you designate both failover groups as active on the primary unit, and failover group 1 fails, then failover group 2 remains active on the primary unit while failover group 1 becomes active on the secondary unit.



Note

When configuring Active/Active failover, make sure that the combined traffic for both units is within the capacity of each unit.

[Table 11-2](#) shows the failover action for each failure event. For each failure event, the policy (whether or not failover occurs), actions for the active failover group, and actions for the standby failover group are given.

Table 11-2 Failover Behavior for Active/Active Failover

Failure Event	Policy	Active Group Action	Standby Group Action	Notes
A unit experiences a power or software failure	Failover	Become standby Mark as failed	Become active Mark active as failed	When a unit in a failover pair fails, any active failover groups on that unit are marked as failed and become active on the peer unit.
Interface failure on active failover group above threshold	Failover	Mark active group as failed	Become active	None.
Interface failure on standby failover group above threshold	No failover	No action	Mark standby group as failed	When the standby failover group is marked as failed, then the active failover group will not attempt to fail over, even if the interface failure threshold is surpassed.

Table 11-2 Failover Behavior for Active/Active Failover (continued)

Failure Event	Policy	Active Group Action	Standby Group Action	Notes
Formerly active failover group recovers	No failover	No action	No action	Unless configured with the preempt command, the failover groups remain active on their current unit.
Failover link failed at startup	No failover	Become active	Become active	If the failover link is down at startup, both failover groups on both units will become active.
Stateful Failover link failed	No failover	No action	No action	State information will become out of date, and sessions will be terminated if a failover occurs.
Failover link failed during operation	No failover	n/a	n/a	Each unit marks the failover interface as failed. You should restore the failover link as soon as possible because the unit cannot fail over to the standby unit while the failover link is down.

Determining Which Type of Failover to Use

The type of failover you choose depends upon your security appliance configuration and how you plan to use the security appliances.

If you are running the security appliance in single mode, then you can only use Active/Standby failover. Active/Active failover is only available to security appliances running in multiple context mode.

If you are running the security appliance in multiple context mode, then you can configure either Active/Active failover or Active/Standby failover.

- To provide load balancing, use Active/Active failover.
- If you do not want to provide load balancing, use Active/Standby or Active/Active failover.

[Table 11-3](#) provides a comparison of some of the features supported by each type of failover configuration:

Table 11-3 Failover Configuration Feature Support

Feature	Active/Active	Active/Standby
Single Context Mode	No	Yes
Multiple Context Mode	Yes	Yes
Load Balancing Network Configurations	Yes	No
Unit Failover	Yes	Yes
Failover of Groups of Contexts	Yes	No
Failover of Individual Contexts	No	No

Regular and Stateful Failover

The security appliance supports two types of failover, regular and stateful. This section includes the following topics:

- [Regular Failover, page 11-14](#)
- [Stateful Failover, page 11-14](#)

Regular Failover

When a failover occurs, all active connections are dropped. Clients need to reestablish connections when the new active unit takes over.

Stateful Failover

When Stateful Failover is enabled, the active unit continually passes per-connection state information to the standby unit. After a failover occurs, the same connection information is available at the new active unit. Supported end-user applications are not required to reconnect to keep the same communication session.

The state information passed to the standby unit includes the following:

- NAT translation table.
- TCP connection states.
- UDP connection states.
- The ARP table.
- The Layer 2 bridge table (when running in transparent firewall mode).
- The HTTP connection states (if HTTP replication is enabled).
- The ISAKMP and IPsec SA table.
- GTP PDP connection database.

The information that is not passed to the standby unit when Stateful Failover is enabled includes the following:

- The HTTP connection table (unless HTTP replication is enabled).
- The user authentication (uauth) table.
- The routing tables. After a failover occurs, some packets may be lost or routed out of the wrong interface (the default route) while the dynamic routing protocols rediscover routes.
- State information for Security Service Modules.

**Note**

If failover occurs during an active Cisco IP SoftPhone session, the call will remain active because the call session state information is replicated to the standby unit. When the call is terminated, the IP SoftPhone client will lose connection with the Call Manager. This occurs because there is no session information for the CTIQBE hangup message on the standby unit. When the IP SoftPhone client does not receive a response back from the Call Manager within a certain time period, it considers the Call Manager unreachable and unregisters itself.

Failover Health Monitoring

The security appliance monitors each unit for overall health and for interface health. See the following sections for more information about how the security appliance performs tests to determine the state of each unit:

- [Unit Health Monitoring, page 11-15](#)
- [Interface Monitoring, page 11-15](#)

Unit Health Monitoring

The security appliance determines the health of the other unit by monitoring the failover link. When a unit does not receive hello messages on the failover link, then the unit sends an ARP request on all interfaces, including the failover interface. The security appliance retries a user-configurable number of times. The action the security appliance takes depends on the response from the other unit. See the following possible actions:

- If the security appliance receives a response on any interface, then it does not fail over.
- If the security appliance does not receive a response on any interface, then the standby unit switches to active mode and classifies the other unit as failed.
- If the security appliance does not receive a response on the failover link only, then the unit does not failover. The failover link is marked as failed. You should restore the failover link as soon as possible because the unit cannot fail over to the standby while the failover link is down.

**Note**

If a failed unit does not recover and you believe it should not be failed, you can reset the state by entering the **failover reset** command. If the failover condition persists, however, the unit will fail again.

Interface Monitoring

You can monitor up to 250 interfaces divided between all contexts. You should monitor important interfaces, for example, you might configure one context to monitor a shared interface (because the interface is shared, all contexts benefit from the monitoring).

When a unit does not receive hello messages on a monitored interface, it runs the following tests:

1. **Link Up/Down test**—A test of the interface status. If the Link Up/Down test indicates that the interface is operational, then the security appliance performs network tests. The purpose of these tests is to generate network traffic to determine which (if either) unit has failed. At the start of each test, each unit clears its received packet count for its interfaces. At the conclusion of each test, each unit looks to see if it has received any traffic. If it has, the interface is considered operational. If one unit receives traffic for a test and the other unit does not, the unit that received no traffic is considered failed. If neither unit has received traffic, then the next test is used.
2. **Network Activity test**—A received network activity test. The unit counts all received packets for up to 5 seconds. If any packets are received at any time during this interval, the interface is considered operational and testing stops. If no traffic is received, the ARP test begins.
3. **ARP test**—A reading of the unit ARP cache for the 2 most recently acquired entries. One at a time, the unit sends ARP requests to these machines, attempting to stimulate network traffic. After each request, the unit counts all received traffic for up to 5 seconds. If traffic is received, the interface is considered operational. If no traffic is received, an ARP request is sent to the next machine. If at the end of the list no traffic has been received, the ping test begins.

4. Broadcast Ping test—A ping test that consists of sending out a broadcast ping request. The unit then counts all received packets for up to 5 seconds. If any packets are received at any time during this interval, the interface is considered operational and testing stops.

If all network tests fail for an interface, but this interface on the other unit continues to successfully pass traffic, then the interface is considered to be failed. If the threshold for failed interfaces is met, then a failover occurs. If the other unit interface also fails all the network tests, then both interfaces go into the “Unknown” state and do not count towards the failover limit.

An interface becomes operational again if it receives any traffic. A failed security appliance returns to standby mode if the interface failure threshold is no longer met.

**Note**

If a failed unit does not recover and you believe it should not be failed, you can reset the state by entering the **failover reset** command. If the failover condition persists, however, the unit will fail again.

Configuring Failover

This section describes how to configure failover and includes the following topics:

- [Configuring Active/Standby Failover, page 11-16](#)
- [Configuring Active/Active Failover, page 11-24](#)
- [Configuring Failover Communication Authentication/Encryption, page 11-35](#)
- [Verifying the Failover Configuration, page 11-35](#)

Configuring Active/Standby Failover

This section provides step-by-step procedures for configuring Active/Standby failover. This section includes the following topics:

- [Prerequisites, page 11-16](#)
- [Configuring Cable-Based Active/Standby Failover \(PIX Security Appliance Only\), page 11-17](#)
- [Configuring LAN-Based Active/Standby Failover, page 11-18](#)
- [Configuring Optional Active/Standby Failover Settings, page 11-21](#)

See the “Failover Configuration Examples” section on page 11-47 for examples of typical failover configurations.

Prerequisites

Before you begin, verify the following:

- Both units have the same hardware, software configuration, and proper license.
- Both units are in the same mode (single or multiple, transparent or routed).

Configuring Cable-Based Active/Standby Failover (PIX Security Appliance Only)

Follow these steps to configure Active/Standby failover using a serial cable as the failover link. The commands in this task are entered on the *primary* unit in the failover pair. The primary unit is the unit that has the end of the cable labeled “Primary” plugged into it. For devices in multiple context mode, the commands are entered in the system execution space unless otherwise noted.

You do not need to bootstrap the secondary unit in the failover pair when you use cable-based failover. Leave the secondary unit powered off until instructed to power it on.

Cable-based failover is only available on the PIX security appliance platform.

To configure cable-based Active/Standby failover, perform the following steps:

-
- Step 1** Connect the Failover cable to the PIX security appliances. Make sure that you attach the end of the cable marked “Primary” to the unit you use as the primary unit, and that you attach the end of the cable marked “Secondary” to the other unit.
- Step 2** Power on the primary unit.
- Step 3** If you have not done so already, configure the active and standby IP addresses for each interface (routed mode) or for the management interface (transparent mode). The standby IP address is used on the security appliance that is currently the standby unit, and it must be in the same subnet as the active IP address. To receive packets from both units in a failover pair, standby IP addresses need to be configured on all interfaces.



Note Do not configure an IP address for the Stateful Failover link if you are going to use a dedicated Stateful Failover interface. You use the **failover interface ip** command to configure a dedicated Stateful Failover interface in a later step.

```
hostname(config-if)# ip address active_addr netmask standby standby_addr
```



Note In multiple context mode, you must configure the interface addresses from within each context. Use the **changeto context** command to switch between contexts. The command prompt changes to `hostname/context(config-if)#`, where *context* is the name of the current context.

- Step 4** (Optional) To enable Stateful Failover, configure the Stateful Failover link.

- a. Specify the interface to be used as the Stateful Failover link:

```
hostname(config)# failover link if_name phy_if
```

The *if_name* argument assigns a logical name to the interface specified by the *phy_if* argument. The *phy_if* argument can be the physical port name, such as Ethernet1, or a previously created subinterface, such as Ethernet0/2.3. This interface should not be used for any other purpose.

- b. Assign an active and standby IP address to the Stateful Failover link:

```
hostname(config)# failover interface ip if_name ip_addr mask standby ip_addr
```



Note If the Stateful Failover link uses a data interface, skip this step. You have already defined the active and standby IP addresses for the interface.

The standby IP address must be in the same subnet as the active IP address. You do not need to identify the standby IP address subnet mask.

The Stateful Failover link IP address and MAC address do not change at failover unless it uses a data interface. The active IP address always stays with the primary unit, while the standby IP address stays with the secondary unit.

- c. Enable the interface:

```
hostname(config)# interface phy_if
hostname(config-if)# no shutdown
```

- Step 5** Enable failover:

```
hostname(config)# failover
```

- Step 6** Power on the secondary unit and enable failover on the unit if it is not already enabled:

```
hostname(config)# failover
```

The active unit sends the configuration in running memory to the standby unit. As the configuration synchronizes, the messages “Beginning configuration replication: sending to mate.” and “End Configuration Replication to mate” appear on the primary console.

- Step 7** Save the configuration to Flash memory on the primary unit. Because the commands entered on the primary unit are replicated to the secondary unit, the secondary unit also saves its configuration to Flash memory.

```
hostname(config)# copy running-config startup-config
```

Configuring LAN-Based Active/Standby Failover

This section describes how to configure Active/Standby failover using an Ethernet failover link. When configuring LAN-based failover, you must bootstrap the secondary device to recognize the failover link before the secondary device can obtain the running configuration from the primary device.



Note

If you are changing from cable-based failover to LAN-based failover, you can skip any steps, such as assigning the active and standby IP addresses for each interface, that you completed for the cable-based failover configuration.

This section includes the following topics:

- [Configuring the Primary Unit, page 11-18](#)
- [Configuring the Secondary Unit, page 11-20](#)

Configuring the Primary Unit

Follow these steps to configure the primary unit in a LAN-based, Active/Standby failover configuration. These steps provide the minimum configuration needed to enable failover on the primary unit. For multiple context mode, all steps are performed in the system execution space unless otherwise noted.

To configure the primary unit in an Active/Standby failover pair, perform the following steps:

- Step 1** If you have not done so already, configure the active and standby IP addresses for each interface (routed mode) or for the management interface (transparent mode). The standby IP address is used on the security appliance that is currently the standby unit, and it must be in the same subnet as the active IP address. To receive packets from both units in a failover pair, standby IP addresses need to be configured on all interfaces.



Note Do not configure an IP address for the Stateful Failover link if you are going to use a dedicated Stateful Failover interface. You use the **failover interface ip** command to configure a dedicated Stateful Failover interface in a later step.

```
hostname(config-if)# ip address active_addr netmask standby standby_addr
```



Note In multiple context mode, you must configure the interface addresses from within each context. Use the **changeto context** command to switch between contexts. The command prompt changes to `hostname/context(config-if)#`, where *context* is the name of the current context.

- Step 2** (PIX security appliance platform only) Enable LAN-based failover.

```
hostname(config)# failover lan enable
```

- Step 3** Designate the unit as the primary unit.

```
hostname(config)# failover lan unit primary
```

- Step 4** Define the failover interface.

- a. Specify the interface to be used as the failover interface.

```
hostname(config)# failover lan interface if_name phy_if
```

The *if_name* argument assigns a name to the interface specified by the *phy_if* argument. The *phy_if* argument can be the physical port name, such as Ethernet1, or a previously created subinterface, such as Ethernet0/2.3.

- b. Assign the active and standby IP address to the failover link.

```
hostname(config)# failover interface ip if_name ip_addr mask standby ip_addr
```

The standby IP address must be in the same subnet as the active IP address. You do not need to identify the standby address subnet mask.

The failover link IP address and MAC address do not change at failover. The active IP address for the failover link always stays with the primary unit, while the standby IP address stays with the secondary unit.

- c. Enable the interface.

```
hostname(config)# interface phy_if
hostname(config-if)# no shutdown
```

Step 5 (Optional) To enable Stateful Failover, configure the Stateful Failover link.

- a. Specify the interface to be used as Stateful Failover link.

```
hostname(config)# failover link if_name phy_if
```



Note If the Stateful Failover link uses the failover link or a data interface, then you only need to supply the *if_name* argument.

The *if_name* argument assigns a logical name to the interface specified by the *phy_if* argument. The *phy_if* argument can be the physical port name, such as Ethernet1, or a previously created subinterface, such as Ethernet0/2.3. This interface should not be used for any other purpose (except, optionally, the failover link).

- b. Assign an active and standby IP address to the Stateful Failover link.



Note If the Stateful Failover link uses the failover link or data interface, skip this step. You have already defined the active and standby IP addresses for the interface.

```
hostname(config)# failover interface ip if_name ip_addr mask standby ip_addr
```

The standby IP address must be in the same subnet as the active IP address. You do not need to identify the standby address subnet mask.

The Stateful Failover link IP address and MAC address do not change at failover unless it uses a data interface. The active IP address always stays with the primary unit, while the standby IP address stays with the secondary unit.

- c. Enable the interface.



Note If the Stateful Failover link uses the failover link or data interface, skip this step. You have already enabled the interface.

```
hostname(config)# interface phy_if
hostname(config-if)# no shutdown
```

Step 6 Enable failover.

```
hostname(config)# failover
```

Step 7 Save the system configuration to Flash memory.

```
hostname(config)# copy running-config startup-config
```

Configuring the Secondary Unit

The only configuration required on the secondary unit is for the failover interface. The secondary unit requires these commands to initially communicate with the primary unit. After the primary unit sends its configuration to the secondary unit, the only permanent difference between the two configurations is the **failover lan unit** command, which identifies each unit as primary or secondary.

For multiple context mode, all steps are performed in the system execution space unless noted otherwise.

To configure the secondary unit, perform the following steps:

Step 1 (PIX security appliance platform only) Enable LAN-based failover.

```
hostname(config)# failover lan enable
```

Step 2 Define the failover interface. Use the same settings as you used for the primary unit.

- a. Specify the interface to be used as the failover interface.

```
hostname(config)# failover lan interface if_name phy_if
```

The *if_name* argument assigns a name to the interface specified by the *phy_if* argument.

- b. Assign the active and standby IP address to the failover link. To receive packets from both units in a failover pair, standby IP addresses need to be configured on all interfaces.

```
hostname(config)# failover interface ip if_name ip_addr mask standby ip_addr
```



Note Enter this command exactly as you entered it on the primary unit when you configured the failover interface on the primary unit.

- c. Enable the interface.

```
hostname(config)# interface phy_if
hostname(config-if)# no shutdown
```

Step 3 (Optional) Designate this unit as the secondary unit.

```
hostname(config)# failover lan unit secondary
```



Note This step is optional because by default units are designated as secondary unless previously configured.

Step 4 Enable failover.

```
hostname(config)# failover
```

After you enable failover, the active unit sends the configuration in running memory to the standby unit. As the configuration synchronizes, the messages “Beginning configuration replication: Sending to mate” and “End Configuration Replication to mate” appear on the active unit console.

Step 5 After the running configuration has completed replication, save the configuration to Flash memory.

```
hostname(config)# copy running-config startup-config
```

Configuring Optional Active/Standby Failover Settings

You can configure the following optional Active/Standby failover setting when you are initially configuring failover or after failover has already been configured. Unless otherwise noted, the commands should be entered on the active unit.

This section includes the following topics:

- [Enabling HTTP Replication with Stateful Failover, page 11-22](#)
- [Disabling and Enabling Interface Monitoring, page 11-22](#)
- [Configuring Interface and Unit Poll Times, page 11-22](#)
- [Configuring Failover Criteria, page 11-23](#)
- [Configuring Virtual MAC Addresses, page 11-23](#)

Enabling HTTP Replication with Stateful Failover

To allow HTTP connections to be included in the state information replication, you need to enable HTTP replication. Because HTTP connections are typically short-lived, and because HTTP clients typically retry failed connection attempts, HTTP connections are not automatically included in the replicated state information.

Enter the following command in global configuration mode to enable HTTP state replication when Stateful Failover is enabled:

```
hostname(config)# failover replication http
```

Disabling and Enabling Interface Monitoring

By default, monitoring of physical interfaces is enabled and monitoring of subinterfaces is disabled. You can monitor up to 250 interfaces on a unit. You can control which interfaces affect your failover policy by disabling the monitoring of specific interfaces and enabling the monitoring of others. This lets you exclude interfaces attached to less critical networks from affecting your failover policy.

For units in multiple configuration mode, use the following commands to enable or disable health monitoring for specific interfaces:

- To disable health monitoring for an interface, enter the following command within a context:

```
hostname/context(config)# no monitor-interface if_name
```

- To enable health monitoring for an interface, enter the following command within a context:

```
hostname/context(config)# monitor-interface if_name
```

For units in single configuration mode, use the following commands to enable or disable health monitoring for specific interfaces:

- To disable health monitoring for an interface, enter the following command in global configuration mode:

```
hostname(config)# no monitor-interface if_name
```

- To enable health monitoring for an interface, enter the following command in global configuration mode:

```
hostname(config)# monitor-interface if_name
```

Configuring Interface and Unit Poll Times

The security appliance monitors both unit and interface health for failover. You can configure the amount of time between hello messages when monitoring interface and unit health. Decreasing the poll time allows an interface or unit failure to be detected more quickly, but consumes more system resources.

To change the interface poll time, enter the following command in global configuration mode:

```
hostname(config)# failover polltime interface seconds
```

To change the unit poll time, enter the following command in global configuration mode:

```
hostname(config)# failover polltime seconds
```

Configuring Failover Criteria

By default, a single interface failure causes failover. You can specify a specific number of interfaces or a percentage of monitored interfaces that must fail before a failover occurs.

To change the default failover criteria, enter the following command in global configuration mode:

```
hostname(config)# failover interface-policy num[%]
```

When specifying a specific number of interfaces, the *num* argument can be from 1 to 250. When specifying a percentage of interfaces, the *num* argument can be from 1 to 100.

Configuring Virtual MAC Addresses

In Active/Standby failover, the MAC addresses for the primary unit are always associated with the active IP addresses. If the secondary unit boots first and becomes active, it uses the burned-in MAC address for its interfaces. When the primary unit comes online, the secondary unit obtains the MAC addresses from the primary unit. The change can disrupt network traffic.

You can configure virtual MAC addresses for each interface to ensure that the secondary unit uses the correct MAC addresses when it is the active unit, even if it comes online before the primary unit. If you do not specify virtual MAC addresses, then the failover pair uses the burned-in NIC address as the MAC address.



Note

You cannot configure a virtual MAC address for the failover or Stateful Failover links. The MAC and IP addresses for those links do not change during failover.

Enter the following command on the active unit to configure the virtual MAC addresses for an interface:

```
hostname(config)# failover mac address phy_if active_mac standby_mac
```

The *phy_if* argument is the physical name of the interface, such as Ethernet1. The *active_mac* and *standby_mac* arguments are MAC addresses in H.H.H format, where H is a 16-bit hexadecimal digit. For example, the MAC address 00-0C-F1-42-4C-DE would be entered as 000C.F142.4CDE.

The *active_mac* address is associated with the active IP address for the interface, and the *standby_mac* is associated with the standby IP address for the interface.

Configuring Active/Active Failover

This section describes how to configure Active/Active failover.

This section includes the following topics:

- [Prerequisites, page 11-24](#)
- [Configuring Cable-Based Active/Active Failover \(PIX security appliance Only\), page 11-24](#)
- [Configuring LAN-Based Active/Active Failover, page 11-26](#)
- [Configuring Optional Active/Active Failover Settings, page 11-29](#)

See the “[Failover Configuration Examples](#)” section on [page 11-47](#) for examples of typical failover configurations.

Prerequisites

Before you begin, verify the following:

- Both units have the same hardware, software configuration, and proper license.
- Both units are in multiple context mode.

Configuring Cable-Based Active/Active Failover (PIX security appliance Only)

Follow these steps to configure Active/Active failover using a serial cable as the failover link. The commands in this task are entered on the *primary* unit in the failover pair. The primary unit is the unit that has the end of the cable labeled “Primary” plugged into it. For devices in multiple context mode, the commands are entered in the system execution space unless otherwise noted.

You do not need to bootstrap the secondary unit in the failover pair when you use cable-based failover. Leave the secondary unit powered off until instructed to power it on.

Cable-based failover is only available on the PIX security appliance platform.

To configure cable-based, Active/Active failover, perform the following steps:

-
- Step 1** Connect the failover cable to the PIX security appliances. Make sure that you attach the end of the cable marked “Primary” to the unit you use as the primary unit, and that you attach the end of the cable marked “Secondary” to the unit you use as the secondary unit.
- Step 2** Power on the primary unit.
- Step 3** If you have not done so already, configure the active and standby IP addresses for each interface (routed mode) or for the management interface (transparent mode). The standby IP address is used on the security appliance that is currently the standby unit, and it must be in the same subnet as the active IP address.



Note Do not configure an IP address for the Stateful Failover link if you are going to use a dedicated Stateful Failover interface. You use the **failover interface ip** command to configure a dedicated Stateful Failover interface in a later step.

```
hostname(config-if)# ip address active_addr netmask standby standby_addr
```



Note In multiple context mode, you must configure the interface addresses from within each context. Use the **changeto context** command to switch between contexts. The command prompt changes to `hostname/context(config-if)#`, where *context* is the name of the current context.

Step 4 (Optional) To enable Stateful Failover, configure the Stateful Failover link.

- a. Specify the interface to be used as Stateful Failover link.

```
hostname(config)# failover link if_name phy_if
```

The *if_name* argument assigns a logical name to the interface specified by the *phy_if* argument. The *phy_if* argument can be the physical port name, such as Ethernet1, or a previously created subinterface, such as Ethernet0/2.3. This interface should not be used for any other purpose (except, optionally, the failover link).

- b. Assign an active and standby IP address to the Stateful Failover link.

```
hostname(config)# failover interface ip if_name ip_addr mask standby ip_addr
```

The standby IP address must be in the same subnet as the active IP address. You do not need to identify the standby IP address subnet mask.

The Stateful Failover link IP address and MAC address do not change at failover except for when Stateful Failover uses a regular data interface. The active IP address always stays with the primary unit, while the standby IP address stays with the secondary unit.

- c. Enable the interface.

```
hostname(config)# interface phy_if
hostname(config-if)# no shutdown
```

Step 5 Configure the failover groups. You can have at most two failover groups. The **failover group** command creates the specified failover group if it does not exist and enters the failover group configuration mode.

For each failover group, you need to specify whether the failover group has primary or secondary preference using the **primary** or **secondary** command. You can assign the same preference to both failover groups. For load balancing configurations, you should assign each failover group a different unit preference.

The following example assigns failover group 1 a primary preference and failover group 2 a secondary preference:

```
hostname(config)# failover group 1
hostname(config-fover-group)# primary
hostname(config-fover-group)# exit
hostname(config)# failover group 2
hostname(config-fover-group)# secondary
hostname(config-fover-group)# exit
```

Step 6 Assign each user context to a failover group using the **join-failover-group** command in context configuration mode.

Any unassigned contexts are automatically assigned to failover group 1. The admin context is always a member of failover group 1.

Enter the following commands to assign each context to a failover group:

```
hostname(config)# context context_name
hostname(config-context)# join-failover-group {1 | 2}
hostname(config-context)# exit
```

Step 7 Enable failover.

```
hostname(config)# failover
```

Step 8 Power on the secondary unit and enable failover on the unit if it is not already enabled:

```
hostname(config)# failover
```

The active unit sends the configuration in running memory to the standby unit. As the configuration synchronizes, the messages “Beginning configuration replication: Sending to mate” and “End Configuration Replication to mate” appear on the primary console.

Step 9 Save the configuration to Flash memory on the Primary unit. Because the commands entered on the primary unit are replicated to the secondary unit, the secondary unit also saves its configuration to Flash memory.

```
hostname(config)# copy running-config startup-config
```

Step 10 If necessary, force any failover group that is active on the primary to the active state on the secondary. To force a failover group to become active on the secondary unit, issue the following command in the system execution space on the primary unit:

```
hostname# no failover active group group_id
```

The *group_id* argument specifies the group you want to become active on the secondary unit.

Configuring LAN-Based Active/Active Failover

This section describes how to configure Active/Active failover using an Ethernet failover link. When configuring LAN-based failover, you must bootstrap the secondary device to recognize the failover link before the secondary device can obtain the running configuration from the primary device.

This section includes the following topics:

- [Configure the Primary Unit, page 11-26](#)
- [Configure the Secondary Unit, page 11-28](#)

Configure the Primary Unit

To configure the primary unit in an Active/Active failover configuration, perform the following steps:

Step 1 Configure the basic failover parameters in the system execution space.

- a. (PIX security appliance platform only) Enable LAN-based failover.

```
hostname(config)# hostname(config)# failover lan enable
```

- b. Designate the unit as the primary unit.

```
hostname(config)# failover lan unit primary
```

- c. Specify the failover link.

```
hostname(config)# failover lan interface if_name phy_if
```

The *if_name* argument assigns a logical name to the interface specified by the *phy_if* argument. The *phy_if* argument can be the physical port name, such as Ethernet1, or a previously created subinterface, such as Ethernet0/2.3. This interface should not be used for any other purpose (except, optionally, the Stateful Failover link).

- d. Specify the failover link active and standby IP addresses. To receive packets from both units in a failover pair, standby IP addresses need to be configured on all interfaces.

```
hostname(config)# failover interface ip if_name ip_addr mask standby ip_addr
```

The standby IP address must be in the same subnet as the active IP address. You do not need to identify the standby IP address subnet mask. The failover link IP address and MAC address do not change at failover. The active IP address always stays with the primary unit, while the standby IP address stays with the secondary unit.

Step 2 (Optional) To enable Stateful Failover, configure the Stateful Failover link.

- a. Specify the interface to be used as Stateful Failover link.

```
hostname(config)# failover link if_name phy_if
```

The *if_name* argument assigns a logical name to the interface specified by the *phy_if* argument. The *phy_if* argument can be the physical port name, such as Ethernet1, or a previously created subinterface, such as Ethernet0/2.3. This interface should not be used for any other purpose (except, optionally, the failover link).



Note If the Stateful Failover link uses the failover link or a regular data interface, then you only need to supply the *if_name* argument.

- b. Assign an active and standby IP address to the Stateful Failover link.



Note If the Stateful Failover link uses the failover link or a regular data interface, skip this step. You have already defined the active and standby IP addresses for the interface.

```
hostname(config)# failover interface ip if_name ip_addr mask standby ip_addr
```

The standby IP address must be in the same subnet as the active IP address. You do not need to identify the standby address subnet mask.

The state link IP address and MAC address do not change at failover. The active IP address always stays with the primary unit, while the standby IP address stays with the secondary unit.

- c. Enable the interface.



Note If the Stateful Failover link uses the failover link or regular data interface, skip this step. You have already enabled the interface.

```
hostname(config)# interface phy_if
hostname(config-if)# no shutdown
```

Step 3 Configure the failover groups. You can have at most two failover groups. The **failover group** command creates the specified failover group if it does not exist and enters the failover group configuration mode.

For each failover group, you need to specify whether the failover group has primary or secondary preference using the **primary** or **secondary** command. You can assign the same preference to both failover groups. For load balancing configurations, you should assign each failover group a different unit preference.

The following example assigns failover group 1 a primary preference and failover group 2 a secondary preference:

```
hostname(config)# failover group 1
hostname(config-fover-group)# primary
hostname(config-fover-group)# exit
hostname(config)# failover group 2
hostname(config-fover-group)# secondary
hostname(config-fover-group)# exit
```

- Step 4** Assign each user context to a failover group using the **join-failover-group** command in context configuration mode.

Any unassigned contexts are automatically assigned to failover group 1. The admin context is always a member of failover group 1.

Enter the following commands to assign each context to a failover group:

```
hostname(config)# context context_name
hostname(config-context)# join-failover-group {1 | 2}
hostname(config-context)# exit
```

- Step 5** Enable failover.

```
hostname(config)# failover
```

Configure the Secondary Unit

When configuring LAN-based Active/Active failover, you need to bootstrap the secondary unit to recognize the failover link. This allows the secondary unit to communicate with and receive the running configuration from the primary unit.

To bootstrap the secondary unit in an Active/Active failover configuration, perform the following steps:

- Step 1** (PIX security appliance platform only) Enable LAN-based failover.

```
hostname(config)# failover lan enable
```

- Step 2** Define the failover interface. Use the same settings as you used for the primary unit.

- a. Specify the interface to be used as the failover interface.

```
hostname(config)# failover lan interface if_name phy_if
```

The *if_name* argument assigns a logical name to the interface specified by the *phy_if* argument. The *phy_if* argument can be the physical port name, such as Ethernet1, or a previously created subinterface, such as Ethernet0/2.3.

- b. Assign the active and standby IP address to the failover link. To receive packets from both units in a failover pair, standby IP addresses need to be configured on all interfaces.

```
hostname(config)# failover interface ip if_name ip_addr mask standby ip_addr
```



Note Enter this command exactly as you entered it on the primary unit when you configured the failover interface.

The standby IP address must be in the same subnet as the active IP address. You do not need to identify the standby address subnet mask.

- c. Enable the interface.

```
hostname(config)# interface phy_if
hostname(config-if)# no shutdown
```

- Step 3** (Optional) Designate this unit as the secondary unit.

```
hostname(config)# failover lan unit secondary
```



Note This step is optional because by default units are designated as secondary unless previously configured otherwise.

- Step 4** Enable failover.

```
hostname(config)# failover
```

After you enable failover, the active unit sends the configuration in running memory to the standby unit. As the configuration synchronizes, the messages `Beginning configuration replication: Sending to mate` and `End Configuration Replication to mate` appear on the active unit console.

- Step 5** After the running configuration has completed replication, enter the following command to save the configuration to Flash memory:

```
hostname(config)# copy running-config startup-config
```

- Step 6** If necessary, force any failover group that is active on the primary to the active state on the secondary unit. To force a failover group to become active on the secondary unit, enter the following command in the system execution space on the primary unit:

```
hostname# no failover active group group_id
```

The `group_id` argument specifies the group you want to become active on the secondary unit.

Configuring Optional Active/Active Failover Settings

The following optional Active/Active failover settings can be configured when you are initially configuring failover or after you have already established failover. Unless otherwise noted, the commands should be entered on the unit that has failover group 1 in the active state.

This section includes the following topics:

- [Configuring Failover Group Preemption, page 11-30](#)
- [Enabling HTTP Replication with Stateful Failover, page 11-30](#)
- [Disabling and Enabling Interface Monitoring, page 11-30](#)
- [Configuring Interface and Unit Poll Times, page 11-30](#)
- [Configuring Failover Criteria, page 11-31](#)
- [Configuring Virtual MAC Addresses, page 11-31](#)
- [Configuring Asymmetric Routing Support, page 11-31](#)

Configuring Failover Group Preemption

Assigning a primary or secondary priority to a failover group specifies which unit the failover group becomes active on when both units boot simultaneously. However, if one unit boots before the other, then both failover groups become active on that unit. When the other unit comes online, any failover groups that have the unit as a priority do not become active on that unit unless manually forced over, a failover occurs, or the failover group is configured with the **preempt** command. The **preempt** command causes a failover group to become active on the designated unit automatically when that unit becomes available.

Enter the following commands to configure preemption for the specified failover group:

```
hostname(config)# failover group {1 | 2}
hostname(config-fover-group)# preempt [delay]
```

You can enter an optional *delay* value, which specifies the number of seconds the failover group remains active on the current unit before automatically becoming active on the designated unit.

Enabling HTTP Replication with Stateful Failover

To allow HTTP connections to be included in the state information, you need to enable HTTP replication. Because HTTP connections are typically short-lived, and because HTTP clients typically retry failed connection attempts, HTTP connections are not automatically included in the replicated state information. You can use the **replication http** command to cause a failover group to replicate HTTP state information when Stateful Failover is enabled.

To enable HTTP state replication for a failover group, enter the following command. This command only affects the failover group in which it was configured. To enable HTTP state replication for both failover groups, you must enter this command in each group. This command should be entered in the system execution space.

```
hostname(config)# failover group {1 | 2}
hostname(config-fover-group)# replication http
```

Disabling and Enabling Interface Monitoring

You can monitor up to 250 interfaces on a unit. By default, monitoring of physical interfaces is enabled and the monitoring of subinterfaces is disabled. You can control which interfaces affect your failover policy by disabling the monitoring of specific interfaces and enabling the monitoring of others. This lets you exclude interfaces attached to less critical networks from affecting your failover policy.

To disable health monitoring on an interface, enter the following command within a context:

```
hostname/context(config)# no monitor-interface if_name
```

To enable health monitoring on an interface, enter the following command within a context:

```
hostname/context(config)# monitor-interface if_name
```

Configuring Interface and Unit Poll Times

You can configure the amount of time between hello messages when monitoring the health of the interfaces in a failover group. Decreasing the interface poll time allows failover to occur faster when an interface fails, but consumes more system resources.

To change the default interface poll time, enter the following commands:

```
hostname(config)# failover group {1 | 2}
hostname(config-fover-group)# polltime interface seconds
```

The unit poll time specifies the amount of time between hello messages sent across the failover link to determine the health of the peer unit. Decreasing the unit poll time allows a failed unit to be detected faster, but consumes more system resources. To change the unit poll time, enter the following command in global configuration mode of the system execution space:

```
hostname(config)# failover polltime seconds
```

Configuring Failover Criteria

By default, if a single interface fails failover occurs. You can specify a specific number of interfaces or a percentage of monitored interfaces that must fail before a failover occurs. The failover criteria is specified on a failover group basis.

To change the default failover criteria for the specified failover group, enter the following commands:

```
hostname(config)# failover group {1 | 2}
hostname(config-fover-group)# interface-policy num[%]
```

When specifying a specific number of interfaces, the *num* argument can be from 1 to 250. When specifying a percentage of interfaces, the *num* argument can be from 1 to 100.

Configuring Virtual MAC Addresses

Active/Active failover uses virtual MAC addresses on all interfaces. If you do not specify the virtual MAC addresses, then they are computed as follows:

- Active unit default MAC address: 00a0.c9physical_port_number.failover_group_id01.
- Standby unit default MAC address: 00a0.c9physical_port_number.failover_group_id02.



Note

If you have more than one Active/Active failover pair on the same network, it is possible to have the same default virtual MAC addresses assigned to the interfaces on one pair as are assigned to the interfaces of the other pairs because of the way the default virtual MAC addresses are determined. To avoid having duplicate MAC addresses on your network, make sure you assign each physical interface a virtual active and standby MAC address for all failover groups.

You can configure specific active and standby MAC addresses for an interface by entering the following commands:

```
hostname(config)# failover group {1 | 2}
hostname(config-fover-group)# mac address phy_if active_mac standby_mac
```

The *phy_if* argument is the physical name of the interface, such as Ethernet1. The *active_mac* and *standby_mac* arguments are MAC addresses in H.H.H format, where H is a 16-bit hexadecimal digit. For example, the MAC address 00-0C-F1-42-4C-DE would be entered as 000C.F142.4CDE.

The *active_mac* address is associated with the active IP address for the interface, and the *standby_mac* is associated with the standby IP address for the interface.

Configuring Asymmetric Routing Support

When running in Active/Active failover, a unit may receive a return packet for a connection that originated through its peer unit. Because the security appliance that receives the packet does not have any connection information for the packet, the packet is dropped. This most commonly occurs when the two security appliances in an Active/Active failover pair are connected to different service providers and the outbound connection does not use a NAT address.

You can prevent the return packets from being dropped using the **asr-group** command on interfaces where this is likely to occur. When an interface configured with the **asr-group** command receives a packet for which it has no session information, it checks the session information for the other interfaces that are in the same group. If it does not find a match, the packet is dropped. If it finds a match, then one of the following actions occurs:

- If the incoming traffic originated on a peer unit, some or all of the layer 2 header is rewritten and the packet is redirected to the other unit. This redirection continues as long as the session is active.
- If the incoming traffic originated on a different interface on the same unit, some or all of the layer 2 header is rewritten and the packet is reinjected into the stream.

**Note**

Using the **asr-group** command to configure asymmetric routing support is more secure than using the **static** command with the **nailed** option.

The **asr-group** command does not provide asymmetric routing; it restores asymmetrically routed packets to the correct interface.

Prerequisites

You must have the following configured for asymmetric routing support to function properly:

- Active/Active Failover
- Stateful Failover—passes state information for sessions on interfaces in the active failover group to the standby failover group.
- **replication http**—HTTP session state information is not passed to the standby failover group, and therefore is not present on the standby interface. For the security appliance to be able re-route asymmetrically routed HTTP packets, you need to replicate the HTTP state information.

You can configure the **asr-group** command on an interface without having failover configured, but it does not have any effect until Stateful Failover is enabled.

Configuring Support for Asymmetrically Routed Packets

To configure support for asymmetrically routed packets, perform the following steps:

Step 1 Configure Active/Active Stateful Failover for the failover pair. See [Configuring Active/Active Failover, page 11-24](#).

Step 2 For each interface that you want to participate in asymmetric routing support enter the following command. You must enter the command on the unit where the context is in the active state so that the command is replicated to the standby failover group. For more information about command replication, see [Command Replication, page 11-11](#).

```
hostname/ctx(config)# interface phy_if
hostname/ctx(config-if)# asr-group num
```

Valid values for *num* range from 1 to 32. You need to enter the command for each interface that participates in the asymmetric routing group. You can view the number of ASR packets transmitted, received, or dropped by an interface using the **show interface detail** command. You can have more than one ASR group configured on the security appliance, but only one per interface. Only members of the same ASR group are checked for session information.

Example

Figure 11-1 shows an example of using the **asr-group** command for asymmetric routing support.

Figure 11-1 ASR Example

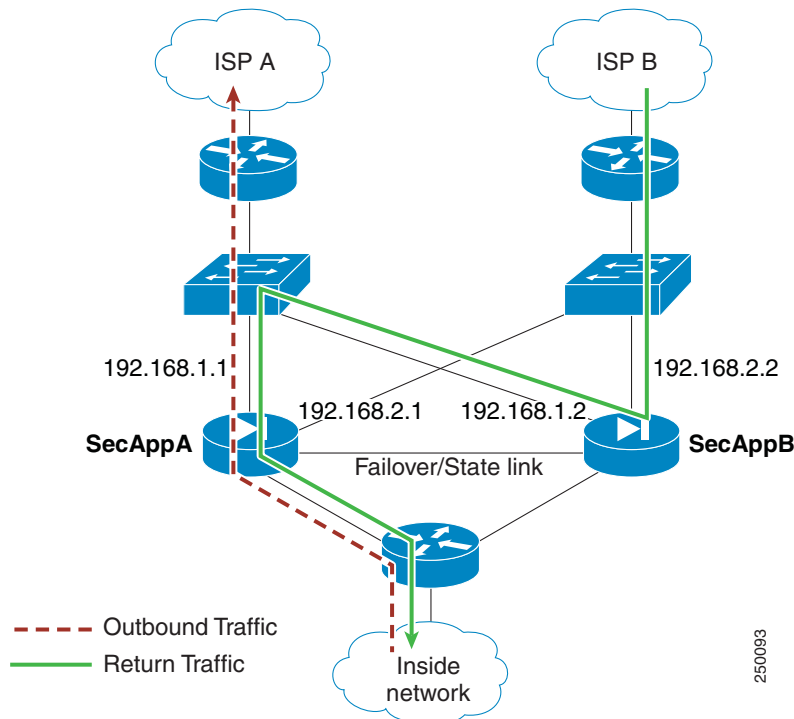

The two units have the following configuration (configurations show only the relevant commands). The device labeled SecAppA in the diagram is the primary unit in the failover pair.

Example 11-1 Primary Unit System Configuration

```
hostname primary
interface GigabitEthernet0/1
description LAN/STATE Failover Interface
interface GigabitEthernet0/2
no shutdown
interface GigabitEthernet0/3
no shutdown
interface GigabitEthernet0/4
no shutdown
interface GigabitEthernet0/5
no shutdown
failover
failover lan unit primary
failover lan interface folink GigabitEthernet0/1
failover link folink
failover interface ip folink 10.0.4.1 255.255.255.0 standby 10.0.4.11
failover group 1
primary
failover group 2
secondary
admin-context admin
context admin
description admin
```

```

allocate-interface GigabitEthernet0/2
allocate-interface GigabitEthernet0/3
config-url flash:/admin.cfg
join-failover-group 1
context ctx1
description context 1
allocate-interface GigabitEthernet0/4
allocate-interface GigabitEthernet0/5
config-url flash:/ctx1.cfg
join-failover-group 2

```

Example 11-2 admin Context Configuration

```

hostname SecAppA
interface GigabitEthernet0/2
nameif outsideISP-A
security-level 0
ip address 192.168.1.1 255.255.255.0 standby 192.168.1.2
asr-group 1
interface GigabitEthernet0/3
nameif inside
security-level 100
ip address 10.1.0.1 255.255.255.0 standby 10.1.0.11
monitor-interface outside

```

Example 11-3 ctx1 Context Configuration

```

hostname SecAppB
interface GigabitEthernet0/4
nameif outsideISP-B
security-level 0
ip address 192.168.2.2 255.255.255.0 standby 192.168.2.1
asr-group 1
interface GigabitEthernet0/5
nameif inside
security-level 100
ip address 10.2.20.1 255.255.255.0 standby 10.2.20.11

```

Figure 11-1 on page 11-33 shows the ASR support working as follows:

1. An outbound session passes through security appliance SecAppA. It exits interface outsideISP-A (192.168.1.1).
2. Because of asymmetric routing configured somewhere upstream, the return traffic comes back through the interface outsideISP-B (192.168.2.2) on security appliance SecAppB.
3. Normally the return traffic would be dropped because there is no session information for the traffic on interface 192.168.2.2. However, the interface is configured with the command **asr-group 1**. The unit looks for the session on any other interface configured with the same ASR group ID.
4. The session information is found on interface outsideISP-A (192.168.1.2), which is in the standby state on the unit SecAppB. Stateful Failover replicated the session information from SecAppA to SecAppB.
5. Instead of being dropped, the layer 2 header is re-written with information for interface 192.168.1.1 and the traffic is redirected out of the interface 192.168.1.2, where it can then return through the interface on the unit from which it originated (192.168.1.1 on SecAppA). This forwarding continues as needed until the session ends.

Configuring Failover Communication Authentication/Encryption

You can encrypt and authenticate the communication between failover peers by specifying a shared secret or hexadecimal key.

**Note**

On the PIX security appliance platform, if you are using the dedicated serial failover cable to connect the units, then communication over the failover link is not encrypted even if a failover key is configured. The failover key only encrypts LAN-based failover communication.

**Caution**

All information sent over the failover and Stateful Failover links is sent in clear text unless you secure the communication with a failover key. If the security appliance is used to terminate VPN tunnels, this information includes any usernames, passwords and preshared keys used for establishing the tunnels. Transmitting this sensitive data in clear text could pose a significant security risk. We recommend securing the failover communication with a failover key if you are using the security appliance to terminate VPN tunnels.

Enter the following command on the active unit of an Active/Standby failover pair or on the unit that has failover group 1 in the active state of an Active/Active failover pair:

```
hostname(config)# failover key {secret | hex key}
```

The *secret* argument specifies a shared secret that is used to generate the encryption key. It can be from 1 to 63 characters. The characters can be any combination of numbers, letters, or punctuation. The *hex key* argument specifies a hexadecimal encryption key. The key must be 32 hexadecimal characters (0-9, a-f).

**Note**

To prevent the failover key from being replicated to the peer unit in clear text for an existing failover configuration, disable failover on the active unit (or in the system execution space on the unit that has failover group 1 in the active state), enter the failover key on both units, and then re-enable failover. When failover is re-enabled, the failover communication will be encrypted with the key.

For new LAN-based failover configurations, the **failover key** command should be part of the failover pair bootstrap configuration.

Verifying the Failover Configuration

This section describes how to verify your failover configuration. This section includes the following topics:

- [Using the show failover Command, page 11-36](#)
- [Viewing Monitored Interfaces, page 11-44](#)
- [Displaying the Failover Commands in the Running Configuration, page 11-44](#)
- [Testing the Failover Functionality, page 11-44](#)

Using the show failover Command

This section describes the **show failover** command output. On each unit you can verify the failover status by entering the **show failover** command. The information displayed depends upon whether you are using Active/Standby or Active/Active failover.

This section includes the following topics:

- [show failover—Active/Standby, page 11-36](#)
- [Show Failover—Active/Active, page 11-40](#)

show failover—Active/Standby

The following is sample output from the **show failover** command for Active/Standby Failover. [Table 11-4](#) provides descriptions for the information shown.

```
hostname# show failover

Failover On
Cable status: N/A - LAN-based failover enabled
Failover unit Primary
Failover LAN Interface: fover Ethernet2 (up)
Unit Poll frequency 1 seconds, holdtime 3 seconds
Interface Poll frequency 15 seconds
Interface Policy 1
Monitored Interfaces 2 of 250 maximum
failover replication http
Last Failover at: 22:44:03 UTC Dec 8 2004
  This host: Primary - Active
    Active time: 13434 (sec)
    Interface inside (10.130.9.3): Normal
    Interface outside (10.132.9.3): Normal
  Other host: Secondary - Standby Ready
    Active time: 0 (sec)
    Interface inside (10.130.9.4): Normal
    Interface outside (10.132.9.4): Normal

Stateful Failover Logical Update Statistics
Link : fover Ethernet2 (up)
Stateful Obj   xmit      xerr      rcv       rerr
General        1950       0         1733      0
sys cmd        1733       0         1733      0
up time         0           0          0         0
RPC services   0           0          0         0
TCP conn        6           0          0         0
UDP conn        0           0          0         0
ARP tbl        106         0          0         0
Xlate_Timeout  0           0          0         0
VPN IKE upd    15           0          0         0
VPN IPSEC upd  90           0          0         0
VPN CTCP upd   0           0          0         0
VPN SDI upd    0           0          0         0
VPN DHCP upd   0           0          0         0

Logical Update Queue Information
                Cur      Max      Total
Recv Q:         0        2        1733
Xmit Q:         0        2       15225
```

In multiple context mode, using the **show failover** command in a security context displays the failover information for that context. The information is similar to the information shown when using the command in single context mode. Instead of showing the active/standby status of the unit, it displays the active/standby status of the context. Table 11-4 provides descriptions for the information shown.

```
Failover On
Last Failover at: 04:03:11 UTC Jan 4 2003
  This context: Negotiation
    Active time: 1222 (sec)
    Interface outside (192.168.5.121): Normal
    Interface inside (192.168.0.1): Normal
  Peer context: Not Detected
    Active time: 0 (sec)
    Interface outside (192.168.5.131): Normal
    Interface inside (192.168.0.11): Normal

Stateful Failover Logical Update Statistics
Status: Configured.
Stateful Obj   xmit   xerr   rcv    rerr
RPC services   0       0     0      0
TCP conn      99      0     0      0
UDP conn       0       0     0      0
ARP tbl       22      0     0      0
Xlate_Timeout  0       0     0      0
GTP PDP       0       0     0      0
GTP PDPMCB    0       0     0      0
```

Table 11-4 Show Failover Display Description

Field	Options
Failover	<ul style="list-style-type: none"> On Off
Cable status:	<ul style="list-style-type: none"> Normal—The cable is connected to both units, and they both have power. My side not connected—The serial cable is not connected to this unit. It is unknown if the cable is connected to the other unit. Other side is not connected—The serial cable is connected to this unit, but not to the other unit. Other side powered off—The other unit is turned off. N/A—LAN-based failover is enabled.
Failover Unit	Primary or Secondary.
Failover LAN Interface	Displays the logical and physical name of the failover link.
Unit Poll frequency	Displays the number of seconds between hello messages sent to the peer unit and the number of seconds during which the unit must receive a hello message on the failover link before declaring the peer failed.
Interface Poll frequency	<p><i>n</i> seconds</p> <p>The number of seconds you set with the failover polltime interface command. The default is 15 seconds.</p>
Interface Policy	Displays the number or percentage of interfaces that must fail to trigger failover.

Table 11-4 Show Failover Display Description (continued)

Field	Options
Monitored Interfaces	Displays the number of interfaces monitored out of the maximum possible.
failover replication http	Displays if HTTP state replication is enabled for Stateful Failover.
Last Failover at:	The date and time of the last failover in the following form: <i>hh:mm:ss UTC DayName Month Day yyyy</i> UTC (Coordinated Universal Time) is equivalent to GMT (Greenwich Mean Time).
This host: Other host:	For each host, the display shows the following information.
Primary or Secondary	<ul style="list-style-type: none"> • Active • Standby
Active time:	<i>n</i> (sec) The amount of time the unit has been active. This time is cumulative, so the standby unit, if it was active in the past, will also show a value.
slot <i>x</i>	Information about the module in the slot or empty.
Interface <i>name</i> (<i>n.n.n.n</i>):	For each interface, the display shows the IP address currently being used on each unit, as well as one of the following conditions: <ul style="list-style-type: none"> • Failed—The interface has failed. • No Link—The interface line protocol is down. • Normal—The interface is working correctly. • Link Down—The interface has been administratively shut down. • Unknown—The security appliance cannot determine the status of the interface. • Waiting—Monitoring of the network interface on the other unit has not yet started.
Stateful Failover Logical Update Statistics	The following fields relate to the Stateful Failover feature. If the Link field shows an interface name, the Stateful Failover statistics are shown.
Link	<ul style="list-style-type: none"> • <i>interface_name</i>—The interface used for the Stateful Failover link. • Unconfigured—You are not using Stateful Failover. • up—The interface is up and functioning. • down—The interface is either administratively shutdown or is physically down. • failed—The interface has failed and is not passing stateful data.

Table 11-4 Show Failover Display Description (continued)

Field	Options
Stateful Obj	<p>For each field type, the following statistics are shown. They are counters for the number of state information packets sent between the two units; the fields do not necessarily show active connections through the unit.</p> <ul style="list-style-type: none"> • xmit—Number of transmitted packets to the other unit. • xerr—Number of errors that occurred while transmitting packets to the other unit. • rcv—Number of received packets. • rerr—Number of errors that occurred while receiving packets from the other unit.
General	Sum of all stateful objects.
sys cmd	Logical update system commands; for example, LOGIN and Stay Alive.
up time	Up time, which the active unit passes to the standby unit.
RPC services	Remote Procedure Call connection information.
TCP conn	TCP connection information.
UDP conn	Dynamic UDP connection information.
ARP tbl	Dynamic ARP table information.
L2BRIDGE tbl	Layer 2 bridge table information (transparent firewall mode only).
Xlate_Timeout	Indicates connection translation timeout information.
VPN IKE upd	IKE connection information.
VPN IPSEC upd	IPSec connection information.
VPN CTCP upd	cTCP tunnel connection information.
VPN SDI upd	SDI AAA connection information.
VPN DHCP upd	Tunneled DHCP connection information.
GTP PDP	GTP PDP update information. This information appears only if inspect GTP is enabled.
GTP PDPMCB	GTP PDPMCB update information. This information appears only if inspect GTP is enabled.
Logical Update Queue Information	<p>For each field type, the following statistics are used:</p> <ul style="list-style-type: none"> • Cur—Current number of packets • Max—Maximum number of packets • Total—Total number of packets
Recv Q	The status of the receive queue.
Xmit Q	The status of the transmit queue.

Show Failover—Active/Active

The following is sample output from the **show failover** command for Active/Active Failover. [Table 11-5](#) provides descriptions for the information shown.

```

hostname# show failover

Failover On
Failover unit Primary
Failover LAN Interface: third GigabitEthernet0/2 (up)
Unit Poll frequency 1 seconds, holdtime 15 seconds
Interface Poll frequency 4 seconds
Interface Policy 1
Monitored Interfaces 8 of 250 maximum
failover replication http
Group 1 last failover at: 13:40:18 UTC Dec 9 2004
Group 2 last failover at: 13:40:06 UTC Dec 9 2004

This host:      Primary
Group 1        State:          Active
                Active time:    2896 (sec)
Group 2        State:          Standby Ready
                Active time:    0 (sec)

slot 0: ASA-5530 hw/sw rev (1.0/7.0(0)79) status (Up Sys)
slot 1: SSM-IDS-20 hw/sw rev (1.0/5.0(0.11)S91(0.11)) status (Up)
admin Interface outside (10.132.8.5): Normal
admin Interface third (10.132.9.5): Normal
admin Interface inside (10.130.8.5): Normal
admin Interface fourth (10.130.9.5): Normal
ctx1 Interface outside (10.1.1.1): Normal
ctx1 Interface inside (10.2.2.1): Normal
ctx2 Interface outside (10.3.3.2): Normal
ctx2 Interface inside (10.4.4.2): Normal

Other host:    Secondary
Group 1        State:          Standby Ready
                Active time:    190 (sec)
Group 2        State:          Active
                Active time:    3322 (sec)

slot 0: ASA-5530 hw/sw rev (1.0/7.0(0)79) status (Up Sys)
slot 1: SSM-IDS-20 hw/sw rev (1.0/5.0(0.1)S91(0.1)) status (Up)
admin Interface outside (10.132.8.6): Normal
admin Interface third (10.132.9.6): Normal
admin Interface inside (10.130.8.6): Normal
admin Interface fourth (10.130.9.6): Normal
ctx1 Interface outside (10.1.1.2): Normal
ctx1 Interface inside (10.2.2.2): Normal
ctx2 Interface outside (10.3.3.1): Normal
ctx2 Interface inside (10.4.4.1): Normal

Stateful Failover Logical Update Statistics
Link : third GigabitEthernet0/2 (up)
Stateful Obj   xmit      xerr      rcv       rerr
General        1973      0         1895      0
sys cmd        380       0         380       0
up time        0         0         0         0
RPC services   0         0         0         0
TCP conn       1435     0         1450     0
UDP conn       0         0         0         0
ARP tbl        124      0         65       0
Xlate_Timeout  0         0         0         0
VPN IKE upd    15       0         0         0

```

```

VPN IPSEC upd  90      0      0      0
VPN CTCP upd   0      0      0      0
VPN SDI upd    0      0      0      0
VPN DHCP upd   0      0      0      0

```

```

Logical Update Queue Information
          Cur      Max      Total
Recv Q:   0      1      1895
Xmit Q:   0      0      1940

```

The following is sample output from the **show failover group** command for Active/Active Failover. The information displayed is similar to that of the **show failover** command, but limited to the specified group. [Table 11-5](#) provides descriptions for the information shown.

```

hostname# show failover group 1

Last Failover at: 04:09:59 UTC Jan 4 2005

This host:      Secondary
                State:          Active
                Active time:    186 (sec)

                admin Interface outside (192.168.5.121): Normal
                admin Interface inside (192.168.0.1): Normal

Other host:     Primary
                State:          Standby
                Active time:    0 (sec)

                admin Interface outside (192.168.5.131): Normal
                admin Interface inside (192.168.0.11): Normal

Stateful Failover Logical Update Statistics
Status: Configured.
RPC services    0      0      0      0
TCP conn       33      0      0      0
UDP conn        0      0      0      0
ARP tbl        12      0      0      0
Xlate_Timeout  0      0      0      0
GTP PDP         0      0      0      0
GTP PDPMCB     0      0      0      0

```

Table 11-5 Show Failover Display Description

Field	Options
Failover	<ul style="list-style-type: none"> • On • Off
Failover Unit	Primary or Secondary.
Failover LAN Interface	Displays the logical and physical name of the failover link.
Unit Poll frequency	Displays the number of seconds between hello messages sent to the peer unit and the number of seconds during which the unit must receive a hello message on the failover link before declaring the peer failed.
Interface Poll frequency	<i>n</i> seconds The number of seconds you set with the failover polltime interface command. The default is 15 seconds.

Table 11-5 Show Failover Display Description (continued)

Field	Options
Interface Policy	Displays the number or percentage of interfaces that must fail before triggering failover.
Monitored Interfaces	Displays the number of interfaces monitored out of the maximum possible.
Group 1 Last Failover at: Group 2 Last Failover at:	The date and time of the last failover for each group in the following form: <i>hh:mm:ss UTC DayName Month Day yyyy</i> UTC (Coordinated Universal Time) is equivalent to GMT (Greenwich Mean Time).
This host: Other host:	For each host, the display shows the following information.
Role	Primary or Secondary
System State	<ul style="list-style-type: none"> • Active or Standby Ready • Active Time in seconds
Group 1 State Group 2 State	<ul style="list-style-type: none"> • Active or Standby Ready • Active Time in seconds
slot <i>x</i>	Information about the module in the slot or empty.
<i>context</i> Interface <i>name</i> (<i>n.n.n.n</i>):	For each interface, the display shows the IP address currently being used on each unit, as well as one of the following conditions: <ul style="list-style-type: none"> • Failed—The interface has failed. • No link—The interface line protocol is down. • Normal—The interface is working correctly. • Link Down—The interface has been administratively shut down. • Unknown—The security appliance cannot determine the status of the interface. • Waiting—Monitoring of the network interface on the other unit has not yet started.
Stateful Failover Logical Update Statistics	The following fields relate to the Stateful Failover feature. If the Link field shows an interface name, the Stateful Failover statistics are shown.
Link	<ul style="list-style-type: none"> • <i>interface_name</i>—The interface used for the Stateful Failover link. • Unconfigured—You are not using Stateful Failover. • up—The interface is up and functioning. • down—The interface is either administratively shutdown or is physically down. • failed—The interface has failed and is not passing stateful data.

Table 11-5 Show Failover Display Description (continued)

Field	Options
Stateful Obj	<p>For each field type, the following statistics are used. They are counters for the number of state information packets sent between the two units; the fields do not necessarily show active connections through the unit.</p> <ul style="list-style-type: none"> xmit—Number of transmitted packets to the other unit xerr—Number of errors that occurred while transmitting packets to the other unit rcv—Number of received packets rerr—Number of errors that occurred while receiving packets from the other unit
General	Sum of all stateful objects.
sys cmd	Logical update system commands; for example, LOGIN and Stay Alive.
up time	Up time, which the active unit passes to the standby unit.
RPC services	Remote Procedure Call connection information.
TCP conn	TCP connection information.
UDP conn	Dynamic UDP connection information.
ARP tbl	Dynamic ARP table information.
L2BRIDGE tbl	Layer 2 bridge table information (transparent firewall mode only).
Xlate_Timeout	Indicates connection translation timeout information.
VPN IKE upd	IKE connection information.
VPN IPSEC upd	IPSec connection information.
VPN CTCP upd	cTCP tunnel connection information.
VPN SDI upd	SDI AAA connection information.
VPN DHCP upd	Tunneled DHCP connection information.
GTP PDP	GTP PDP update information. This information appears only if inspect GTP is enabled.
GTP PDPMCB	GTP PDPMCB update information. This information appears only if inspect GTP is enabled.
Logical Update Queue Information	<p>For each field type, the following statistics are used:</p> <ul style="list-style-type: none"> Cur—Current number of packets Max—Maximum number of packets Total—Total number of packets
Recv Q	The status of the receive queue.
Xmit Q	The status of the transmit queue.

Viewing Monitored Interfaces

To view the status of monitored interfaces, enter the following command. In single context mode, enter this command in global configuration mode. In multiple context mode, enter this command within a context.

```
primary/context(config)# show monitor-interface
```

For example:

```
hostname/context(config)# show monitor-interface
This host: Primary - Active
  Interface outside (192.168.1.2): Normal
  Interface inside (10.1.1.91): Normal
Other host: Secondary - Standby
  Interface outside (192.168.1.3): Normal
  Interface inside (10.1.1.100): Normal
```

Displaying the Failover Commands in the Running Configuration

To view the failover commands in the running configuration, enter the following command:

```
hostname(config)# show running-config failover
```

All of the failover commands are displayed. On units running multiple context mode, enter this command in the system execution space. Entering **show running-config all failover** displays the failover commands in the running configuration and includes commands for which you have not changed the default value.

Testing the Failover Functionality

To test failover functionality, perform the following steps:

-
- Step 1** Test that your active unit or failover group is passing traffic as expected by using FTP (for example) to send a file between hosts on different interfaces.
- Step 2** Force a failover to the standby unit by entering the following command:
- For Active/Standby failover, enter the following command on the active unit:

```
hostname(config)# no failover active
```
 - For Active/Active failover, enter the following command on the unit where failover group containing the interface connecting your hosts is active:

```
hostname(config)# no failover active group group_id
```
- Step 3** Use FTP to send another file between the same two hosts.

- Step 4** If the test was not successful, enter the **show failover** command to check the failover status.
- Step 5** When you are finished, you can restore the unit or failover group to active status by enter the following command:
- For Active/Standby failover, enter the following command on the active unit:

```
hostname(config)# failover active
```
 - For Active/Active failover, enter the following command on the unit where the failover group containing the interface connecting your hosts is active:

```
hostname(config)# failover active group group_id
```
-

Controlling and Monitoring Failover

This sections describes how to control and monitor failover. This section includes the following topics:

- [Forcing Failover, page 11-45](#)
- [Disabling Failover, page 11-46](#)
- [Restoring a Failed Unit or Failover Group, page 11-46](#)
- [Monitoring Failover, page 11-46](#)

Forcing Failover

To force the standby unit or failover group to become active, enter one of the following commands:

- For Active/Standby failover:

Enter the following command on the standby unit:

```
hostname# failover active
```

Or enter the following command on the active unit:

```
hostname# no failover active
```

- For Active/Active failover:

Enter the following command in the system execution space of the unit where failover group is in the standby state:

```
hostname# failover active group group_id
```

Or, enter the following command in the system execution space of the unit where the failover group is in the active state:

```
hostname# no failover active group group_id
```

Entering the following command in the system execution space causes all failover groups to become active:

```
hostname# failover active
```

Disabling Failover

To disable failover, enter the following command:

```
hostname(config)# no failover
```

Disabling failover on an Active/Standby pair causes the active and standby state of each unit to be maintained until you restart. For example, the standby unit remains in standby mode so that both units do not start passing traffic. To make the standby unit active (even with failover disabled), see the [“Forcing Failover” section on page 11-45](#).

Disabling failover on an Active/Active pair causes the failover groups to remain in the active state on whichever unit they are currently active on, no matter which unit they are configured to prefer. The no failover command should be entered in the system execution space.

Restoring a Failed Unit or Failover Group

To restore a failed unit to an unfailed state, enter the following command:

```
hostname(config)# failover reset
```

To restore a failed Active/Active failover group to an unfailed state, enter the following command:

```
hostname(config)# failover reset group group_id
```

Restoring a failed unit or group to an unfailed state does not automatically make it active; restored units or groups remain in the standby state until made active by failover (forced or natural). An exception is a failover group configured with the **preempt** command. If previously active, a failover group will become active if it is configured with the **preempt** command and if the unit on which it failed is its preferred unit.

Monitoring Failover

When a failover occurs, both security appliances send out system messages. This section includes the following topics:

- [Failover System Messages, page 11-46](#)
- [Debug Messages, page 11-47](#)
- [SNMP, page 11-47](#)

Failover System Messages

The security appliance issues a number of system messages related to failover at priority level 2, which indicates a critical condition. To view these messages, see the *Cisco Security Appliance Logging Configuration and System Log Messages* to enable logging and to see descriptions of the system messages.



Note

During switchover, failover will logically shut down and then bring up interfaces, generating syslog 411001 and 411002 messages. This is normal activity.

Debug Messages

To see debug messages, enter the **debug fover** command. See the *Cisco Security Appliance Command Reference* for more information.

**Note**

Because debugging output is assigned high priority in the CPU process, it can drastically affect system performance. For this reason, use the **debug fover** commands only to troubleshoot specific problems or during troubleshooting sessions with Cisco technical support staff.

SNMP

To receive SNMP syslog traps for failover, configure the SNMP agent to send SNMP traps to SNMP management stations, define a syslog host, and compile the Cisco syslog MIB into your SNMP management station. See the **snmp-server** and **logging** commands in the *Cisco Security Appliance Command Reference* for more information.

Failover Configuration Examples

This section includes sample configurations and network diagrams, and includes the following examples:

- [Cable-Based Active/Standby Failover Example, page 11-48](#)
- [LAN-Based Active/Standby Failover Example, page 11-49](#)
- [LAN-Based Active/Active Failover Example, page 11-51](#)

Cable-Based Active/Standby Failover Example

Figure 11-2 shows the network diagram for a failover configuration using a serial Failover cable.

Figure 11-2 Cable-Based Failover Configuration

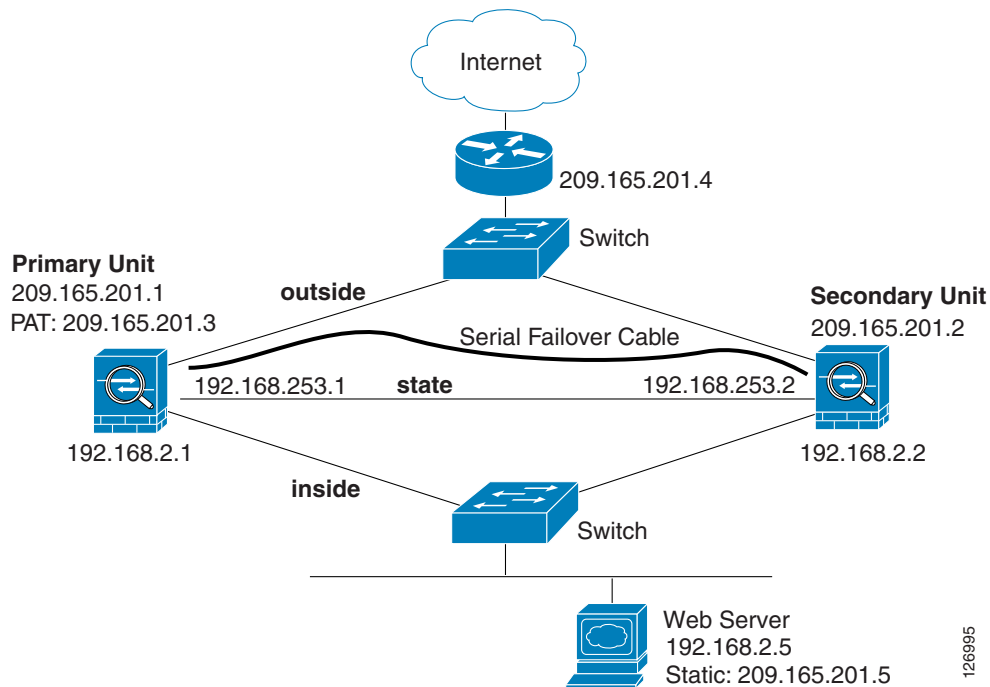

Example 11-4 lists the typical commands in a cable-based failover configuration.

Example 11-4 Cable-Based Failover Configuration

```
interface Ethernet0
  nameif outside
  speed 100full
  ip address 209.165.201.1 255.255.255.224 standby 209.165.201.2
interface Ethernet1
  nameif inside
  speed 100full
  ip address 192.168.2.1 255.255.255.0 standby 192.168.2.2
interface Ethernet2
  nameif interface2
  security-level 4
  no ip address
interface Ethernet3
  description STATE Failover Interface
  enable password BVKtebKhYT.3gsIp encrypted
```

```

passwd iyyMOglaKJgF2fx6 encrypted
telnet 192.168.2.45 255.255.255.255
hostname pixfirewall
access-list acl_out permit tcp any host 209.165.201.5 eq 80
failover
failover link state Ethernet3
failover interface ip state 192.168.253.1 255.255.255.252 standby 192.168.253.2
global (outside) 1 209.165.201.3 netmask 255.255.255.224
nat (inside) 1 0.0.0.0 0.0.0.0
static (inside,outside) 209.165.201.5 192.168.2.5 netmask 255.255.255.255 0 0
access-group acl_out in interface outside
route outside 0.0.0.0 0.0.0.0 209.165.201.4 1

```

LAN-Based Active/Standby Failover Example

Figure 11-3 shows the network diagram for a failover configuration using an Ethernet failover link.

Figure 11-3 LAN-Based Failover Configuration

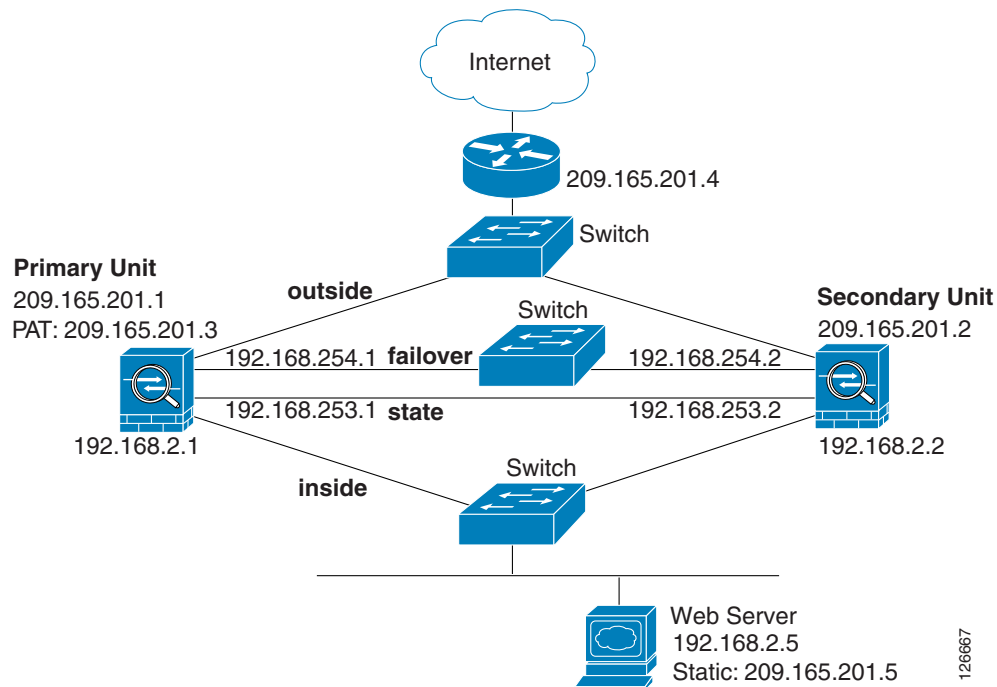

126667

[Example 11-5](#) (primary unit) and [Example 11-6](#) (secondary unit) list the typical commands in a LAN-based failover configuration.

**Note**

The failover lan enable command is required on the PIX security appliance only.

Example 11-5 LAN-Based Failover Configuration: Primary Unit

```
interface Ethernet0
  nameif outside
  ip address 209.165.201.1 255.255.255.224 standby 209.165.201.2
interface Ethernet1
  nameif inside
  ip address 192.168.2.1 255.255.255.0 standby 192.168.2.2
interface Ethernet2
  description LAN Failover Interface
interface ethernet3
  description STATE Failover Interface
enable password BVKtebKhYT.3gsIp encrypted
passwd iyymOglaKJgF2fx6 encrypted
telnet 192.168.2.45 255.255.255.255
hostname pixfirewall
access-list acl_out permit tcp any host 209.165.201.5 eq 80
failover
failover lan unit primary
failover lan interface failover Ethernet2
failover lan enable
failover key *****
failover link state Ethernet3
failover interface ip failover 192.168.254.1 255.255.255.0 standby 192.168.254.2
failover interface ip state 192.168.253.1 255.255.255.0 standby 192.168.253.2
global (outside) 1 209.165.201.3 netmask 255.255.255.224
nat (inside) 1 0.0.0.0 0.0.0.0
static (inside,outside) 209.165.201.5 192.168.2.5 netmask 255.255.255.255 0 0
access-group acl_out in interface outside
route outside 0.0.0.0 0.0.0.0 209.165.201.4 1
```

[Example 11-6](#) shows the configuration for the secondary unit.

Example 11-6 LAN-Based Failover Configuration: Secondary Unit

```
failover
failover lan unit secondary
failover lan interface failover ethernet2
failover lan enable
failover lan key *****
failover interface ip failover 192.168.254.1 255.255.255.0 standby 192.168.254.2
```

LAN-Based Active/Active Failover Example

The following example shows how to configure Active/Active failover. In this example there are 2 user contexts, named admin and ctx1. [Figure 11-4](#) shows the network diagram for the example.

Figure 11-4 Active/Active Failover Configuration

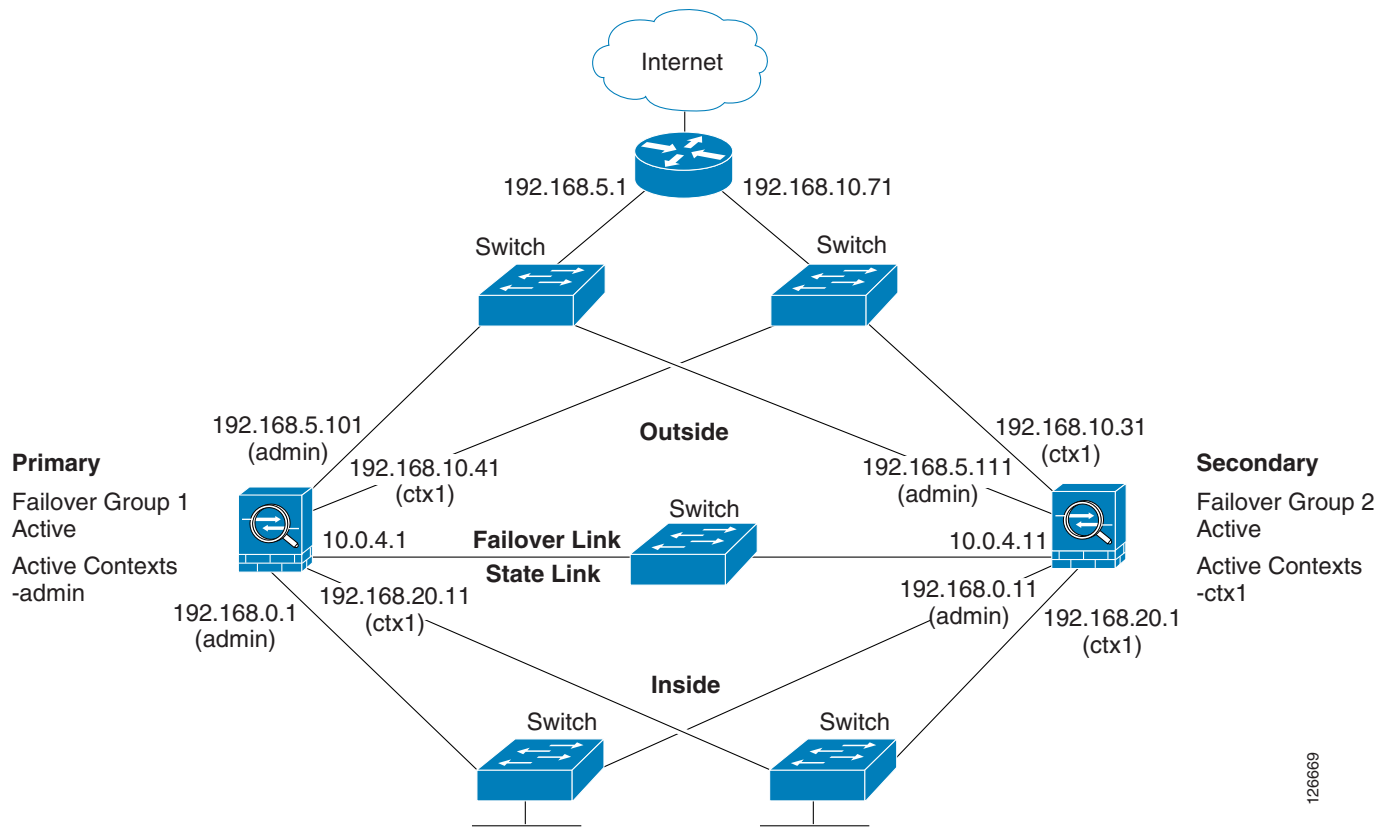

126669

[Example 11-7](#) shows the configuration for the system context. [Example 11-8](#) and [Example 11-9](#) show the configurations for each context.

Example 11-7 System Context Configuration

```
interface Ethernet0
  description LAN/STATE Failover Interface
interface Ethernet1
interface Ethernet2
interface Ethernet3
interface Ethernet4
interface Ethernet5
interface Ethernet6
interface Ethernet7
interface Ethernet8
interface Ethernet9
```

```

enable password 8Ry2YjIyt7RRXU24 encrypted
passwd 2KFQnbNIGI.2KYOU encrypted
hostname ciscopix
boot system flash:/cdisk.bin
ftp mode passive
no pager
failover
failover lan unit primary
failover lan interface folink Ethernet0
failover link folink Ethernet0
failover interface ip folink 10.0.4.1 255.255.255.0 standby 10.0.4.11
failover group 1
    primary
    preempt
failover group 2
    secondary
    preempt
no asdm history enable
arp timeout 14400
timeout xlate 3:00:00
timeout conn 1:00:00 half-closed 0:10:00 udp 0:02:00 icmp 0:00:02 rpc 0:10:00 h323 0:05:00
h225 1:00:00 mgcp 0:05:00 mgcp-pat 0:05:00 sip 0:30:00 sip_media 0:02:00
timeout uauth 0:05:00 absolute
no snmp-server location
no snmp-server contact
snmp-server enable traps snmp
console timeout 0
terminal width 80

admin-context admin
context admin
    description admin
    allocate-interface Ethernet1
    allocate-interface Ethernet2
    config-url flash:admin.cfg
    join-failover-group 1

context ctx1
    description context 1
    allocate-interface Ethernet3
    allocate-interface Ethernet4
    config-url flash:ctx1.cfg
    join-failover-group 2

Cryptochecksum:e46a0587966b4c13bf59d7992f994e1e
: end
ciscopix(config)#

ciscopix(config)# changeto context admin
ciscopix/admin(config)#
ciscopix/admin(config)# show running-config
: Saved
:

```

Example 11-8 The admin Context Configuration

```

interface Ethernet1
    nameif outside
    security-level 0
    ip address 192.168.5.101 255.255.255.0 standby 192.168.5.111

interface Ethernet2
    nameif inside

```

```

security-level 100
ip address 192.168.0.1 255.255.255.0 standby 192.168.0.11

enable password 8Ry2YjIyt7RRXU24 encrypted
passwd 2KFQnbNIdI.2KYOU encrypted
hostname admin
pager lines 24
mtu outside 1500
mtu inside 1500
no vpn-addr-assign aaa
no vpn-addr-assign dhcp
no vpn-addr-assign local
monitor-interface outside
monitor-interface inside
no asdm history enable
arp timeout 14400
route outside 0.0.0.0 0.0.0.0 192.168.5.1 1
timeout xlate 3:00:00
timeout conn 1:00:00 half-closed 0:10:00 udp 0:02:00 icmp 0:00:02 rpc 0:10:00 h323 0:05:00
h225 1:00:00 mgcp 0:05:00 mgcp-pat 0:05:00 sip 0:30:00 sip_media 0:02:00
timeout uauth 0:05:00 absolute
no snmp-server location
no snmp-server contact
snmp-server enable traps snmp
fragment size 200 outside
fragment chain 24 outside
fragment timeout 5 outside
fragment size 200 inside
fragment chain 24 inside
fragment timeout 5 inside
telnet timeout 5
ssh timeout 5
console timeout 0
!
class-map inspection_default
  match default-inspection-traffic
!
!

```

Example 11-9 The ctx1 Context Configuration

```

interface Ethernet3
  nameif inside
  security-level 100
  ip address 192.168.20.1 255.255.255.0 standby 192.168.20.11
!
interface Ethernet4
  nameif outside
  security-level 0
  ip address 192.168.10.31 255.255.255.0 standby 192.168.10.41
  asr-group 1
!
enable password 8Ry2YjIyt7RRXU24 encrypted
passwd 2KFQnbNIdI.2KYOU encrypted
hostname ctx1
access-list 201 extended permit ip any any
pager lines 24
logging console informational
mtu inside 1500
mtu outside 1500
no vpn-addr-assign aaa
no vpn-addr-assign dhcp
no vpn-addr-assign local

```

```
monitor-interface inside
monitor-interface outside
no asdm history enable
arp timeout 14400
access-group 201 in interface outside
route outside 0.0.0.0 0.0.0.0 192.168.10.71 1
timeout xlate 3:00:00
timeout conn 1:00:00 half-closed 0:10:00 udp 0:02:00 icmp 0:00:02 rpc 0:10:00 h323 0:05:00
h225 1:00:00 mgcp 0:05:00 mgcp-pat 0:05:00 sip 0:30:00 sip_media 0:02:00
timeout uauth 0:05:00 absolute
no snmp-server location
no snmp-server contact
snmp-server enable traps snmp
```



PART 2

Configuring the Firewall





Firewall Mode Overview

This chapter describes how the firewall works in each firewall mode.

The security appliance can run in two firewall modes:

- Routed mode
- Transparent mode

In routed mode, the security appliance is considered to be a router hop in the network. It can perform NAT between connected networks, and can use OSPF or passive RIP (in single context mode). Routed mode supports many interfaces. Each interface is on a different subnet. You can share interfaces between contexts.

In transparent mode, the security appliance acts like a “bump in the wire,” or a “stealth firewall,” and is not a router hop. The security appliance connects the same network on its inside and outside interfaces. No dynamic routing protocols or NAT are used. However, like routed mode, transparent mode also requires access lists to allow any traffic through the security appliance, except for ARP packets, which are allowed automatically. Transparent mode can allow certain types of traffic in an access list that are blocked by routed mode, including unsupported routing protocols. Transparent mode can also optionally use EtherType access lists to allow non-IP traffic. Transparent mode only supports two interfaces, an inside interface and an outside interface, in addition to a dedicated management interface, if available for your platform.



Note

The transparent firewall requires a management IP address. The security appliance uses this IP address as the source address for packets originating on the security appliance. The management IP address must be on the same subnet as the connected network.

In multiple context mode, you cannot set the firewall mode separately for each context; you can only set the firewall mode for the entire security appliance.

This chapter includes the following sections:

- [Routed Mode Overview, page 12-1](#)
- [Transparent Mode Overview, page 12-8](#)

Routed Mode Overview

- [IP Routing Support, page 12-2](#)
- [Network Address Translation, page 12-2](#)

- [How Data Moves Through the Security Appliance in Routed Firewall Mode, page 12-3](#)

IP Routing Support

The security appliance acts as a router between connected networks, and each interface requires an IP address on a different subnet. In single context mode, the routed firewall supports OSPF and RIP (in passive mode). Multiple context mode supports static routes only. We recommend using the advanced routing capabilities of the upstream and downstream routers instead of relying on the security appliance for extensive routing needs.

Network Address Translation

NAT substitutes the local address on a packet with a global address that is routable on the destination network. By default, NAT is not required. If you want to enforce a NAT policy that requires hosts on a higher security interface (inside) to use NAT when communicating with a lower security interface (outside), you can enable NAT control (see the **nat-control** command).



Note

NAT control was the default behavior for software versions earlier than Version 7.0. If you upgrade a security appliance from an earlier version, then the **nat-control** command is automatically added to your configuration to maintain the expected behavior.

Some of the benefits of NAT include the following:

- You can use private addresses on your inside networks. Private addresses are not routable on the Internet.
- NAT hides the local addresses from other networks, so attackers cannot learn the real address of a host.
- NAT can resolve IP routing problems by supporting overlapping IP addresses.

[Figure 12-1](#) shows a typical NAT scenario, with a private network on the inside. When the inside user sends a packet to a web server on the Internet, the local source address of the packet is changed to a routable global address. When the web server responds, it sends the response to the global address, and the security appliance receives the packet. The security appliance then translates the global address to the local address before sending it on to the user.

Figure 12-1 NAT Example

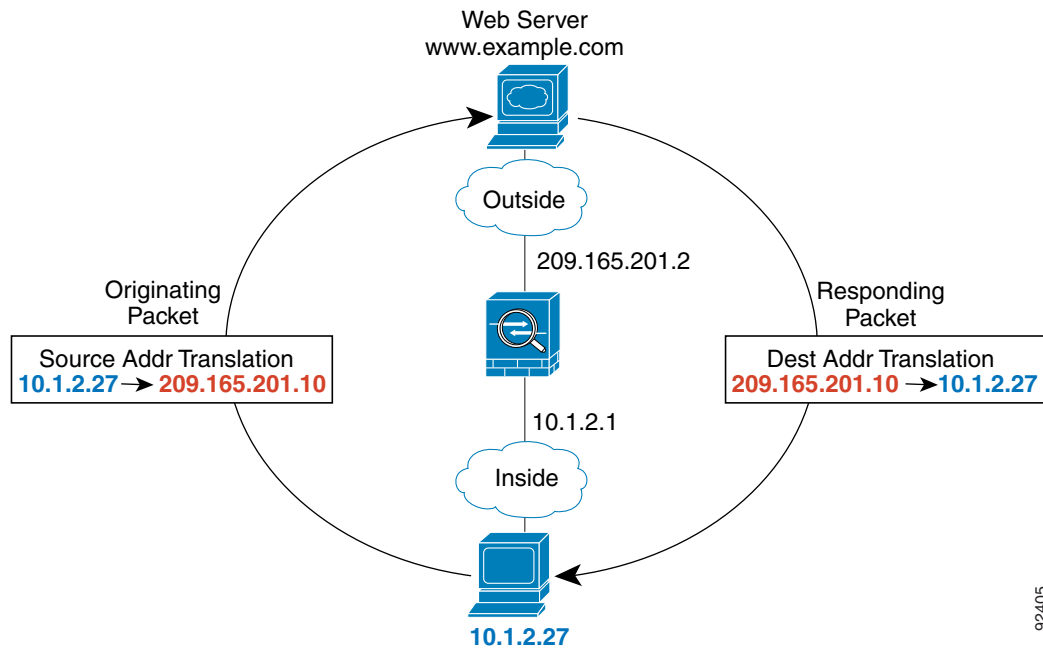

92405

How Data Moves Through the Security Appliance in Routed Firewall Mode

This section describes how data moves through the security appliance in routed firewall mode, and includes the following topics:

- [An Inside User Visits a Web Server, page 12-4](#)
- [An Outside User Visits a Web Server on the DMZ, page 12-5](#)
- [An Inside User Visits a Web Server on the DMZ, page 12-6](#)
- [An Outside User Attempts to Access an Inside Host, page 12-7](#)
- [A DMZ User Attempts to Access an Inside Host, page 12-8](#)

An Inside User Visits a Web Server

Figure 12-2 shows an inside user accessing an outside web server.

Figure 12-2 Inside to Outside

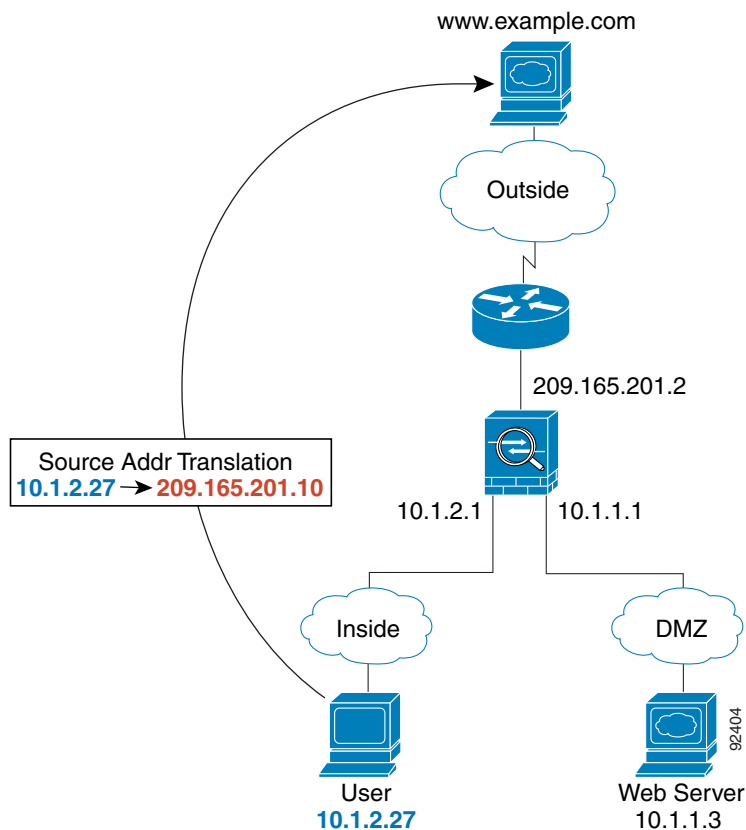

The following steps describe how data moves through the security appliance (see Figure 12-2):

1. The user on the inside network requests a web page from www.example.com.
2. The security appliance receives the packet and because it is a new session, the security appliance verifies that the packet is allowed according to the terms of the security policy (access lists, filters, AAA).

For multiple context mode, the security appliance first classifies the packet according to either a unique interface or a unique destination address associated with a context; the destination address is associated by matching an address translation in a context. In this case, the interface would be unique; the www.example.com IP address does not have a current address translation in a context.

3. The security appliance translates the local source address (10.1.2.27) to the global address 209.165.201.10, which is on the outside interface subnet.

The global address could be on any subnet, but routing is simplified when it is on the outside interface subnet.

4. The security appliance then records that a session is established and forwards the packet from the outside interface.

5. When `www.example.com` responds to the request, the packet goes through the security appliance, and because the session is already established, the packet bypasses the many lookups associated with a new connection. The security appliance performs NAT by translating the global destination address to the local user address, `10.1.2.27`.
6. The security appliance forwards the packet to the inside user.

An Outside User Visits a Web Server on the DMZ

Figure 12-3 shows an outside user accessing the DMZ web server.

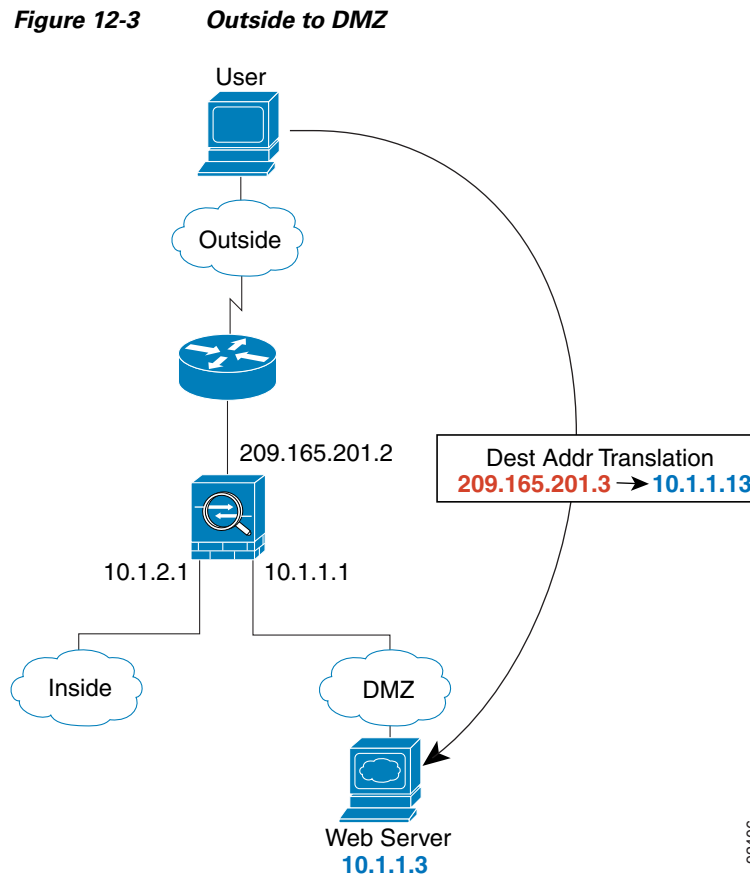

The following steps describe how data moves through the security appliance (see Figure 12-3):

1. A user on the outside network requests a web page from the DMZ web server using the global destination address of `209.165.201.3`, which is on the outside interface subnet.
2. The security appliance receives the packet and because it is a new session, the security appliance verifies that the packet is allowed according to the terms of the security policy (access lists, filters, AAA).

For multiple context mode, the security appliance first classifies the packet according to either a unique interface or a unique destination address associated with a context; the destination address is associated by matching an address translation in a context. In this case, the classifier “knows” that the DMZ web server address belongs to a certain context because of the server address translation.

3. The security appliance translates the destination address to the local address `10.1.1.3`.

4. The security appliance then adds a session entry to the fast path and forwards the packet from the DMZ interface.
5. When the DMZ web server responds to the request, the packet goes through the security appliance and because the session is already established, the packet bypasses the many lookups associated with a new connection. The security appliance performs NAT by translating the local source address to 209.165.201.3.
6. The security appliance forwards the packet to the outside user.

An Inside User Visits a Web Server on the DMZ

Figure 12-4 shows an inside user accessing the DMZ web server.

Figure 12-4 Inside to DMZ

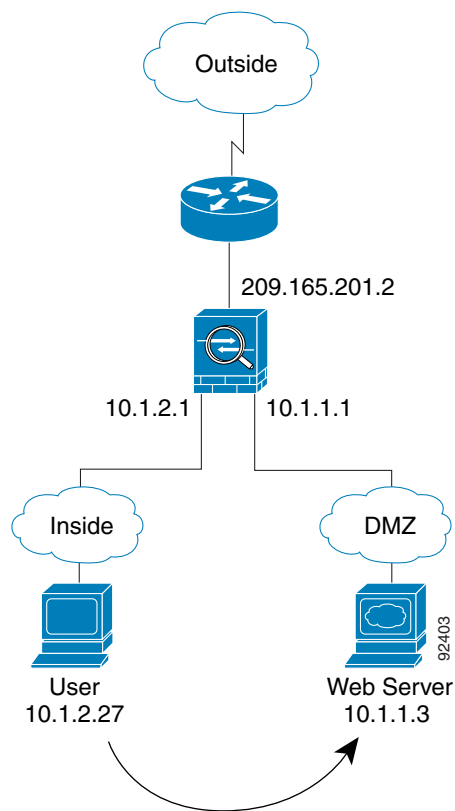

The following steps describe how data moves through the security appliance (see Figure 12-4):

1. A user on the inside network requests a web page from the DMZ web server using the destination address of 10.1.1.3.
2. The security appliance receives the packet and because it is a new session, the security appliance verifies that the packet is allowed according to the terms of the security policy (access lists, filters, AAA).

For multiple context mode, the security appliance first classifies the packet according to either a unique interface or a unique destination address associated with a context; the destination address is associated by matching an address translation in a context. In this case, the interface is unique; the web server IP address does not have a current address translation.

3. The security appliance then records that a session is established and forwards the packet out of the DMZ interface.
4. When the DMZ web server responds to the request, the packet goes through the fast path, which lets the packet bypass the many lookups associated with a new connection.
5. The security appliance forwards the packet to the inside user.

An Outside User Attempts to Access an Inside Host

Figure 12-5 shows an outside user attempting to access the inside network.

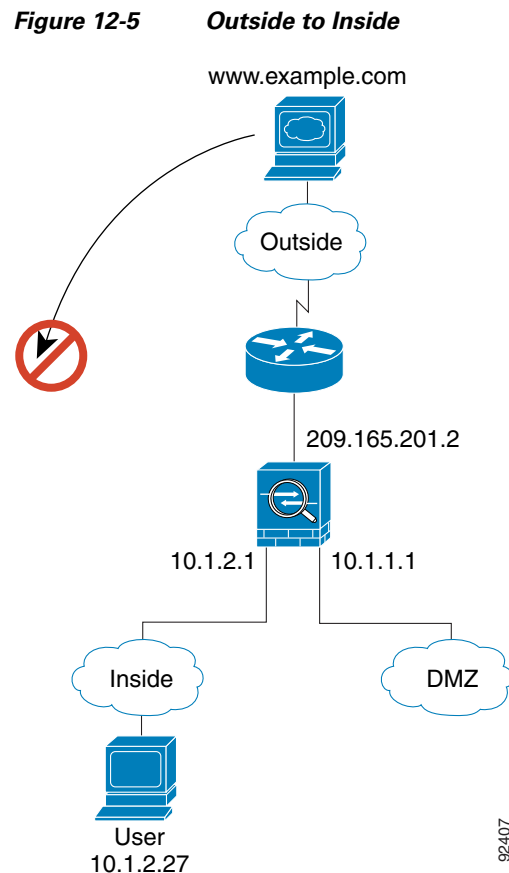

The following steps describe how data moves through the security appliance (see Figure 12-5):

1. A user on the outside network attempts to reach an inside host (assuming the host has a routable IP address).
If the inside network uses private addresses, no outside user can reach the inside network without NAT. The outside user might attempt to reach an inside user by using an existing NAT session.
2. The security appliance receives the packet and because it is a new session, the security appliance verifies if the packet is allowed according to the security policy (access lists, filters, AAA).
3. The packet is denied, and the security appliance drops the packet and logs the connection attempt.
If the outside user is attempting to attack the inside network, the security appliance employs many technologies to determine if a packet is valid for an already established session.

A DMZ User Attempts to Access an Inside Host

Figure 12-6 shows a user in the DMZ attempting to access the inside network.

Figure 12-6 DMZ to Inside

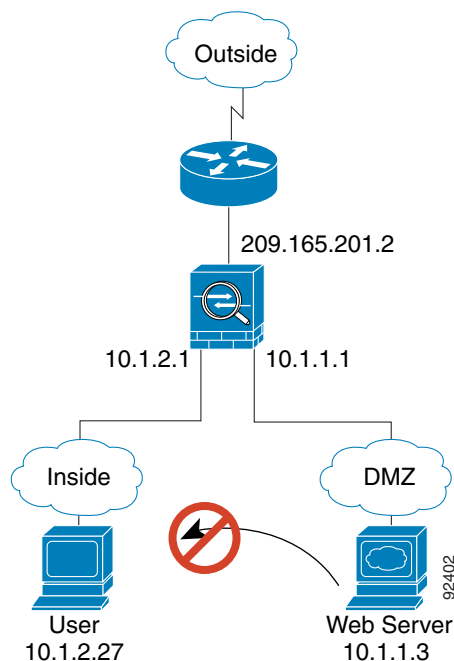

The following steps describe how data moves through the security appliance (see Figure 12-6):

1. A user on the DMZ network attempts to reach an inside host. Because the DMZ does not have to route the traffic on the internet, the private addressing scheme does not prevent routing.
2. The security appliance receives the packet and because it is a new session, the security appliance verifies if the packet is allowed according to the security policy (access lists, filters, AAA).
3. The packet is denied, and the security appliance drops the packet and logs the connection attempt.

Transparent Mode Overview

This section describes transparent firewall mode, and includes the following topics:

- [Transparent Firewall Features, page 12-9](#)
- [Using the Transparent Firewall in Your Network, page 12-10](#)
- [Transparent Firewall Guidelines, page 12-10](#)
- [Unsupported Features in Transparent Mode, page 12-11](#)
- [How Data Moves Through the Transparent Firewall, page 12-12](#)

Transparent Firewall Features

Traditionally, a firewall is a routed hop and acts as a default gateway for hosts that connect to one of its screened subnets. A transparent firewall, on the other hand, is a Layer 2 firewall that acts like a “bump in the wire,” or a “stealth firewall,” and is not seen as a router hop to connected devices. The security appliance connects the same network on its inside and outside ports. Because the firewall is not a routed hop, you can easily introduce a transparent firewall into an existing network; IP readdressing is unnecessary.

Maintenance is facilitated because there are no complicated routing patterns to troubleshoot and no NAT configuration.

Even though transparent mode acts as a bridge, Layer 3 traffic, such as IP traffic, cannot pass through the security appliance unless you explicitly permit it with an extended access list. The only traffic allowed through the transparent firewall without an access list is ARP traffic. ARP traffic can be controlled by ARP inspection.

In routed mode, some types of traffic cannot pass through the security appliance even if you allow it in an access list. The transparent firewall, however, can allow any traffic through using either an extended access list (for IP traffic) or an EtherType access list (for non-IP traffic).

**Note**

The transparent mode security appliance does not pass CDP packets.

For example, you can establish routing protocol adjacencies through a transparent firewall; you can allow OSPF, RIP, EIGRP, or BGP traffic through based on an extended access list. Likewise, protocols like HSRP or VRRP can pass through the security appliance.

Non-IP traffic (for example AppleTalk, IPX, BPDUs, and MPLS) can be configured to go through using an EtherType access list.

For features that are not directly supported on the transparent firewall, you can allow traffic to pass through so that upstream and downstream routers can support the functionality. For example, by using an extended access list, you can allow DHCP traffic (instead of the unsupported DHCP relay feature) or multicast traffic such as that created by IP/TV.

When the security appliance runs in transparent mode, the outgoing interface of a packet is determined by performing a MAC address lookup instead of a route lookup. Route statements can still be configured, but they only apply to security appliance-originated traffic. For example, if your syslog server is located on a remote network, you must use a static route so the security appliance can reach that subnet.

Using the Transparent Firewall in Your Network

Figure 12-7 shows a typical transparent firewall network where the outside devices are on the same subnet as the inside devices. The inside router and hosts appear to be directly connected to the outside router.

Figure 12-7 Transparent Firewall Network

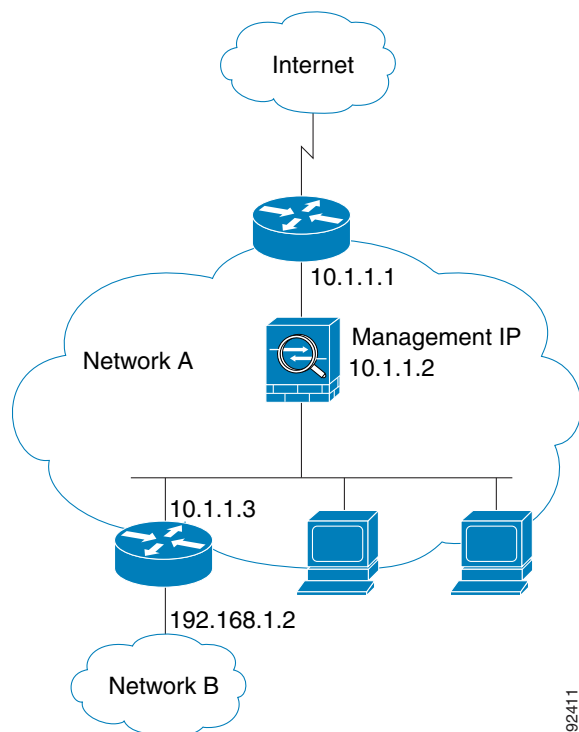

92411

Transparent Firewall Guidelines

Follow these guidelines when planning your transparent firewall network:

- A management IP address is required; for multiple context mode, an IP address is required for each context.

Unlike routed mode, which requires an IP address for each interface, a transparent firewall has an IP address assigned to the entire device. The security appliance uses this IP address as the source address for packets originating on the security appliance, such as system messages or AAA communications.

The management IP address must be on the same subnet as the connected network. You cannot set the subnet to a host subnet (255.255.255.255).



Note If the management IP address is not configured, transient traffic does not pass through the transparent firewall. For multiple context mode, transient traffic does not pass through virtual contexts.

- The transparent security appliance uses an inside interface and an outside interface only. If your platform includes a dedicated management interface, you can also configure the management interface or subinterface for management traffic only.
In single mode, you can only use two data interfaces (and the dedicated management interface, if available) even if your security appliance includes more than two interfaces.
- Each directly connected network must be on the same subnet.
- Do not specify the security appliance management IP address as the default gateway for connected devices; devices need to specify the router on the other side of the security appliance as the default gateway.
- For multiple context mode, each context must use different interfaces; you cannot share an interface across contexts.
- For multiple context mode, each context typically uses a different subnet. You can use overlapping subnets, but your network topology requires router and NAT configuration to make it possible from a routing standpoint.
- You must use an extended access list to allow Layer 3 traffic, such as IP traffic, through the security appliance.

You can also optionally use an EtherType access list to allow non-IP traffic through.

Unsupported Features in Transparent Mode

The following features are not supported in transparent mode:

- NAT
NAT is performed on the upstream router.
- Dynamic routing protocols
You can, however, add static routes for traffic originating on the security appliance. You can also allow dynamic routing protocols through the security appliance using an extended access list.
- IPv6
- DHCP relay
The transparent firewall can act as a DHCP server, but it does not support the DHCP relay commands. DHCP relay is not required because you can allow DHCP traffic to pass through using an extended access list.
- Quality of Service
- Multicast
You can, however, allow multicast traffic through the security appliance by allowing it in an extended access list.
- VPN termination for through traffic
The transparent firewall supports site-to-site VPN tunnels for management connections only. It does not terminate VPN connections for traffic through the security appliance. You can pass VPN traffic through the security appliance using an extended access list, but it does not terminate non-management connections.

How Data Moves Through the Transparent Firewall

Figure 12-8 shows a typical transparent firewall implementation with an inside network that contains a public web server. The security appliance has an access list so that the inside users can access Internet resources. Another access list lets the outside users access only the web server on the inside network.

Figure 12-8 Typical Transparent Firewall Data Path

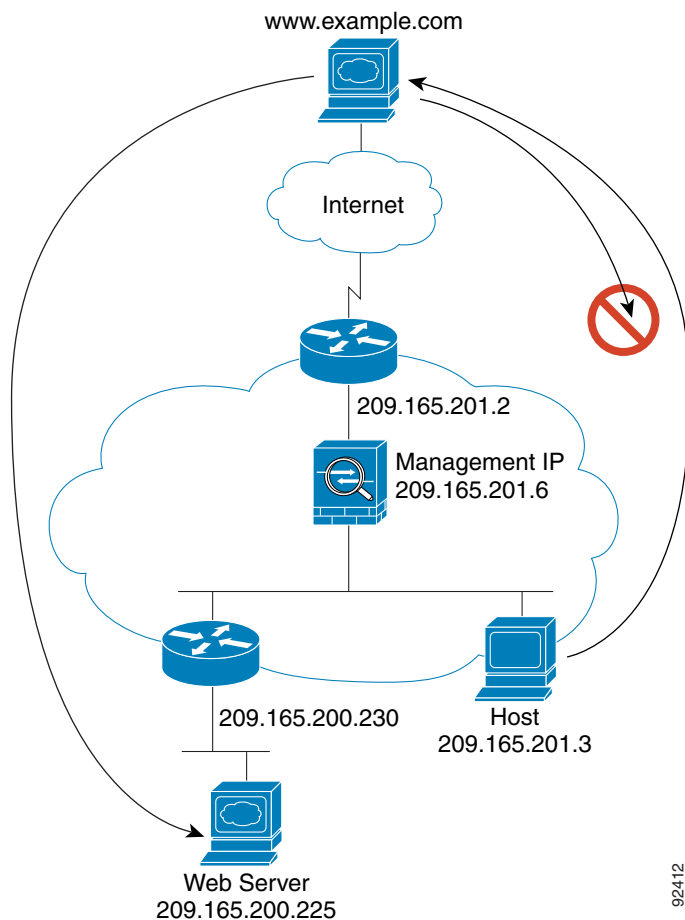

This section describes how data moves through the security appliance, and includes the following topics:

- [An Inside User Visits a Web Server, page 12-13](#)
- [An Outside User Visits a Web Server on the Inside Network, page 12-14](#)
- [An Outside User Attempts to Access an Inside Host, page 12-15](#)

92412

An Inside User Visits a Web Server

Figure 12-9 shows an inside user accessing an outside web server.

Figure 12-9 Inside to Outside

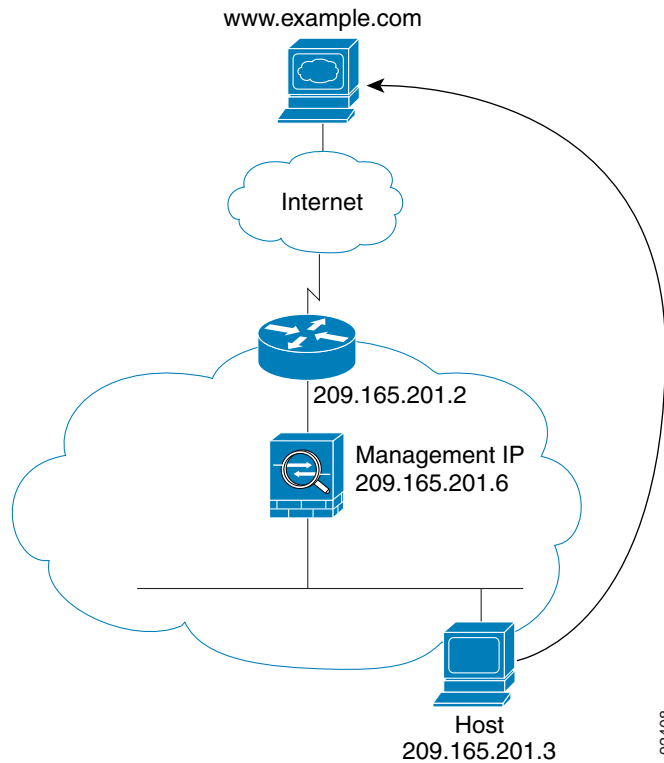

The following steps describe how data moves through the security appliance (see Figure 12-9):

1. The user on the inside network requests a web page from www.example.com.
2. The security appliance receives the packet and adds the source MAC address to the MAC address table, if required. Because it is a new session, it verifies that the packet is allowed according to the terms of the security policy (access lists, filters, AAA).
For multiple context mode, the security appliance first classifies the packet according to a unique interface.
3. The security appliance records that a session is established.
4. If the destination MAC address is in its table, the security appliance forwards the packet out of the outside interface. The destination MAC address is that of the upstream router, 209.186.201.2.
If the destination MAC address is not in the security appliance table, the security appliance attempts to discover the MAC address by sending an ARP request and a ping. The first packet is dropped.
5. When the web server responds to the request, the security appliance adds the web server MAC address to the MAC address table, if required, and because the session is already established, the packet bypasses the many lookups associated with a new connection.
6. The security appliance forwards the packet to the inside user.

An Outside User Visits a Web Server on the Inside Network

Figure 12-10 shows an outside user accessing the inside web server.

Figure 12-10 Outside to Inside

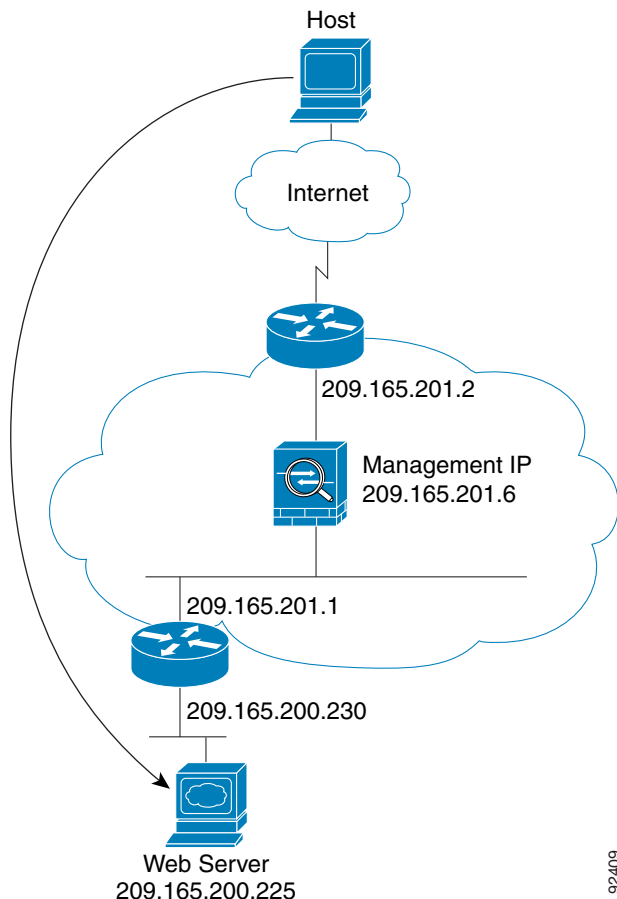

The following steps describe how data moves through the security appliance (see Figure 12-10):

1. A user on the outside network requests a web page from the inside web server.
2. The security appliance receives the packet and adds the source MAC address to the MAC address table, if required. Because it is a new session, it verifies that the packet is allowed according to the terms of the security policy (access lists, filters, AAA).
For multiple context mode, the security appliance first classifies the packet according to a unique interface.
3. The security appliance records that a session is established.
4. If the destination MAC address is in its table, the security appliance forwards the packet out of the inside interface. The destination MAC address is that of the downstream router, 209.186.201.1.
If the destination MAC address is not in the security appliance table, the security appliance attempts to discover the MAC address by sending an ARP request and a ping. The first packet is dropped.
5. When the web server responds to the request, the security appliance adds the web server MAC address to the MAC address table, if required, and because the session is already established, the packet bypasses the many lookups associated with a new connection.
6. The security appliance forwards the packet to the outside user.

An Outside User Attempts to Access an Inside Host

Figure 12-11 shows an outside user attempting to access a host on the inside network.

Figure 12-11 Outside to Inside

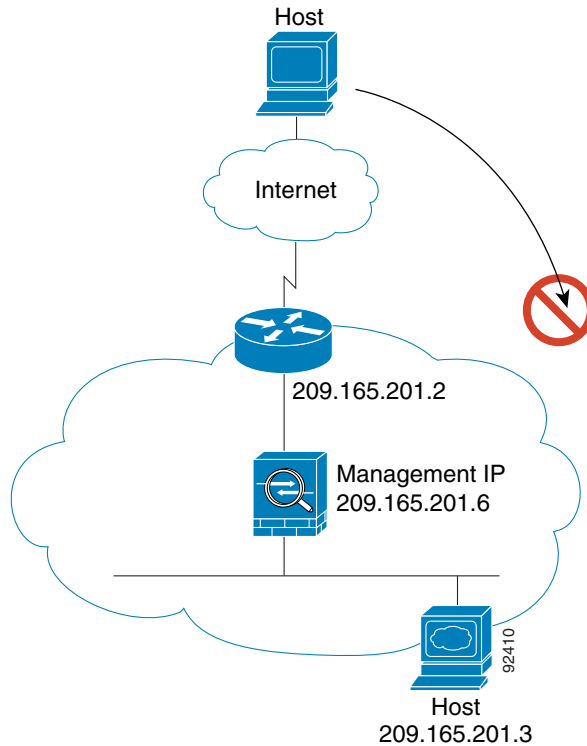

The following steps describe how data moves through the security appliance (see Figure 12-11):

1. A user on the outside network attempts to reach an inside host.
2. The security appliance receives the packet and adds the source MAC address to the MAC address table, if required. Because it is a new session, it verifies if the packet is allowed according to the terms of the security policy (access lists, filters, AAA).
For multiple context mode, the security appliance first classifies the packet according to a unique interface.
3. The packet is denied, and the security appliance drops the packet.
4. If the outside user is attempting to attack the inside network, the security appliance employs many technologies to determine if a packet is valid for an already established session.



Identifying Traffic with Access Lists

This chapter describes how to identify traffic with access lists.

This chapter includes the following topics:

- [Access List Overview, page 13-1](#)
- [Adding an Extended Access List, page 13-5](#)
- [Adding an EtherType Access List, page 13-7](#)
- [Adding a Standard Access List, page 13-9](#)
- [Adding a Webtype Access List, page 13-10](#)
- [Simplifying Access Lists with Object Grouping, page 13-10](#)
- [Adding Remarks to Access Lists, page 13-16](#)
- [Time Range Options, page 13-17](#)
- [Logging Access List Activity, page 13-17](#)

For information about IPv6 access lists, see the [“Configuring IPv6 Access Lists”](#) section on page 9-4.

Access List Overview

Access lists are made up of one or more Access Control Entries. An ACE is a single entry in an access list that specifies a permit or deny rule, and is applied to a protocol, a source and destination IP address or network, and optionally the source and destination ports.

Access lists are used in a variety of features. If your feature uses Modular Policy Framework, you can use an access list to identify traffic within a traffic class map. For more information on Modular Policy Framework, see [Chapter 18, “Using Modular Policy Framework.”](#)

This section includes the following topics:

- [Access List Types, page 13-2](#)
- [Access Control Entry Order, page 13-2](#)
- [Access Control Implicit Deny, page 13-3](#)
- [IP Addresses Used for Access Lists When You Use NAT, page 13-3](#)

Access List Types

Table 13-1 lists the types of access lists and some common uses for them.

Table 13-1 Access List Types and Common Uses

Access List Use	Access List Type	Description
Control network access for IP traffic (routed and transparent mode)	Extended	The security appliance does not allow any traffic unless it is explicitly permitted by an extended access list.
Identify traffic for AAA rules	Extended	AAA rules use access lists to identify traffic.
Control network access for IP traffic for a given user	Extended, downloaded from a AAA server per user	You can configure the RADIUS server to download a dynamic access list to be applied to the user, or the server can send the name of an access list that you already configured on the security appliance.
Identify addresses for NAT (policy NAT and NAT exemption)	Extended	Policy NAT lets you identify local traffic for address translation by specifying the source and destination addresses in an extended access list.
Establish VPN access	Extended	You can use an extended access list in VPN commands.
Identify traffic in a traffic class map for Modular Policy	Extended EtherType	Access lists can be used to identify traffic in a class map, which is used for features that support Modular Policy Framework. Features that support Modular Policy Framework include TCP and general connection settings, and inspection.
For transparent firewall mode, control network access for non-IP traffic	EtherType	You can configure an access list that controls traffic based on its EtherType.
Identify OSPF route redistribution	Standard	Standard access lists include only the destination address. You can use a standard access list to control the redistribution of OSPF routes.
Filtering for WebVPN	Webtype	You can configure a Webtype access list to filter URLs.

Access Control Entry Order

An access list is made up of one or more Access Control Entries. Depending on the access list type, you can specify the source and destination addresses, the protocol, the ports (for TCP or UDP), the ICMP type (for ICMP), or the EtherType.

Each ACE that you enter for a given access list name is appended to the end of the access list.

The order of ACEs is important. When the security appliance decides whether to forward or drop a packet, the security appliance tests the packet against each ACE in the order in which the entries are listed. After a match is found, no more ACEs are checked. For example, if you create an ACE at the beginning of an access list that explicitly permits all traffic, no further statements are ever checked.

You can disable an ACE by specifying the keyword **inactive** in the **access-list** command.

Access Control Implicit Deny

Access lists have an implicit deny at the end of the list, so unless you explicitly permit it, traffic cannot pass. For example, if you want to allow all users to access a network through the security appliance except for particular addresses, then you need to deny the particular addresses and then permit all others.

IP Addresses Used for Access Lists When You Use NAT

When you use NAT, the IP addresses you specify for an access list depend on the interface to which the access list is attached; you need to use addresses that are valid on the network connected to the interface. This guideline applies for both inbound and outbound access lists: the direction does not determine the address used, only the interface does.

For example, you want to apply an access list to the inbound direction of the inside interface. You configure the security appliance to perform NAT on the inside source addresses when they access outside addresses. Because the access list is applied to the inside interface, the source addresses are the original untranslated addresses. Because the outside addresses are not translated, the destination address used in the access list is the real address (see [Figure 13-1](#)).

Figure 13-1 IP Addresses in Access Lists: NAT Used for Source Addresses

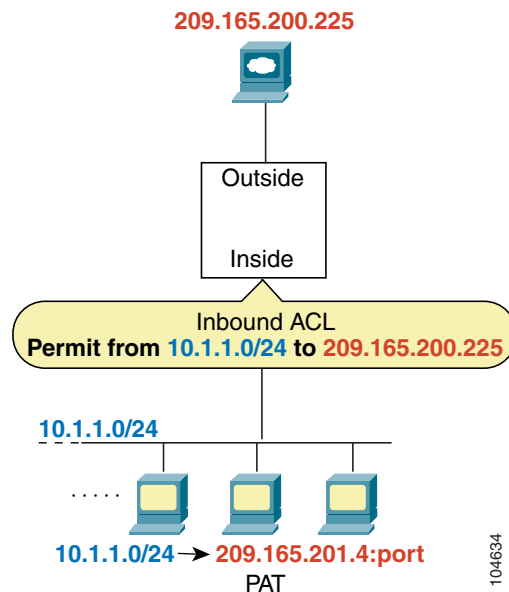

See the following commands for this example:

```
hostname(config)# access-list INSIDE extended permit ip 10.1.1.0 255.255.255.0 host
209.165.200.225
hostname(config)# access-group INSIDE in interface inside
```

If you want to allow an outside host to access an inside host, you can apply an inbound access list on the outside interface. You need to specify the translated address of the inside host in the access list because that address is the address that can be used on the outside network (see [Figure 13-2](#)).

Figure 13-2 IP Addresses in Access Lists: NAT used for Destination Addresses

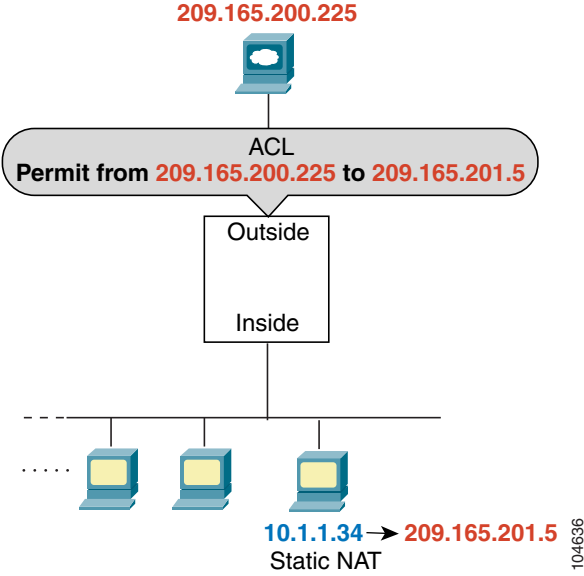

See the following commands for this example:

```
hostname(config)# access-list OUTSIDE extended permit ip host 209.165.200.225 host 209.165.201.5
hostname(config)# access-group OUTSIDE in interface outside
```

If you perform NAT on both interfaces, keep in mind the addresses that are visible to a given interface. In Figure 13-3, an outside server uses static NAT so that a translated address appears on the inside network.

Figure 13-3 IP Addresses in Access Lists: NAT used for Source and Destination Addresses

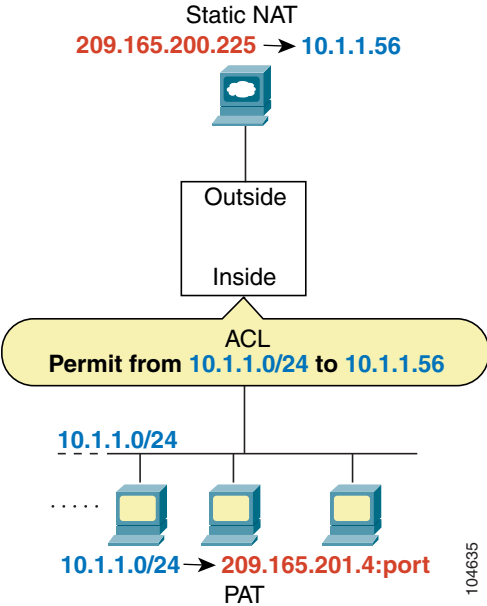

See the following commands for this example:

```
hostname(config)# access-list INSIDE extended permit ip 10.1.1.0 255.255.255.0 host
10.1.1.56
hostname(config)# access-group INSIDE in interface inside
```

Adding an Extended Access List

This section describes how to add an extended access list, and includes the following sections:

- [Extended Access List Overview, page 13-5](#)
- [Adding an Extended ACE, page 13-6](#)

Extended Access List Overview

An extended access list is made up of one or more ACEs, in which you can specify the line number to insert the ACE, source and destination addresses, and, depending on the ACE type, the protocol, the ports (for TCP or UDP), or the ICMP type (for ICMP). You can identify all of these parameters within the **access-list** command, or you can use object groups for each parameter. This section describes how to identify the parameters within the command. To use object groups, see the [“Simplifying Access Lists with Object Grouping”](#) section on page 13-10.

For information about logging options that you can add to the end of the ACE, see the [“Logging Access List Activity”](#) section on page 13-17. For information about time range options, see [“Time Range Options”](#) section on page 13-17.

For TCP and UDP connections, you do not need an access list to allow returning traffic, because the FWSM allows all returning traffic for established, bidirectional connections. For connectionless protocols such as ICMP, however, the security appliance establishes unidirectional sessions, so you either need access lists to allow ICMP in both directions (by applying access lists to the source and destination interfaces), or you need to enable the ICMP inspection engine. The ICMP inspection engine treats ICMP sessions as bidirectional connections.

You can apply only one access list of each type (extended and EtherType) to each direction of an interface. You can apply the same access lists on multiple interfaces. See [Chapter 15, “Permitting or Denying Network Access,”](#) for more information about applying an access list to an interface.



Note

If you change the access list configuration, and you do not want to wait for existing connections to time out before the new access list information is used, you can clear the connections using the **clear local-host** command.

Allowing Special IP Traffic through the Transparent Firewall

In routed firewall mode, some types of IP traffic are blocked even if you allow them in an access list, including unsupported dynamic routing protocols and DHCP (unless you configure DHCP relay). Transparent firewall mode can allow any IP traffic through. Because these special types of traffic are connectionless, you need to apply an extended access list to both interfaces, so returning traffic is allowed through.

Table 13-2 lists common traffic types that you can allow through the transparent firewall.

Table 13-2 Transparent Firewall Special Traffic

Traffic Type	Protocol or Port	Notes
BGP	TCP port 179	—
DHCP	UDP ports 67 and 68	If you enable the DHCP server, then the security appliance does not pass DHCP packets.
EIGRP	Protocol 88	—
OSPF	Protocol 89	—
Multicast streams	The UDP ports vary depending on the application.	Multicast streams are always destined to a Class D address (224.0.0.0 to 239.x.x.x).
RIP (v1 or v2)	UDP port 520	—

Adding an Extended ACE

When you enter the **access-list** command for a given access list name, the ACE is added to the end of the access list unless you specify the **line** number.

To add an ACE, enter the following command:

```
hostname(config)# access-list access_list_name [line line_number] [extended]
{deny | permit} protocol source_address mask [operator port] dest_address mask
[operator port | icmp_type] [inactive]
```

If the entry that you are removing is the only entry in the access list, the entire access list is removed.



Tip

Enter the access list name in upper case letters so the name is easy to see in the configuration. You might want to name the access list for the interface (for example, INSIDE), or for the purpose for which it is created (for example, NO_NAT or VPN).

Typically, you identify the **ip** keyword for the protocol, but other protocols are accepted. For a list of protocol names, see the “[Protocols and Applications](#)” section on page D-11.

Enter the **host** keyword before the IP address to specify a single address. In this case, do not enter a mask. Enter the **any** keyword instead of the address and mask to specify any address.

You can specify the source and destination ports only for the **tcp** or **udp** protocols. For a list of permitted keywords and well-known port assignments, see the “[TCP and UDP Ports](#)” section on page D-12. DNS, Discard, Echo, Ident, NTP, RPC, SUNRPC, and Talk each require one definition for TCP and one for UDP. TACACS+ requires one definition for port 49 on TCP.

Use an *operator* to match port numbers used by the source or destination. The permitted operators are as follows:

- **lt**—less than
- **gt**—greater than
- **eq**—equal to
- **neq**—not equal to
- **range**—an inclusive range of values. When you use this operator, specify two port numbers, for example:

```
range 100 200
```

You can specify the ICMP type only for the **icmp** protocol. Because ICMP is a connectionless protocol, you either need access lists to allow ICMP in both directions (by applying access lists to the source and destination interfaces), or you need to enable the ICMP inspection engine (see the “[Adding an ICMP Type Object Group](#)” section on page 13-13). The ICMP inspection engine treats ICMP sessions as stateful connections. To control ping, specify **echo-reply (0)** (security appliance to host) or **echo (8)** (host to security appliance). See the “[Adding an ICMP Type Object Group](#)” section on page 13-13 for a list of ICMP types.

When you specify a network mask, the method is different from the Cisco IOS software **access-list** command. The security appliance uses a network mask (for example, 255.255.255.0 for a Class C mask). The Cisco IOS mask uses wildcard bits (for example, 0.0.0.255).

To make an ACE inactive, use the **inactive** keyword. To reenable it, enter the entire ACE without the **inactive** keyword. This feature lets you keep a record of an inactive ACE in your configuration to make reenabling easier.

To remove an ACE, enter the **no access-list** command with the entire command syntax string as it appears in the configuration:

```
hostname(config)# no access-list access_list_name [line line_number] [extended]
{deny | permit} protocol source_address mask [operator port] dest_address mask
[operator port | icmp_type] [inactive]
```

See the following examples:

The following access list allows all hosts (on the interface to which you apply the access list) to go through the security appliance:

```
hostname(config)# access-list ACL_IN extended permit ip any any
```

The following sample access list prevents hosts on 192.168.1.0/24 from accessing the 209.165.201.0/27 network. All other addresses are permitted.

```
hostname(config)# access-list ACL_IN extended deny tcp 192.168.1.0 255.255.255.0
209.165.201.0 255.255.255.224
hostname(config)# access-list ACL_IN extended permit ip any any
```

If you want to restrict access to only some hosts, then enter a limited permit ACE. By default, all other traffic is denied unless explicitly permitted.

```
hostname(config)# access-list ACL_IN extended permit ip 192.168.1.0 255.255.255.0
209.165.201.0 255.255.255.224
```

The following access list restricts all hosts (on the interface to which you apply the access list) from accessing a website at address 209.165.201.29. All other traffic is allowed.

```
hostname(config)# access-list ACL_IN extended deny tcp any host 209.165.201.29 eq www
hostname(config)# access-list ACL_IN extended permit ip any any
```

Adding an EtherType Access List

Transparent firewall mode only

An EtherType ACE controls any EtherType identified by a 16-bit hexadecimal number. You can identify some types by a keyword for convenience. If you add an ACE to an EtherType access list that specifically denies all traffic, then that ACE also denies IP and ARP traffic, even if you have an extended access list that allows IP traffic. The implicit deny at the end of all access lists allows IP and ARP through.

EtherType ACEs do not allow IPv6 traffic, even if you specify the IPv6 EtherType.

Because EtherTypes are connectionless, you need to apply the access list to both interfaces if you want traffic to pass in both directions. For example, you can permit or deny bridge protocol data units. By default, all BPDUs are denied. The security appliance receives trunk port (Cisco proprietary) BPDUs because security appliance ports are trunk ports. Trunk BPDUs have VLAN information inside the payload, so the security appliance modifies the payload with the outgoing VLAN if you allow BPDUs. If you use failover, you must allow BPDUs on both interfaces with an EtherType access list to avoid bridging loops.

If you allow MPLS, ensure that Label Distribution Protocol and Tag Distribution Protocol TCP connections are established through the security appliance by configuring both MPLS routers connected to the security appliance to use the IP address on the security appliance interface as the router-id for LDP or TDP sessions. (LDP and TDP allow MPLS routers to negotiate the labels (addresses) used to forward packets.)

On Cisco IOS routers, enter the appropriate command for your protocol, LDP or TDP. The *interface* is the interface connected to the security appliance.

```
hostname(config)# mpls ldp router-id interface force
```

Or

```
hostname(config)# tag-switching tdp router-id interface force
```

You can apply only one access list of each type (extended and EtherType) to each direction of an interface. You can also apply the same access lists on multiple interfaces.

To add an EtherType ACE, enter the following command:

```
hostname(config)# access-list access_list_name ethertype {permit | deny} {ipx | bpdu |
mpls-unicast | mpls-multicast | any | hex_number}
```

The *hex_number* is any EtherType that can be identified by a 16-bit hexadecimal number greater than or equal to 0x600. See RFC 1700, “Assigned Numbers,” at <http://www.ietf.org/rfc/rfc1700.txt> for a list of EtherTypes.

To remove an EtherType ACE, enter the **no access-list** command with the entire command syntax string as it appears in the configuration:

```
hostname(config)# no access-list access_list_name ethertype {permit | deny} {ipx | bpdu |
mpls-unicast | mpls-multicast | any | hex_number}
```



Note

If an EtherType access list is configured to **deny all**, all ethernet frames are discarded. Only physical protocol traffic, such as auto-negotiation, is still allowed.

When you enter the **access-list** command for a given access list name, the ACE is added to the end of the access list.



Tip

Enter the *access_list_name* in upper case letters so the name is easy to see in the configuration. You might want to name the access list for the interface (for example, INSIDE), or for the purpose (for example, MPLS or IPX).

For example, the following sample access list allows common EtherTypes originating on the inside interface:

```
hostname(config)# access-list ETHER ethertype permit ipx
hostname(config)# access-list ETHER ethertype permit bpdu
```

```
hostname(config)# access-list ETHER ethertype permit mpls-unicast
hostname(config)# access-group ETHER in interface inside
```

The following access list allows some EtherTypes through the security appliance, but denies IPX:

```
hostname(config)# access-list ETHER ethertype deny ipx
hostname(config)# access-list ETHER ethertype permit 0x1234
hostname(config)# access-list ETHER ethertype permit bpdu
hostname(config)# access-list ETHER ethertype permit mpls-unicast
hostname(config)# access-group ETHER in interface inside
hostname(config)# access-group ETHER in interface outside
```

The following access list denies traffic with EtherType 0x1256, but allows all others on both interfaces:

```
hostname(config)# access-list nonIP ethertype deny 1256
hostname(config)# access-list nonIP ethertype permit any
hostname(config)# access-group ETHER in interface inside
hostname(config)# access-group ETHER in interface outside
```

Adding a Standard Access List

Single context mode only

Standard access lists identify the destination IP addresses of OSPF routes, and can be used in a route map for OSPF redistribution. Standard access lists cannot be applied to interfaces to control traffic.

The following command adds a standard ACE. To add another ACE at the end of the access list, enter another **access-list** command specifying the same access list name. Apply the access list using the [“Adding a Route Map”](#) section on page 8-7.

To add an ACE, enter the following command:

```
hostname(config)# access-list access_list_name standard {deny | permit} {any | ip_address mask}
```

The following sample access list identifies routes to 192.168.1.0/24:

```
hostname(config)# access-list OSPF standard permit 192.168.1.0 255.255.255.0
```

To remove an ACE, enter the **no access-list** command with the entire command syntax string as it appears in the configuration:

```
hostname(config)# no access-list access_list_name standard {deny | permit} {any | ip_address mask}
```

Adding a Webtype Access List

To add an access list to the configuration that supports filtering for WebVPN, enter the following command:

```
hostname(config)# access-list access_list_name webtype {deny | permit} url [url_string | any]
```

To remove a Webtype access list, enter the **no access-list** command with the entire syntax string as it appears in the configuration:

```
hostname(config)# access-list access_list_name webtype {deny | permit} url [url_string | any]
```

For information about logging options that you can add to the end of the ACE, see the [“Logging Access List Activity”](#) section on page 13-17.

Simplifying Access Lists with Object Grouping

This section describes how to use object grouping to simplify access list creation and maintenance.

This section includes the following topics:

- [How Object Grouping Works, page 13-10](#)
- [Adding Object Groups, page 13-11](#)
- [Nesting Object Groups, page 13-14](#)
- [Displaying Object Groups, page 13-16](#)
- [Removing Object Groups, page 13-16](#)
- [Using Object Groups with an Access List, page 13-15](#)

How Object Grouping Works

By grouping like-objects together, you can use the object group in an ACE instead of having to enter an ACE for each object separately. You can create the following types of object groups:

- Protocol
- Network
- Service
- ICMP type

For example, consider the following three object groups:

- **MyServices**—Includes the TCP and UDP port numbers of the service requests that are allowed access to the internal network
- **TrustedHosts**—Includes the host and network addresses allowed access to the greatest range of services and servers
- **PublicServers**—Includes the host addresses of servers to which the greatest access is provided

After creating these groups, you could use a single ACE to allow trusted hosts to make specific service requests to a group of public servers.

You can also nest object groups in other object groups.

**Note**

The ACE system limit applies to expanded access lists. If you use object groups in ACEs, the number of actual ACEs that you enter is fewer, but the number of expanded ACEs is the same as without object groups. In many cases, object groups create more ACEs than if you added them manually, because creating ACEs manually leads you to summarize addresses more than an object group does. To view the number of expanded ACEs in an access list, enter the **show access-list** *access_list_name* command.

Adding Object Groups

This section describes how to add object groups.

This section includes the following topics:

- [Adding a Protocol Object Group, page 13-11](#)
- [Adding a Network Object Group, page 13-12](#)
- [Adding a Service Object Group, page 13-12](#)
- [Adding an ICMP Type Object Group, page 13-13](#)

Adding a Protocol Object Group

To add or change a protocol object group, follow these steps. After you add the group, you can add more objects as required by following this procedure again for the same group name and specifying additional objects. You do not need to reenter existing objects; the commands you already set remain in place unless you remove them with the **no** form of the command.

To add a protocol group, follow these steps:

Step 1 To add a protocol group, enter the following command:

```
hostname(config)# object-group protocol grp_id
```

The *grp_id* is a text string up to 64 characters in length.

The prompt changes to protocol configuration mode.

Step 2 (Optional) To add a description, enter the following command:

```
hostname(config-protocol)# description text
```

The description can be up to 200 characters.

Step 3 To define the protocols in the group, enter the following command for each protocol:

```
hostname(config-protocol)# protocol-object protocol
```

The *protocol* is the numeric identifier of the specific IP protocol (1 to 254) or a keyword identifier (for example, **icmp**, **tcp**, or **udp**). To include all IP protocols, use the keyword **ip**. For a list of protocols you can specify, see the “[Protocols and Applications](#)” section on page D-11.

For example, to create a protocol group for TCP, UDP, and ICMP, enter the following commands:

```
hostname(config)# object-group protocol tcp_udp_icmp
hostname(config-protocol)# protocol-object tcp
hostname(config-protocol)# protocol-object udp
hostname(config-protocol)# protocol-object icmp
```

Adding a Network Object Group

To add or change a network object group, follow these steps. After you add the group, you can add more objects as required by following this procedure again for the same group name and specifying additional objects. You do not need to reenter existing objects; the commands you already set remain in place unless you remove them with the **no** form of the command.



Note

A network object group supports IPv4 and IPv6 addresses, depending on the type of access list. For more information about IPv6 access lists, see “[Configuring IPv6 Access Lists](#)” section on page 9-4.

To add a network group, follow these steps:

Step 1 To add a network group, enter the following command:

```
hostname(config)# object-group network grp_id
```

The *grp_id* is a text string up to 64 characters in length.

The prompt changes to network configuration mode.

Step 2 (Optional) To add a description, enter the following command:

```
hostname(config-network)# description text
```

The description can be up to 200 characters.

Step 3 To define the networks in the group, enter the following command for each network or address:

```
hostname(config-network)# network-object {host ip_address | ip_address mask}
```

For example, to create network group that includes the IP addresses of three administrators, enter the following commands:

```
hostname(config)# object-group network admins
hostname(config-network)# description Administrator Addresses
hostname(config-network)# network-object host 10.1.1.4
hostname(config-network)# network-object host 10.1.1.78
hostname(config-network)# network-object host 10.1.1.34
```

Adding a Service Object Group

To add or change a service object group, follow these steps. After you add the group, you can add more objects as required by following this procedure again for the same group name and specifying additional objects. You do not need to reenter existing objects; the commands you already set remain in place unless you remove them with the **no** form of the command.

To add a service group, follow these steps:

Step 1 To add a service group, enter the following command:

```
hostname(config)# object-group service grp_id {tcp | udp | tcp-udp}
```

The *grp_id* is a text string up to 64 characters in length.

Specify the protocol for the services (ports) you want to add, either **tcp**, **udp**, or **tcp-udp** keywords. Enter **tcp-udp** keyword if your service uses both TCP and UDP with the same port number, for example, DNS (port 53).

The prompt changes to service configuration mode.

- Step 2** (Optional) To add a description, enter the following command:

```
hostname(config-service)# description text
```

The description can be up to 200 characters.

- Step 3** To define the ports in the group, enter the following command for each port or range of ports:

```
hostname(config-service)# port-object {eq port | range begin_port end_port}
```

For a list of permitted keywords and well-known port assignments, see the [“Protocols and Applications” section on page D-11](#).

For example, to create service groups that include DNS (TCP/UDP), LDAP (TCP), and RADIUS (UDP), enter the following commands:

```
hostname(config)# object-group service services1 tcp-udp
hostname(config-service)# description DNS Group
hostname(config-service)# port-object eq domain

hostname(config-service)# object-group service services2 udp
hostname(config-service)# description RADIUS Group
hostname(config-service)# port-object eq radius
hostname(config-service)# port-object eq radius-acct

hostname(config-service)# object-group service services3 tcp
hostname(config-service)# description LDAP Group
hostname(config-service)# port-object eq ldap
```

Adding an ICMP Type Object Group

To add or change an ICMP type object group, follow these steps. After you add the group, you can add more objects as required by following this procedure again for the same group name and specifying additional objects. You do not need to reenter existing objects; the commands you already set remain in place unless you remove them with the **no** form of the command.

To add an ICMP type group, follow these steps:

- Step 1** To add an ICMP type group, enter the following command:

```
hostname(config)# object-group icmp-type grp_id
```

The *grp_id* is a text string up to 64 characters in length.

The prompt changes to ICMP type configuration mode.

- Step 2** (Optional) To add a description, enter the following command:

```
hostname(config-icmp-type)# description text
```

The description can be up to 200 characters.

- Step 3** To define the ICMP types in the group, enter the following command for each type:

```
hostname(config-icmp-type)# icmp-object icmp_type
```

See the “ICMP Types” section on page D-15 for a list of ICMP types.

For example, to create an ICMP type group that includes echo-reply and echo (for controlling ping), enter the following commands:

```
hostname(config)# object-group icmp-type ping
hostname(config-service)# description Ping Group
hostname(config-icmp-type)# icmp-object echo
hostname(config-icmp-type)# icmp-object echo-reply
```

Nesting Object Groups

To nest an object group within another object group of the same type, first create the group that you want to nest according to the “Adding Object Groups” section on page 13-11. Then follow these steps:

Step 1 To add or edit an object group under which you want to nest another object group, enter the following command:

```
hostname(config)# object-group {{protocol | network | icmp-type} grp_id | service grp_id
{tcp | udp | tcp-udp}}
```

Step 2 To add the specified group under the object group you specified in Step 1, enter the following command:

```
hostname(config-group_type)# group-object grp_id
```

The nested group must be of the same type.

You can mix and match nested group objects and regular objects within an object group.

For example, you create network object groups for privileged users from various departments:

```
hostname(config)# object-group network eng
hostname(config-network)# network-object host 10.1.1.5
hostname(config-network)# network-object host 10.1.1.9
hostname(config-network)# network-object host 10.1.1.89

hostname(config-network)# object-group network hr
hostname(config-network)# network-object host 10.1.2.8
hostname(config-network)# network-object host 10.1.2.12

hostname(config-network)# object-group network finance
hostname(config-network)# network-object host 10.1.4.89
hostname(config-network)# network-object host 10.1.4.100
```

You then nest all three groups together as follows:

```
hostname(config)# object-group network admin
hostname(config-network)# group-object eng
hostname(config-network)# group-object hr
hostname(config-network)# group-object finance
```

You only need to specify the admin object group in your ACE as follows:

```
hostname(config)# access-list ACL_IN extended permit ip object-group admin host
209.165.201.29
```

Using Object Groups with an Access List

To use object groups in an access list, replace the normal protocol (*protocol*), network (*source_address_mask*, etc.), service (*operator port*), or ICMP type (*icmp_type*) parameter with **object-group** *grp_id* parameter.

For example, to use object groups for all available parameters in the **access-list {tcp | udp}** command, enter the following command:

```
hostname(config)# access-list access_list_name [line line_number] [extended] {deny |
permit} {tcp | udp} object-group nw_grp_id [object-group svc_grp_id] object-group
nw_grp_id [object-group svc_grp_id] [log [[level] [interval secs] | disable | default]]
[inactive | time-range time_range_name]
```

You do not have to use object groups for all parameters; for example, you can use an object group for the source address, but identify the destination address with an address and mask.

The following normal access list that does not use object groups restricts several hosts on the inside network from accessing several web servers. All other traffic is allowed.

```
hostname(config)# access-list ACL_IN extended deny tcp host 10.1.1.4 host 209.165.201.29
eq www
hostname(config)# access-list ACL_IN extended deny tcp host 10.1.1.78 host 209.165.201.29
eq www
hostname(config)# access-list ACL_IN extended deny tcp host 10.1.1.89 host 209.165.201.29
eq www
hostname(config)# access-list ACL_IN extended deny tcp host 10.1.1.4 host 209.165.201.16
eq www
hostname(config)# access-list ACL_IN extended deny tcp host 10.1.1.78 host 209.165.201.16
eq www
hostname(config)# access-list ACL_IN extended deny tcp host 10.1.1.89 host 209.165.201.16
eq www
hostname(config)# access-list ACL_IN extended deny tcp host 10.1.1.4 host 209.165.201.78
eq www
hostname(config)# access-list ACL_IN extended deny tcp host 10.1.1.78 host 209.165.201.78
eq www
hostname(config)# access-list ACL_IN extended deny tcp host 10.1.1.89 host 209.165.201.78
eq www
hostname(config)# access-list ACL_IN extended permit ip any any
hostname(config)# access-group ACL_IN in interface inside
```

If you make two network object groups, one for the inside hosts, and one for the web servers, then the configuration can be simplified and can be easily modified to add more hosts:

```
hostname(config)# object-group network denied
hostname(config-network)# network-object host 10.1.1.4
hostname(config-network)# network-object host 10.1.1.78
hostname(config-network)# network-object host 10.1.1.89

hostname(config-network)# object-group network web
hostname(config-network)# network-object host 209.165.201.29
hostname(config-network)# network-object host 209.165.201.16
hostname(config-network)# network-object host 209.165.201.78

hostname(config-network)# access-list ACL_IN extended deny tcp object-group denied
object-group web eq www
hostname(config)# access-list ACL_IN extended permit ip any any
hostname(config)# access-group ACL_IN in interface inside
```

Displaying Object Groups

To display a list of the currently configured object groups, enter the following command:

```
hostname(config)# show object-group [protocol | network | service | icmp-type | id grp_id]
```

If you enter the command without any parameters, the system displays all configured object groups.

The following is sample output from the **show object-group** command:

```
hostname# show object-group
object-group network ftp_servers
  description: This is a group of FTP servers
  network-object host 209.165.201.3
  network-object host 209.165.201.4
object-group network TrustedHosts
  network-object host 209.165.201.1
  network-object 192.168.1.0 255.255.255.0
group-object ftp_servers
```

Removing Object Groups

To remove an object group, enter one of the following commands.



Note

You cannot remove an object group or make an object group empty if it is used in an access list.

- To remove a specific object group, enter the following command:

```
hostname(config)# no object-group grp_id
```

- To remove all object groups of the specified type, enter the following command:

```
hostname(config)# clear object-group [protocol | network | services | icmp-type]
```

If you do not enter a type, all object groups are removed.

Adding Remarks to Access Lists

You can include remarks about entries in any access list, including extended, EtherType, and standard access lists. The remarks make the access list easier to understand.

To add a remark after the last **access-list** command you entered, enter the following command:

```
hostname(config)# access-list access_list_name remark text
```

If you enter the remark before any **access-list** command, then the remark is the first line in the access list.

If you delete an access list using the **no access-list access_list_name** command, then all the remarks are also removed.

The text can be up to 100 characters in length. You can enter leading spaces at the beginning of the text. Trailing spaces are ignored.

For example, you can add remarks before each ACE, and the remark appears in the access list in this location. Entering a dash (-) at the beginning of the remark helps set it apart from ACEs.

```
hostname(config)# access-list OUT remark - this is the inside admin address
hostname(config)# access-list OUT extended permit ip host 209.168.200.3 any
```

```
hostname(config)# access-list OUT remark - this is the hr admin address
hostname(config)# access-list OUT extended permit ip host 209.168.200.4 any
```

Time Range Options

To implement a time-based access list, use the **time-range** command to define specific times of the day and week. Then use the with the **access-list extended** command to bind the time range to an access list. The following example binds an access list named “Sales” to a time range named “New_York_Minute.”

```
hostname(config)# access-list Sales line 1 extended deny tcp host 209.165.200.225 host
209.165.201.1 time-range New_York_Minute
hostname(config)#
```

Refer to the **time-range** command in the *Cisco Security Appliance Command Reference* for more information about how to define a time range.

In place of the time range option, you can also choose to inactivate an ACE. Use the **inactive** keyword to disable an Access Control Element.

Logging Access List Activity

This section describes how to configure access list logging for extended access lists and Webtype access lists.

This section includes the following topics:

- [Access List Logging Overview, page 13-17](#)
- [Configuring Logging for an Access Control Entry, page 13-18](#)
- [Managing Deny Flows, page 13-19](#)

Access List Logging Overview

By default, when traffic is denied by an extended ACE or a Webtype ACE, the security appliance generates system message 106023 for each denied packet, in the following form:

```
%ASA|PIX-4-106023: Deny protocol src [interface_name:source_address/source_port] dst
interface_name:dest_address/dest_port [type {string}, code {code}] by access_group acl_id
```

If the security appliance is attacked, the number of system messages for denied packets can be very large. We recommend that you instead enable logging using system message 106100, which provides statistics for each ACE and lets you limit the number of system messages produced. Alternatively, you can disable all logging.



Note

Only ACEs in the access list generate logging messages; the implicit deny at the end of the access list does not generate a message. If you want all denied traffic to generate messages, add the implicit ACE manually to the end of the access list, as follows.

```
hostname(config)# access-list TEST deny ip any any log
```

The **log** options at the end of the extended **access-list** command lets you to set the following behavior:

- Enable message 106100 instead of message 106023
- Disable all logging
- Return to the default logging using message 106023

System message 106100 is in the following form:

```
%ASA|PIX-n-106100: access-list acl_id {permitted | denied} protocol
interface_name/source_address(source_port) -> interface_name/dest_address(dest_port)
hit-cnt number ((first hit | number-second interval))
```

When you enable logging for message 106100, if a packet matches an ACE, the security appliance creates a flow entry to track the number of packets received within a specific interval. The security appliance generates a system message at the first hit and at the end of each interval, identifying the total number of hits during the interval. At the end of each interval, the security appliance resets the hit count to 0. If no packets match the ACE during an interval, the security appliance deletes the flow entry.

A flow is defined by the source and destination IP addresses, protocols, and ports. Because the source port might differ for a new connection between the same two hosts, you might not see the same flow increment because a new flow was created for the connection. See the [“Managing Deny Flows” section on page 13-19](#) to limit the number of logging flows.

Permitted packets that belong to established connections do not need to be checked against access lists; only the initial packet is logged and included in the hit count. For connectionless protocols, such as ICMP, all packets are logged even if they are permitted, and all denied packets are logged.

See the *Cisco Security Appliance Logging Configuration and System Log Messages* for detailed information about this system message.

Configuring Logging for an Access Control Entry

To configure logging for an ACE, see the following information about the **log** option:

```
hostname(config)# access-list access_list_name [extended] {deny | permit}...[log [[level]
[interval secs] | disable | default]]
```

See the [“Adding an Extended Access List” section on page 13-5](#) and [“Adding a Webtype Access List” section on page 13-10](#) for complete **access-list** command syntax.

If you enter the **log** option without any arguments, you enable system log message 106100 at the default level (6) and for the default interval (300 seconds). See the following options:

- **level**—A severity level between 0 and 7. The default is 6.
- **interval secs**—The time interval in seconds between system messages, from 1 to 600. The default is 300. This value is also used as the timeout value for deleting an inactive flow.
- **disable**—Disables all access list logging.

default—Enables logging to message 106023. This setting is the same as having no **log** option.

For example, you configure the following access list:

```
hostname(config)# access-list outside-acl permit ip host 1.1.1.1 any log 7 interval 600
hostname(config)# access-list outside-acl permit ip host 2.2.2.2 any
hostname(config)# access-list outside-acl deny ip any any log 2
hostname(config)# access-group outside-acl in interface outside
```

When a packet is permitted by the first ACE of `outside-acl`, the security appliance generates the following system message:

```
%ASA|PIX-7-106100: access-list outside-acl permitted tcp outside/1.1.1.1(12345) ->
inside/192.168.1.1(1357) hit-cnt 1 (first hit)
```

Although 20 additional packets for this connection arrive on the outside interface, the traffic does not have to be checked against the access list, and the hit count does not increase.

If one more connection by the same host is initiated within the specified 10 minute interval (and the source and destination ports remain the same), then the hit count is incremented by 1 and the following message is displayed at the end of the 10 minute interval:

```
%ASA|PIX-7-106100: access-list outside-acl permitted tcp outside/1.1.1.1(12345)->
inside/192.168.1.1(1357) hit-cnt 2 (600-second interval)
```

When a packet is denied by the third ACE, then the security appliance generates the following system message:

```
%ASA|PIX-2-106100: access-list outside-acl denied ip outside/3.3.3.3(12345) ->
inside/192.168.1.1(1357) hit-cnt 1 (first hit)
```

20 additional attempts within a 5 minute interval (the default) result in the following message at the end of 5 minutes:

```
%ASA|PIX-2-106100: access-list outside-acl denied ip outside/3.3.3.3(12345) ->
inside/192.168.1.1(1357) hit-cnt 21 (300-second interval)
```

Managing Deny Flows

When you enable logging for message 106100, if a packet matches an ACE, the security appliance creates a flow entry to track the number of packets received within a specific interval. The security appliance has a maximum of 32 K logging flows for ACEs. A large number of flows can exist concurrently at any point of time. To prevent unlimited consumption of memory and CPU resources, the security appliance places a limit on the number of concurrent *deny* flows; the limit is placed only on deny flows (and not permit flows) because they can indicate an attack. When the limit is reached, the security appliance does not create a new deny flow for logging until the existing flows expire.

For example, if someone initiates a DoS attack, the security appliance can create a large number of deny flows in a short period of time. Restricting the number of deny flows prevents unlimited consumption of memory and CPU resources.

When you reach the maximum number of deny flows, the security appliance issues system message 106101:

```
%ASA|PIX-1-106101: The number of ACL log deny-flows has reached limit (number).
```

To configure the maximum number of deny flows and to set the interval between deny flow alert messages (106101), enter the following commands:

- To set the maximum number of deny flows permitted per context before the security appliance stops logging, enter the following command:

```
hostname(config)# access-list deny-flow-max number
```

The *number* is between 1 and 4096. 4096 is the default.

- To set the amount of time between system messages (number 106101) that identify that the maximum number of deny flows was reached, enter the following command:

```
hostname(config)# access-list alert-interval secs
```

The *seconds* are between 1 and 3600, and 300 is the default.



Applying NAT

This chapter describes Network Address Translation (NAT). In routed firewall mode, the security appliance can perform NAT between each network.



Note

In transparent firewall mode, the security appliance does not support NAT.

This chapter contains the following sections:

- [NAT Overview, page 14-21](#)
- [Configuring NAT Control, page 14-36](#)
- [Using Dynamic NAT and PAT, page 14-37](#)
- [Using Static NAT, page 14-46](#)
- [Using Static PAT, page 14-47](#)
- [Bypassing NAT, page 14-49](#)
- [NAT Examples, page 14-53](#)

NAT Overview

This section describes how NAT works on the security appliance, and includes the following topics:

- [Introduction to NAT, page 14-22](#)
- [NAT Control, page 14-23](#)
- [NAT Types, page 14-25](#)
- [Policy NAT, page 14-29](#)
- [NAT and Same Security Level Interfaces, page 14-33](#)
- [Order of NAT Commands Used to Match Real Addresses, page 14-34](#)
- [Mapped Address Guidelines, page 14-34](#)
- [DNS and NAT, page 14-34](#)

Introduction to NAT

Address translation substitutes the real address in a packet with a mapped address that is routable on the destination network. NAT is comprised of two steps: the process in which a real address is translated into a mapped address, and then the process to undo translation for returning traffic.

The security appliance translates an address when a NAT rule matches the traffic. If no NAT rule matches, processing for the packet continues. The exception is when you enable NAT control. NAT control requires that packets traversing from a higher security interface (inside) to a lower security interface (outside) match a NAT rule, or else processing for the packet stops. (See the [“Security Level Overview”](#) section on page 6-1 for more information about security levels, and see [“NAT Control”](#) section on page 14-23 for more information about NAT control).

**Note**

In this document, all types of translation are generally referred to as NAT. When discussing NAT, the terms *inside* and *outside* are relative, and represent the security relationship between any two interfaces. The higher security level is inside and the lower security level is outside; for example, interface 1 is at 60 and interface 2 is at 50, so interface 1 is “inside” and interface 2 is “outside.”

Some of the benefits of NAT are as follows:

- You can use private addresses on your inside networks. Private addresses are not routable on the Internet. (See the [“Private Networks”](#) section on page D-2 for more information.)
- NAT hides the real addresses from other networks, so attackers cannot learn the real address of a host.
- You can resolve IP routing problems such as overlapping addresses.

**Note**

See [Table 21-1 on page 21-4](#) for information about protocols that do not support NAT.

[Figure 14-1](#) shows a typical NAT scenario, with a private network on the inside. When the inside host at 10.1.2.27 sends a packet to a web server, the real source address, 10.1.2.27, of the packet is changed to a mapped address, 209.165.201.10. When the server responds, it sends the response to the mapped address, 209.165.201.10, and the security appliance receives the packet. The security appliance then undoes the translation of the mapped address, 209.165.201.10 back to the real address, 10.1.2.27 before sending it on to the host.

Figure 14-1 NAT Example

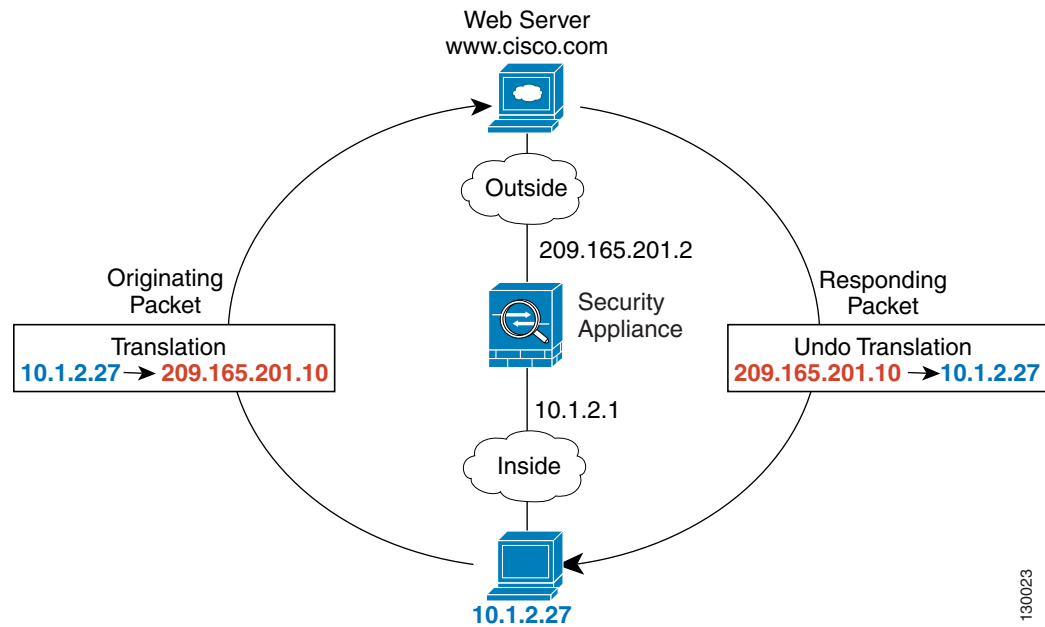

130023

See the following commands for this example:

```
hostname(config)# nat (inside) 1 10.1.2.0 255.255.255.0
hostname(config)# global (outside) 1 209.165.201.1-209.165.201.15
```

NAT Control

NAT control requires that packets traversing from an inside interface to an outside interface match a NAT rule; for any host on the inside network to access a host on the outside network, you must configure NAT to translate the inside host address (see Figure 14-2).

Figure 14-2 NAT Control and Outbound Traffic

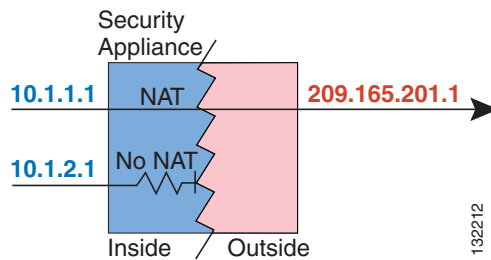

132212

Interfaces at the same security level are not required to use NAT to communicate. However, if you configure dynamic NAT or PAT on a same security interface, then all traffic from the interface to a same security interface or an outside interface must match a NAT rule (see [Figure 14-3](#)).

Figure 14-3 NAT Control and Same Security Traffic

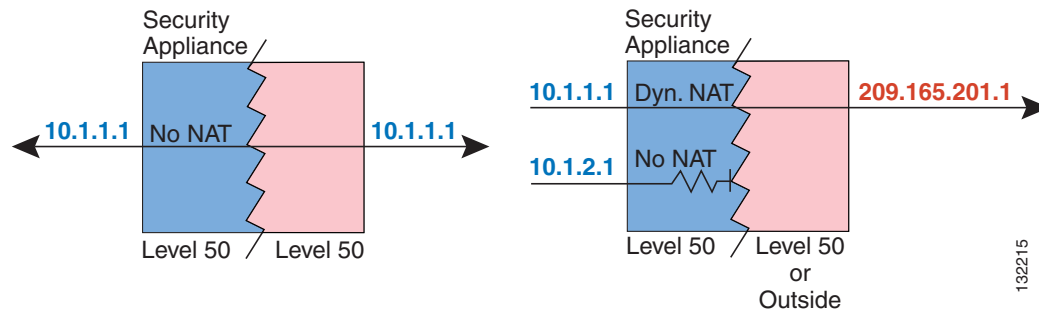

Similarly, if you enable outside dynamic NAT or PAT, then all outside traffic must match a NAT rule when it accesses an inside interface (see [Figure 14-4](#)).

Figure 14-4 NAT Control and Inbound Traffic

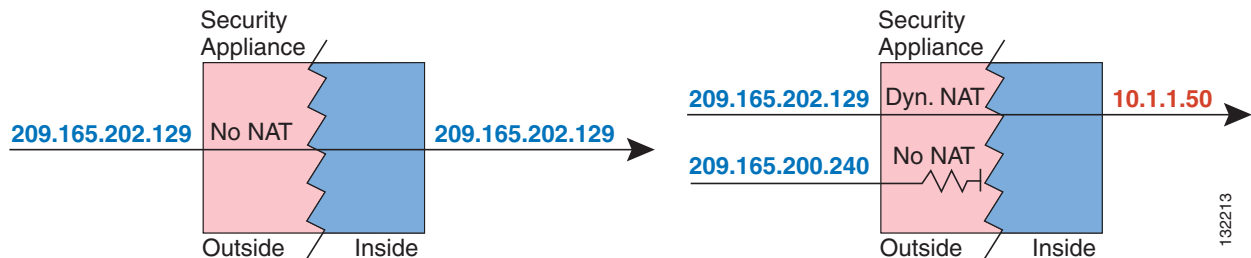

Static NAT does not cause these restrictions.

By default, NAT control is disabled, so you do not need to perform NAT on any networks unless you choose to perform NAT. If you upgraded from an earlier version of software, however, NAT control might be enabled on your system.

If you want the added security of NAT control but do not want to translate inside addresses in some cases, you can apply a NAT exemption or identity NAT rule on those addresses. (See the [“Bypassing NAT” section on page 14-49](#) for more information).

To configure NAT control, see the [“Configuring NAT Control” section on page 14-36](#).



Note

In multiple context mode, the packet classifier relies on the NAT configuration in some cases to assign packets to contexts. If you do not perform NAT because NAT control is disabled, then the classifier might require changes in your network configuration. See the [“How the Security Appliance Classifies Packets” section on page 3-3](#) for more information about the relationship between the classifier and NAT.

NAT Types

This section describes the available NAT types. You can implement address translation as dynamic NAT, Port Address Translation, static NAT, or static PAT or as a mix of these types. You can also configure rules to bypass NAT, for example, if you enable NAT control but do not want to perform NAT. This section includes the following topics:

- [Dynamic NAT, page 14-25](#)
- [PAT, page 14-26](#)
- [Static NAT, page 14-27](#)
- [Static PAT, page 14-27](#)
- [Bypassing NAT when NAT Control is Enabled, page 14-28](#)

Dynamic NAT

Dynamic NAT translates a group of real addresses to a pool of mapped addresses that are routable on the destination network. The mapped pool can include fewer addresses than the real group. When a host you want to translate accesses the destination network, the security appliance assigns it an IP address from the mapped pool. The translation is added only when the real host initiates the connection. The translation is in place only for the duration of the connection, and a given user does not keep the same IP address after the translation times out (see the **timeout xlate** command in the *Cisco Security Appliance Command Reference*). Users on the destination network, therefore, cannot reliably initiate a connection to a host that uses dynamic NAT (even if the connection is allowed by an access list), and the security appliance rejects any attempt to connect to a real host address directly. See the following “[Static NAT](#)” or “[Static PAT](#)” sections for reliable access to hosts.

Figure 14-5 shows a remote host attempting to connect to the real address. The connection is denied because the security appliance only allows returning connections to the mapped address.

Figure 14-5 Remote Host Attempts to Connect to the Real Address

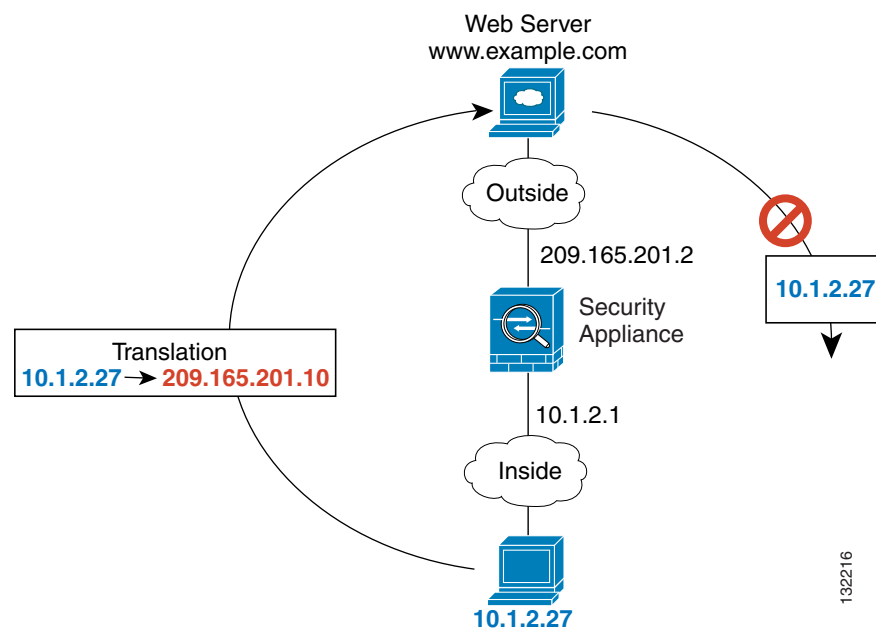
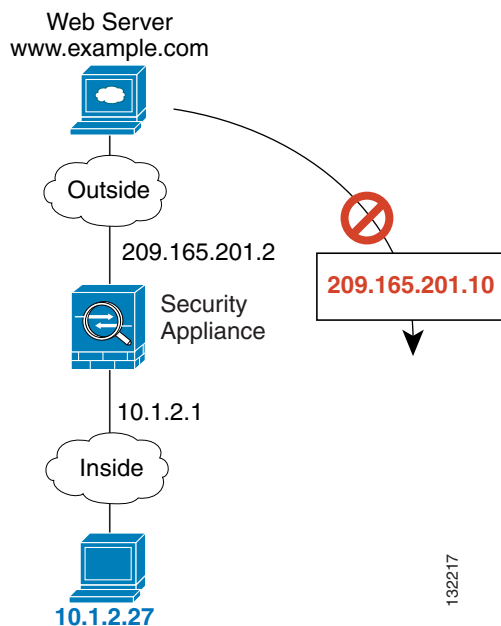

Figure 14-6 shows a remote host attempting to initiate a connection to a mapped address. This address is not currently in the translation table, so the security appliance drops the packet.

Figure 14-6 Remote Host Attempts to Initiate a Connection to a Mapped Address



Note

For the duration of the translation, a remote host can initiate a connection to the translated host if an access list allows it. Because the address is unpredictable, a connection to the host is unlikely. However in this case, you can rely on the security of the access list.

Dynamic NAT has these disadvantages:

- If the mapped pool has fewer addresses than the real group, you could run out of addresses if the amount of traffic is more than expected.
Use PAT if this event occurs often, because PAT provides over 64,000 translations using ports of a single address.
- You have to use a large number of routable addresses in the mapped pool; if the destination network requires registered addresses, such as the Internet, you might encounter a shortage of usable addresses.

The advantage of dynamic NAT is that some protocols cannot use PAT. For example, PAT does not work with IP protocols that do not have a port to overload, such as GRE version 0. PAT also does not work with some applications that have a data stream on one port and the control path on another and are not open standard, such as some multimedia applications. See the [“Application Inspection Engines” section on page 21-1](#) for more information about NAT and PAT support.

PAT

PAT translates multiple real addresses to a single mapped IP address. Specifically, the security appliance translates the real address and source port (real socket) to the mapped address and a unique port above 1024 (mapped socket). Each connection requires a separate translation, because the source port differs for each connection. For example, 10.1.1.1:1025 requires a separate translation from 10.1.1.1:1026.

After the connection expires, the port translation also expires after 30 seconds of inactivity. The timeout is not configurable. Users on the destination network cannot reliably initiate a connection to a host that uses PAT (even if the connection is allowed by an access list). Not only can you not predict the real or mapped port number of the host, but the security appliance does not create a translation at all unless the translated host is the initiator. See the following “[Static NAT](#)” or “[Static PAT](#)” sections for reliable access to hosts.

PAT lets you use a single mapped address, thus conserving routable addresses. You can even use the security appliance interface IP address as the PAT address. PAT does not work with some multimedia applications that have a data stream that is different from the control path. See the “[Application Inspection Engines](#)” section on page 21-1 for more information about NAT and PAT support.

**Note**

For the duration of the translation, a remote host can initiate a connection to the translated host if an access list allows it. Because the port address (both real and mapped) is unpredictable, a connection to the host is unlikely. However in this case, you can rely on the security of the access list.

Static NAT

Static NAT creates a fixed translation of real address(es) to mapped address(es). With dynamic NAT and PAT, each host uses a different address or port for each subsequent translation. Because the mapped address is the same for each consecutive connection with static NAT, and a persistent translation rule exists, static NAT allows hosts on the destination network to initiate traffic to a translated host (if there is an access list that allows it).

The main difference between dynamic NAT and a range of addresses for static NAT is that static NAT allows a remote host to initiate a connection to a translated host (if there is an access list that allows it), while dynamic NAT does not. You also need an equal number of mapped addresses as real addresses with static NAT.

Static PAT

Static PAT is the same as static NAT, except it lets you specify the protocol (TCP or UDP) and port for the real and mapped addresses.

This feature lets you identify the same mapped address across many different static statements, so long as the port is different for each statement (you cannot use the same mapped address for multiple static NAT statements).

For applications that require application inspection for secondary channels (FTP, VoIP, etc.), the security appliance automatically translates the secondary ports.

For example, if you want to provide a single address for remote users to access FTP, HTTP, and SMTP, but these are all actually different servers on the real network, you can specify static PAT statements for each server that uses the same mapped IP address, but different ports (see Figure 14-7).

Figure 14-7 Static PAT

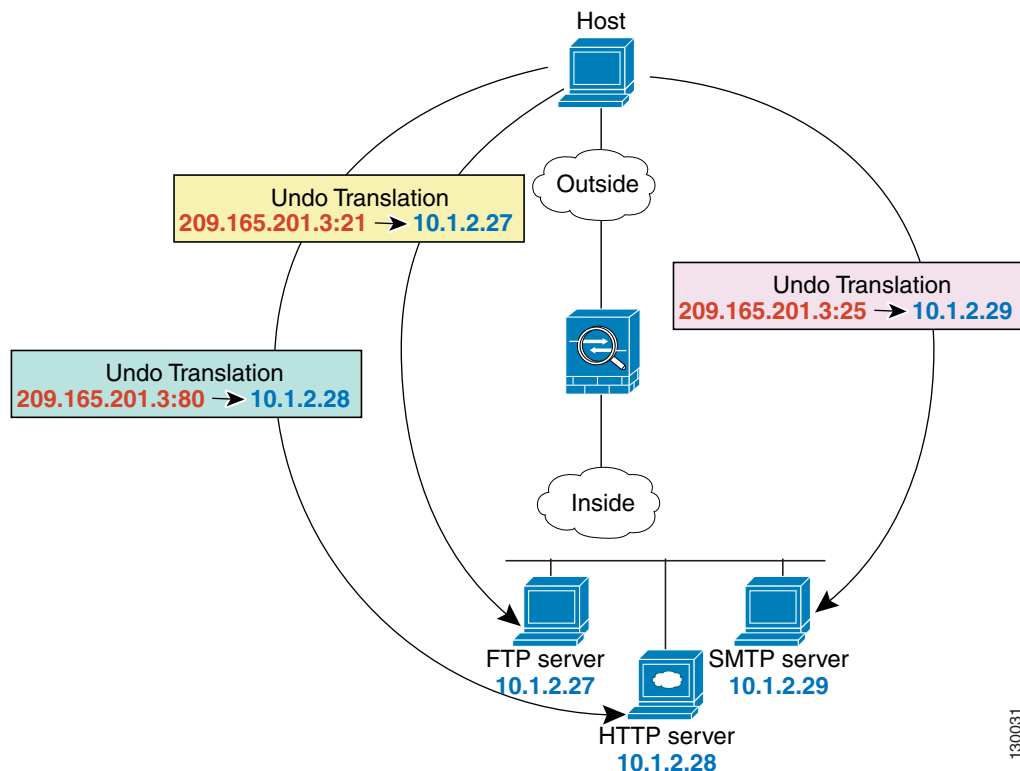

See the following commands for this example:

```
hostname(config)# static (inside,outside) tcp 209.165.201.3 ftp 10.1.2.27 ftp netmask
255.255.255.255
hostname(config)# static (inside,outside) tcp 209.165.201.3 http 10.1.2.28 http netmask
255.255.255.255
hostname(config)# static (inside,outside) tcp 209.165.201.3 smtp 10.1.2.29 smtp netmask
255.255.255.255
```

You can also use static PAT to translate a well-known port to a non-standard port or vice versa. For example, if your inside web servers use port 8080, you can allow outside users to connect to port 80, and then undo translation to the original port 8080. Similarly, if you want to provide extra security, you can tell your web users to connect to non-standard port 6785, and then undo translation to port 80.

Bypassing NAT when NAT Control is Enabled

If you enable NAT control, then inside hosts must match a NAT rule when accessing outside hosts. If you do not want to perform NAT for some hosts, then you can bypass NAT for those hosts (alternatively, you can disable NAT control). You might want to bypass NAT, for example, if you are using an application that does not support NAT (see the “[Application Inspection Engines](#)” section on page 21-1 for information about inspection engines that do not support NAT).

You can configure traffic to bypass NAT using one of three methods. All methods achieve compatibility with inspection engines. However, each method offers slightly different capabilities, as follows:

- Identity NAT (**nat 0** command)—When you configure identity NAT (which is similar to dynamic NAT), you do not limit translation for a host on specific interfaces; you must use identity NAT for connections through all interfaces. Therefore, you cannot choose to perform normal translation on real addresses when you access interface A, but use identity NAT when accessing interface B. Regular dynamic NAT, on the other hand, lets you specify a particular interface on which to translate the addresses. Make sure that the real addresses for which you use identity NAT are routable on all networks that are available according to your access lists.

For identity NAT, even though the mapped address is the same as the real address, you cannot initiate a connection from the outside to the inside (even if the interface access list allows it). Use static identity NAT or NAT exemption for this functionality.

- Static identity NAT (**static** command)—Static identity NAT lets you specify the interface on which you want to allow the real addresses to appear, so you can use identity NAT when you access interface A, and use regular translation when you access interface B. Static identity NAT also lets you use policy NAT, which identifies the real and destination addresses when determining the real addresses to translate (see the “Policy NAT” section on page 14-29 for more information about policy NAT). For example, you can use static identity NAT for an inside address when it accesses the outside interface and the destination is server A, but use a normal translation when accessing the outside server B.
- NAT exemption (**nat 0 access-list** command)—NAT exemption allows both translated and remote hosts to initiate connections. Like identity NAT, you do not limit translation for a host on specific interfaces; you must use NAT exemption for connections through all interfaces. However, NAT exemption does let you specify the real and destination addresses when determining the real addresses to translate (similar to policy NAT), so you have greater control using NAT exemption. However unlike policy NAT, NAT exemption does not consider the ports in the access list.

Policy NAT

Policy NAT lets you identify real addresses for address translation by specifying the source and destination addresses in an extended access list. You can also optionally specify the source and destination ports. Regular NAT can only consider the real addresses. For example, you can use translate the real address to mapped address A when it accesses server A, but translate the real address to mapped address B when it accesses server B.

When you specify the ports in policy NAT for applications that require application inspection for secondary channels (FTP, VoIP, etc.), the security appliance automatically translates the secondary ports.



Note

All types of NAT support policy NAT except for NAT exemption. NAT exemption uses an access list to identify the real addresses, but differs from policy NAT in that the ports are not considered. See the “Bypassing NAT” section on page 14-49 for other differences. You can accomplish the same result as NAT exemption using static identity NAT, which does support policy NAT.

Figure 14-8 shows a host on the 10.1.2.0/24 network accessing two different servers. When the host accesses the server at 209.165.201.11, the real address is translated to 209.165.202.129. When the host accesses the server at 209.165.200.225, the real address is translated to 209.165.202.130 so that the host appears to be on the same network as the servers, which can help with routing.

Figure 14-8 Policy NAT with Different Destination Addresses

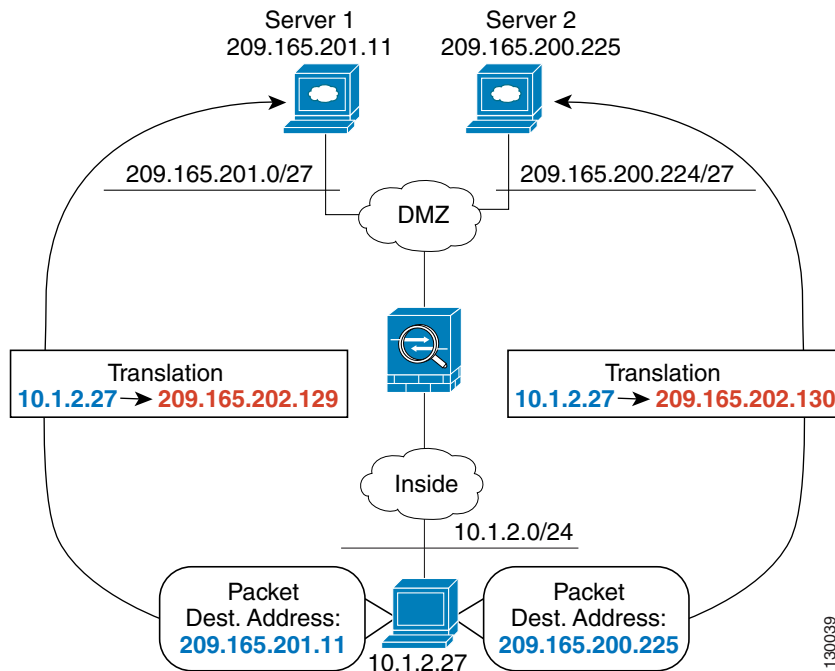

See the following commands for this example:

```
hostname(config)# access-list NET1 permit ip 10.1.2.0 255.255.255.0 209.165.201.0
255.255.255.224
hostname(config)# access-list NET2 permit ip 10.1.2.0 255.255.255.0 209.165.200.224
255.255.255.224
hostname(config)# nat (inside) 1 access-list NET1
hostname(config)# global (outside) 1 209.165.202.129
hostname(config)# nat (inside) 2 access-list NET2
hostname(config)# global (outside) 2 209.165.202.130
```

Figure 14-9 shows the use of source and destination ports. The host on the 10.1.2.0/24 network accesses a single host for both web services and Telnet services. When the host accesses the server for web services, the real address is translated to 209.165.202.129. When the host accesses the same server for Telnet services, the real address is translated to 209.165.202.130.

Figure 14-9 Policy NAT with Different Destination Ports

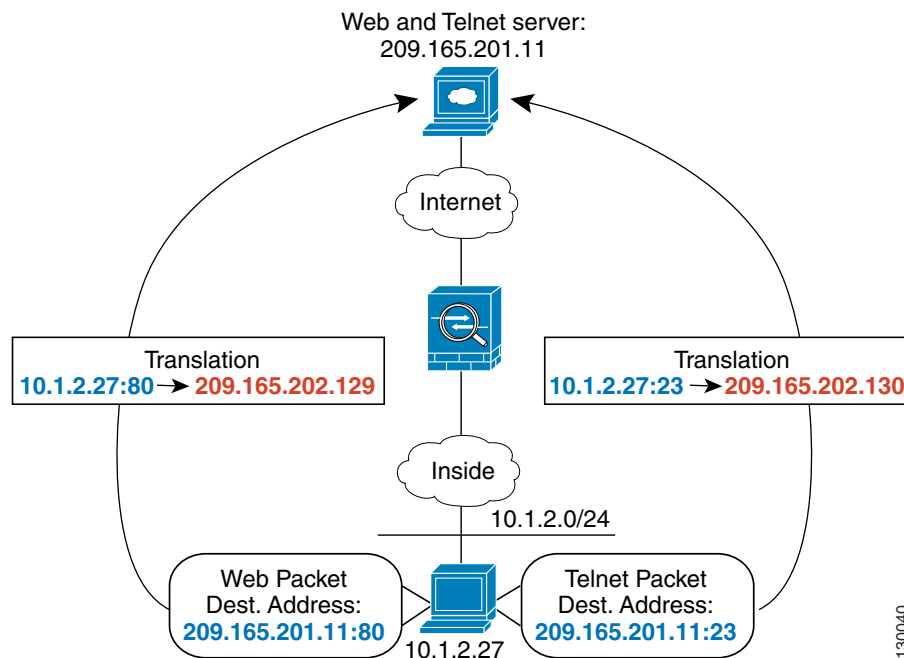

See the following commands for this example:

```
hostname(config)# access-list WEB permit tcp 10.1.2.0 255.255.255.0 209.165.201.11
255.255.255.255 eq 80
hostname(config)# access-list TELNET permit tcp 10.1.2.0 255.255.255.0 209.165.201.11
255.255.255.255 eq 23
hostname(config)# nat (inside) 1 access-list WEB
hostname(config)# global (outside) 1 209.165.202.129
hostname(config)# nat (inside) 2 access-list TELNET
hostname(config)# global (outside) 2 209.165.202.130
```

For policy static NAT (and for NAT exemption, which also uses an access list to identify traffic), both translated and remote hosts can originate traffic. For traffic originated on the translated network, the NAT access list specifies the real addresses and the *destination* addresses, but for traffic originated on the remote network, the access list identifies the real addresses and the *source* addresses of remote hosts who are allowed to connect to the host using this translation.

Figure 14-10 shows a remote host connecting to a translated host. The translated host has a policy static NAT translation that translates the real address only for traffic to and from the 209.165.201.0/27 network. A translation does not exist for the 209.165.200.224/27 network, so the translated host cannot connect to that network, nor can a host on that network connect to the translated host.

Figure 14-10 Policy Static NAT with Destination Address Translation

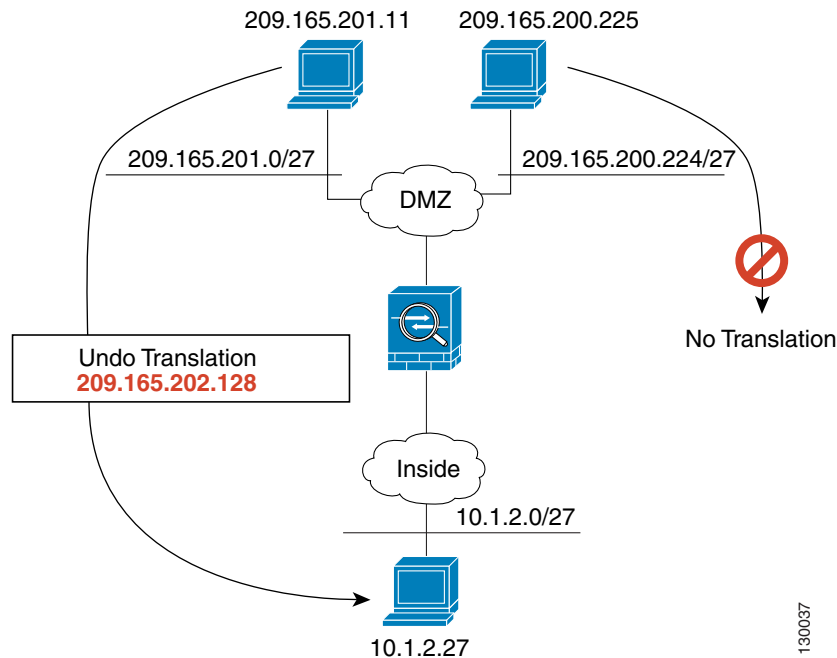

See the following commands for this example:

```
hostname(config)# access-list NET1 permit ip 10.1.2.0 255.255.255.224 209.165.201.0
255.255.255.224
hostname(config)# static (inside,outside) 209.165.202.129 access-list NET1
```



Note

For policy static NAT, in undoing the translation, the ACL in the **static** command is not used. If the destination address in the packet matches the mapped address in the static rule, the static rule is used to untranslate the address.



Note

Policy NAT does not support SQL*Net, but it is supported by regular NAT. See the [“Application Inspection Engines”](#) section on page 21-1 for information about NAT support for other protocols.

You cannot use policy static NAT to translate different real addresses to the same mapped address. For example, Figure 14-11 shows two inside hosts, 10.1.1.1 and 10.1.1.2, that you want to be translated to 209.165.200.225. When outside host 209.165.201.1 connects to 209.165.200.225, then the connection goes to 10.1.1.1. When outside host 209.165.201.2 connects to the same mapped address, 209.165.200.225, you want the connection to go to 10.1.1.2. However, only one source address in the access list can be used. Since the first ACE is for 10.1.1.1, then all inbound connections sourced from 209.165.201.1 and 209.165.201.2 and destined to 209.165.200.225 will have their destination address translated to 10.1.1.1.

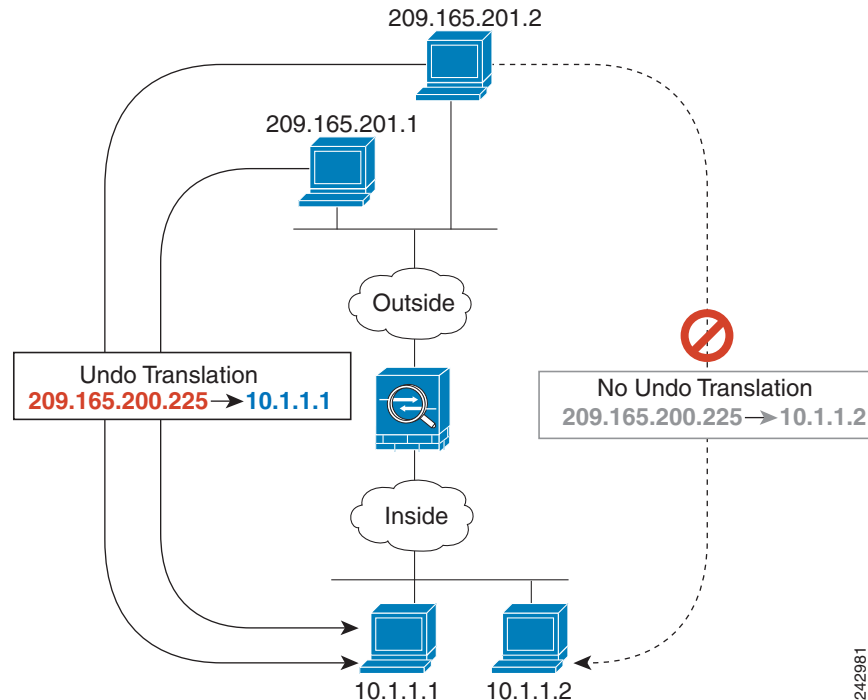
Figure 14-11 Real Addresses Cannot Share the Same Mapped Address

See the following commands for this example. (Although the second ACE in the example does allow 209.165.201.2 to connect to 209.165.200.225, it only allows 209.165.200.225 to be translated to 10.1.1.1.)

```
hostname(config)# static (in,out) 209.165.200.225 access-list policy-nat
hostname(config)# access-list policy-nat permit ip host 10.1.1.1 host 209.165.201.1
hostname(config)# access-list policy-nat permit ip host 10.1.1.2 host 209.165.201.2
```

242981

NAT and Same Security Level Interfaces

NAT is not required between same security level interfaces even if you enable NAT control. You can optionally configure NAT if desired. However, if you configure dynamic NAT when NAT control is enabled, then NAT is required. See the “[NAT Control](#)” section on page 14-23 for more information. Also, when you specify a group of IP address(es) for dynamic NAT or PAT on a same security interface, then you must perform NAT on that group of addresses when they access any lower or same security level interface (even when NAT control is not enabled). Traffic identified for static NAT is not affected.

See the “[Allowing Communication Between Interfaces on the Same Security Level](#)” section on page 6-5 to enable same security communication.



Note

The security appliance does not support VoIP inspection engines when you configure NAT on same security interfaces. These inspection engines include Skinny, SIP, and H.323. See the “[Application Inspection Engines](#)” section on page 21-1 for supported inspection engines.

Order of NAT Commands Used to Match Real Addresses

The security appliance matches real addresses to NAT commands in the following order:

1. NAT exemption (**nat 0 access-list**)—In order, until the first match. Identity NAT is not included in this category; it is included in the regular static NAT or regular NAT category. We do not recommend overlapping addresses in NAT exemption statements because unexpected results can occur.
2. Static NAT and Static PAT (regular and policy) (**static**)—In order, until the first match. Static identity NAT is included in this category.
3. Policy dynamic NAT (**nat access-list**)—In order, until the first match. Overlapping addresses are allowed.
4. Regular dynamic NAT (**nat**)—Best match. Regular identity NAT is included in this category. The order of the NAT commands does not matter; the NAT statement that best matches the real address is used. For example, you can create a general statement to translate all addresses (0.0.0.0) on an interface. If you want to translate a subset of your network (10.1.1.1) to a different address, then you can create a statement to translate only 10.1.1.1. When 10.1.1.1 makes a connection, the specific statement for 10.1.1.1 is used because it matches the real address best. We do not recommend using overlapping statements; they use more memory and can slow the performance of the security appliance.

Mapped Address Guidelines

When you translate the real address to a mapped address, you can use the following mapped addresses:

- Addresses on the same network as the mapped interface.
If you use addresses on the same network as the mapped interface (through which traffic exits the security appliance), the security appliance uses proxy ARP to answer any requests for mapped addresses, and thus intercepts traffic destined for a real address. This solution simplifies routing, because the security appliance does not have to be the gateway for any additional networks. However, this approach does put a limit on the number of available addresses used for translations. For PAT, you can even use the IP address of the mapped interface.
- Addresses on a unique network.
If you need more addresses than are available on the mapped interface network, you can identify addresses on a different subnet. The security appliance uses proxy ARP to answer any requests for mapped addresses, and thus intercepts traffic destined for a real address. If you use OSPF, and you advertise routes on the mapped interface, then the security appliance advertises the mapped addresses. If the mapped interface is passive (not advertising routes) or you are using static routing, then you need to add a static route on the upstream router that sends traffic destined for the mapped addresses to the security appliance.

DNS and NAT

You might need to configure the security appliance to modify DNS replies by replacing the address in the reply with an address that matches the NAT configuration. You can configure DNS modification when you configure each translation.

For example, a DNS server is accessible from the outside interface. A server, ftp.cisco.com, is on the inside interface. You configure the security appliance to statically translate the ftp.cisco.com real address (10.1.3.14) to a mapped address (209.165.201.10) that is visible on the outside network (see

Figure 14-12). In this case, you want to enable DNS reply modification on this static statement so that inside users who have access to ftp.cisco.com using the real address receive the real address from the DNS server, and not the mapped address.

When an inside host sends a DNS request for the address of ftp.cisco.com, the DNS server replies with the mapped address (209.165.201.10). The security appliance refers to the static statement for the inside server and translates the address inside the DNS reply to 10.1.3.14. If you do not enable DNS reply modification, then the inside host attempts to send traffic to 209.165.201.10 instead of accessing ftp.cisco.com directly.

Figure 14-12 DNS Reply Modification

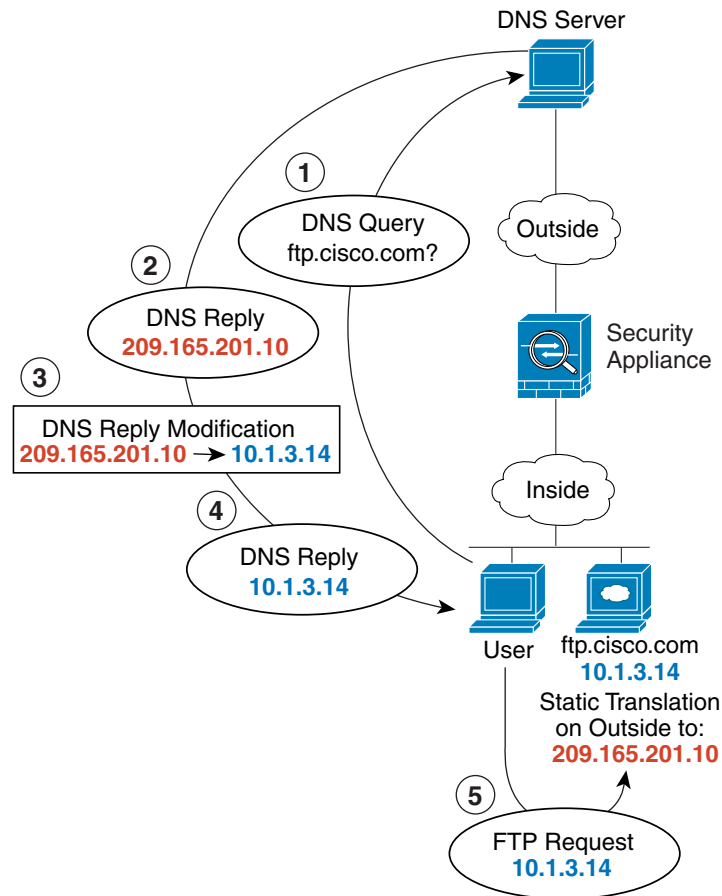

See the following command for this example:

```
hostname(config)# static (inside,outside) 209.165.201.10 10.1.3.14 netmask 255.255.255.255
dns
```

130021

Figure 14-13 shows a web server and DNS server on the outside. The security appliance has a static translation for the outside server. In this case, when an inside user requests the address for ftp.cisco.com from the DNS server, the DNS server responds with the real address, 209.165.201.10. Because you want inside users to use the mapped address for ftp.cisco.com (10.1.2.56) you need to configure DNS reply modification for the static translation.

Figure 14-13 DNS Reply Modification Using Outside NAT

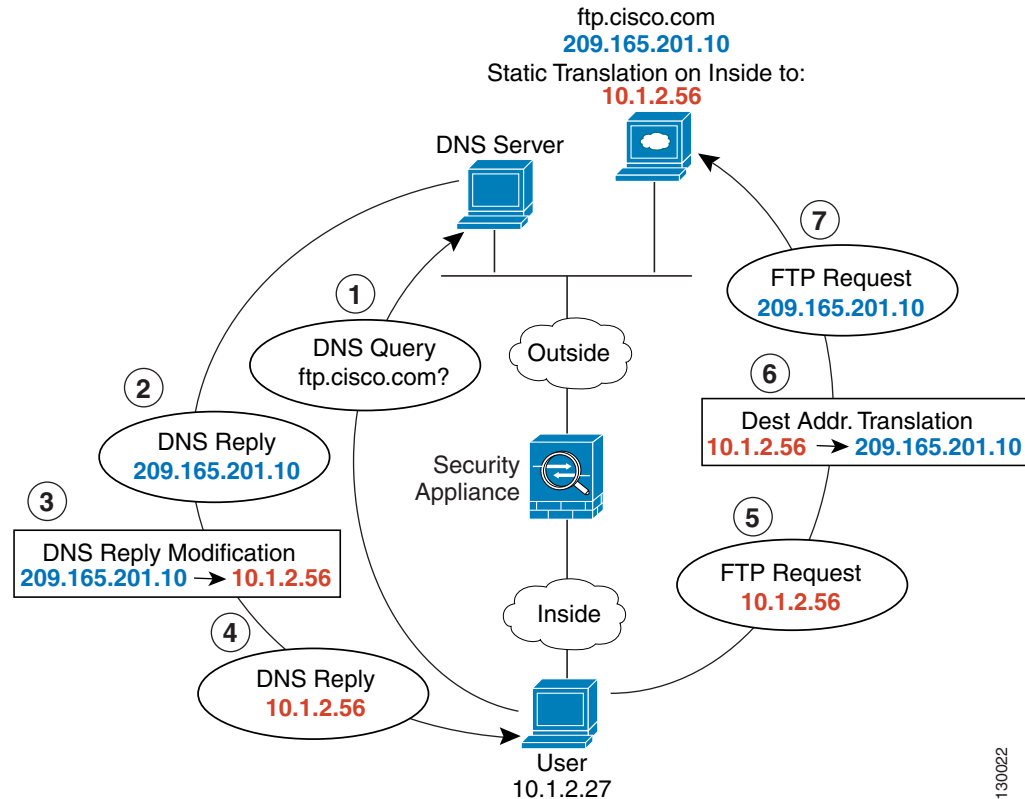

See the following command for this example:

```
hostname(config)# static (outside,inside) 10.1.2.56 209.165.201.10 netmask 255.255.255.255 dns
```

Configuring NAT Control

NAT control requires that packets traversing from an inside interface to an outside interface match a NAT rule. See the “NAT Control” section on page 14-23 for more information.

To enable NAT control, enter the following command:

```
hostname(config)# nat-control
```

To disable NAT control, enter the **no** form of the command.

Using Dynamic NAT and PAT

This section describes how to configure dynamic NAT and PAT, and includes the following topics:

- [Dynamic NAT and PAT Implementation, page 14-37](#)
- [Configuring Dynamic NAT or PAT, page 14-43](#)

Dynamic NAT and PAT Implementation

For dynamic NAT and PAT, you first configure a **nat** command identifying the real addresses on a given interface that you want to translate. Then you configure a separate **global** command to specify the mapped addresses when exiting another interface (in the case of PAT, this is one address). Each **nat** command matches a **global** command by comparing the NAT ID, a number that you assign to each command (see [Figure 14-14](#)).

Figure 14-14 *nat and global ID Matching*

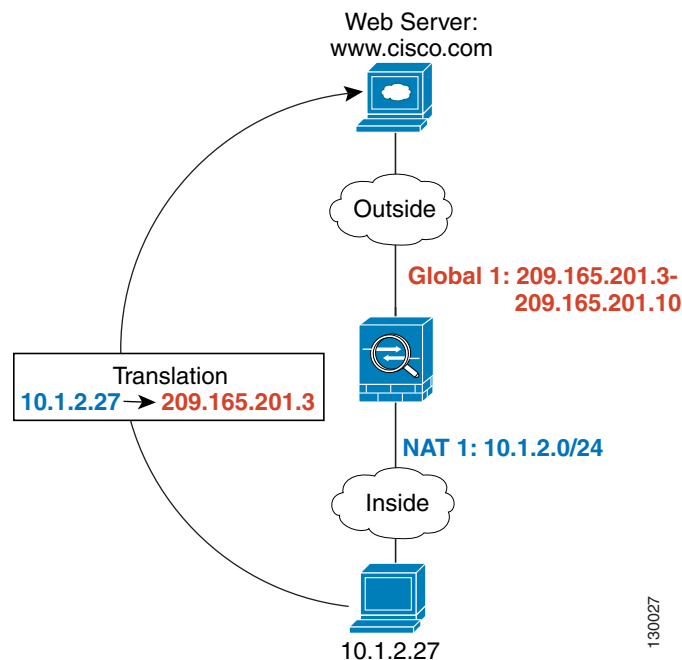

See the following commands for this example:

```
hostname(config)# nat (inside) 1 10.1.2.0 255.255.255.0
hostname(config)# global (outside) 1 209.165.201.3-209.165.201.10
```

You can enter a **nat** command for each interface using the same NAT ID; they all use the same **global** command when traffic exits a given interface. For example, you can configure **nat** commands for Inside and DMZ interfaces, both on NAT ID 1. Then you configure a **global** command on the Outside interface that is also on ID 1. Traffic from the Inside interface and the DMZ interface share a mapped pool or a PAT address when exiting the Outside interface (see Figure 14-15).

Figure 14-15 *nat Commands on Multiple Interfaces*

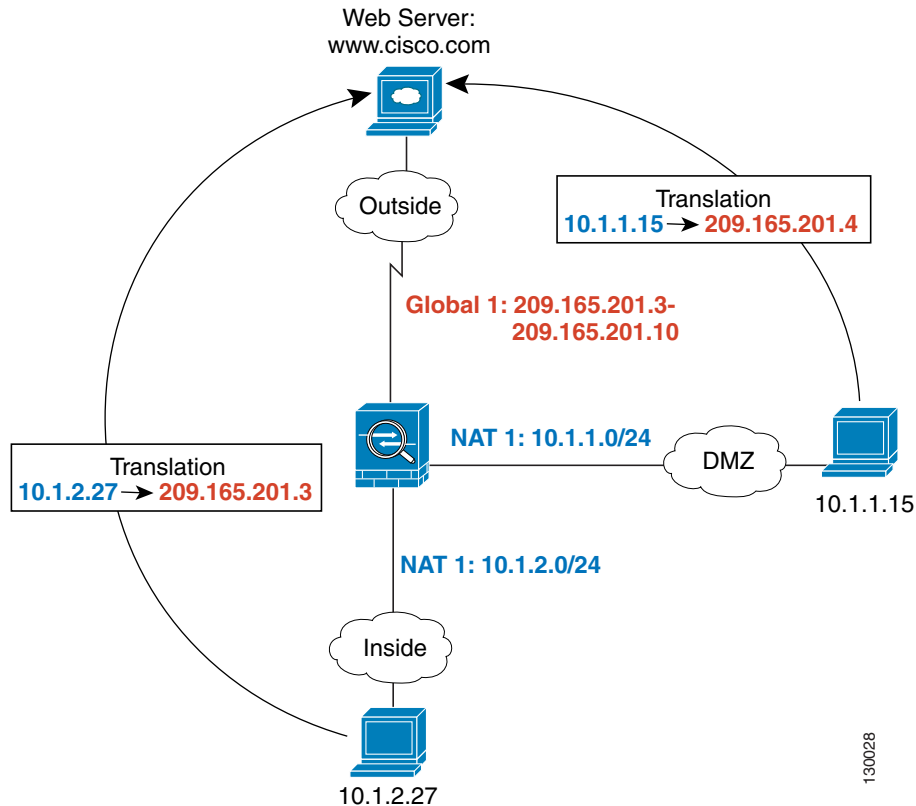

See the following commands for this example:

```
hostname(config)# nat (inside) 1 10.1.2.0 255.255.255.0
hostname(config)# nat (dmz) 1 10.1.1.0 255.255.255.0
hostname(config)# global (outside) 1 209.165.201.3-209.165.201.10
```

You can also enter a **global** command for each interface using the same NAT ID. If you enter a **global** command for the Outside and DMZ interfaces on ID 1, then the Inside **nat** command identifies traffic to be translated when going to both the Outside and the DMZ interfaces. Similarly, if you also enter a **nat** command for the DMZ interface on ID 1, then the **global** command on the Outside interface is also used for DMZ traffic. (See Figure 14-16).

Figure 14-16 *global and nat Commands on Multiple Interfaces*

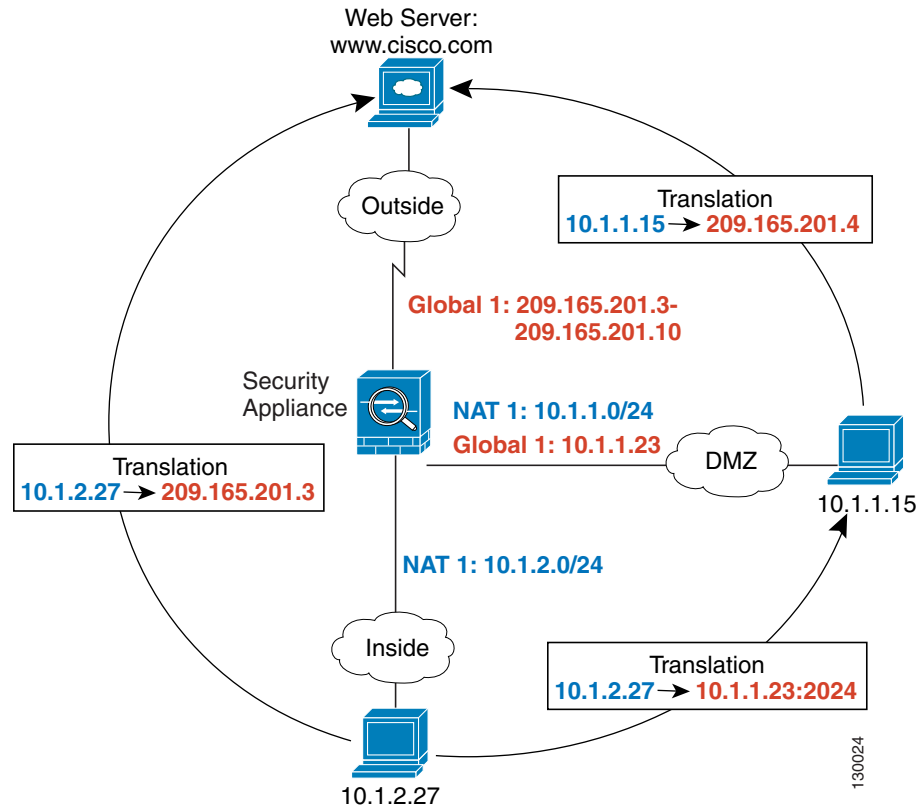

See the following commands for this example:

```
hostname(config)# nat (inside) 1 10.1.2.0 255.255.255.0
hostname(config)# nat (dmz) 1 10.1.1.0 255.255.255.0
hostname(config)# global (outside) 1 209.165.201.3-209.165.201.10
hostname(config)# global (dmz) 1 10.1.1.23
```

If you use different NAT IDs, you can identify different sets of real addresses to have different mapped addresses. For example, on the Inside interface, you can have two **nat** commands on two different NAT IDs. On the Outside interface, you configure two **global** commands for these two IDs. Then, when traffic from Inside network A exits the Outside interface, the IP addresses are translated to pool A addresses; while traffic from Inside network B are translated to pool B addresses (see Figure 14-17). If you use policy NAT, you can specify the same real addresses for multiple **nat** commands, as long as the destination addresses and ports are unique in each access list.

Figure 14-17 Different NAT IDs

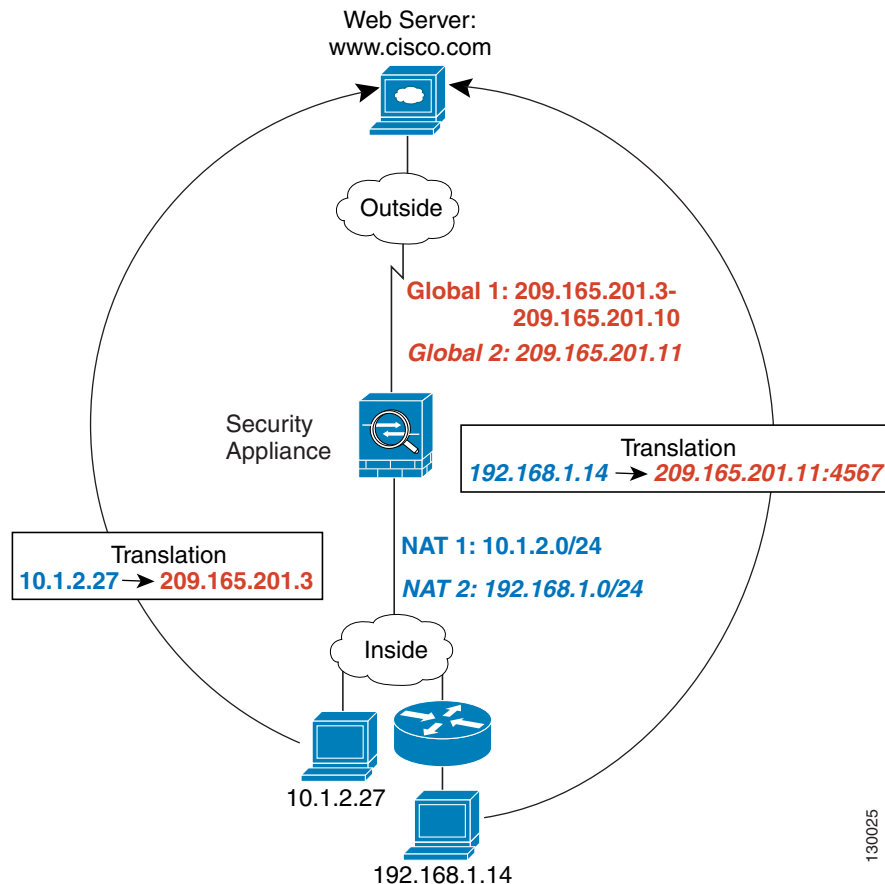

See the following commands for this example:

```
hostname(config)# nat (inside) 1 10.1.2.0 255.255.255.0
hostname(config)# nat (inside) 2 192.168.1.0 255.255.255.0
hostname(config)# global (outside) 1 209.165.201.3-209.165.201.10
hostname(config)# global (outside) 2 209.165.201.11
```

You can enter multiple **global** commands for one interface using the same NAT ID; the security appliance uses the dynamic NAT **global** commands first, in the order they are in the configuration, and then uses the PAT **global** commands in order. You might want to enter both a dynamic NAT **global** command and a PAT **global** command if you need to use dynamic NAT for a particular application, but want to have a backup PAT statement in case all the dynamic NAT addresses are depleted. Similarly, you might enter two PAT statements if you need more than the approximately 64,000 PAT sessions that a single PAT mapped statement supports (see [Figure 14-18](#)).

Figure 14-18 NAT and PAT Together

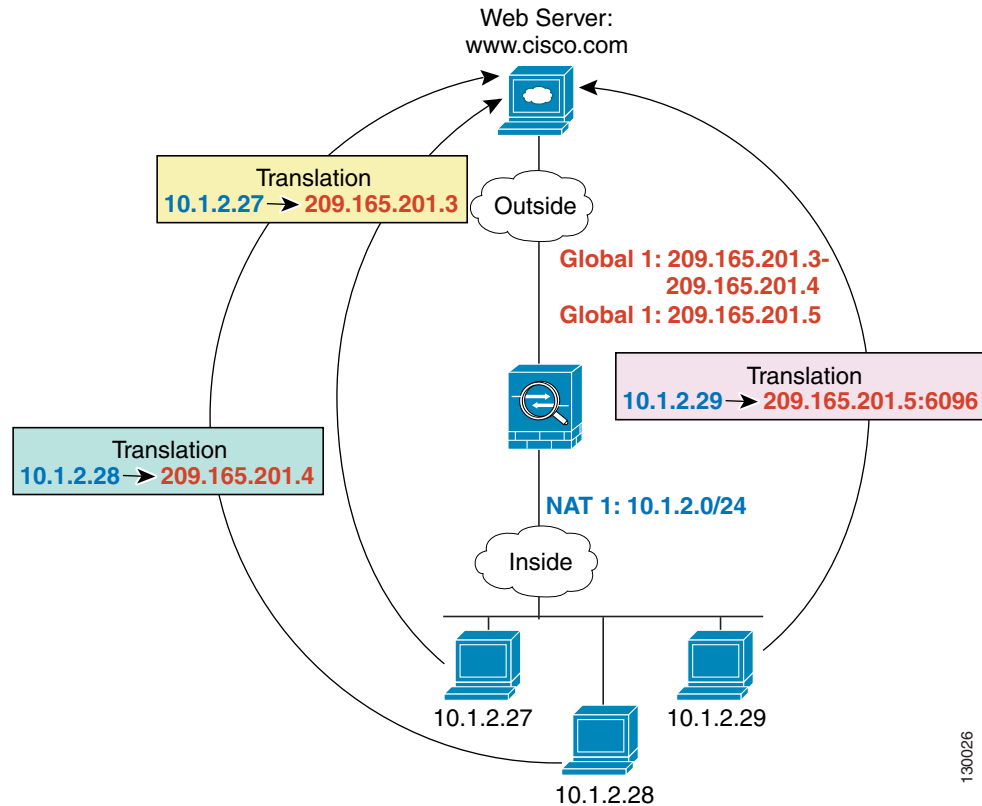

See the following commands for this example:

```
hostname(config)# nat (inside) 1 10.1.2.0 255.255.255.0
hostname(config)# global (outside) 1 209.165.201.3-209.165.201.4
hostname(config)# global (outside) 1 209.165.201.5
```

For outside NAT, you need to identify the **nat** command for outside NAT (the **outside** keyword). If you also want to translate the same traffic when it accesses an inside interface (for example, traffic on a DMZ is translated when accessing the Inside and the Outside interfaces), then you must configure a separate **nat** command without the **outside** option. In this case, you can identify the same addresses in both statements and use the same NAT ID (see Figure 14-19). Note that for outside NAT (DMZ interface to Inside interface), the inside host uses a **static** command to allow outside access, so both the source and destination addresses are translated.

Figure 14-19 Outside NAT and Inside NAT Combined

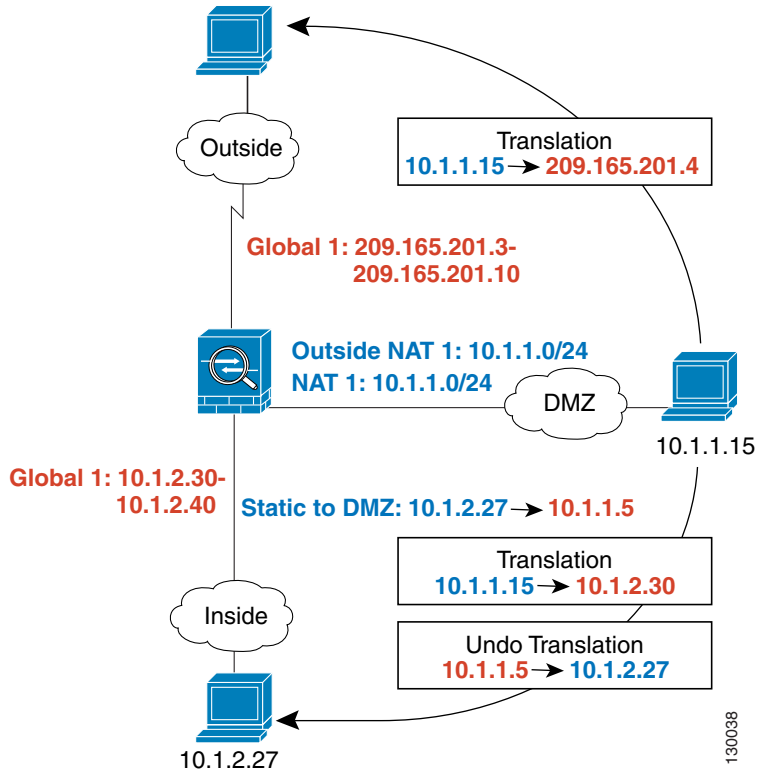

See the following commands for this example:

```
hostname(config)# nat (dmz) 1 10.1.1.0 255.255.255.0 outside
hostname(config)# nat (dmz) 1 10.1.1.0 255.255.255.0
hostname(config)# static (inside,dmz) 10.1.2.27 10.1.1.5 netmask 255.255.255.255
hostname(config)# global (outside) 1 209.165.201.3-209.165.201.4
hostname(config)# global (inside) 1 10.1.2.30-1-10.1.2.40
```

When you specify a group of IP address(es) in a **nat** command, then you must perform NAT on that group of addresses when they access any lower or same security level interface; you must apply a **global** command with the same NAT ID on each interface, or use a **static** command. NAT is not required for that group when it accesses a higher security interface, because to perform NAT from outside to inside, you must create a separate **nat** command using the **outside** keyword. If you do apply outside NAT, then the NAT requirements preceding come into effect for that group of addresses when they access all higher security interfaces. Traffic identified by a **static** command is not affected.

Configuring Dynamic NAT or PAT

This section describes how to configure dynamic NAT or dynamic PAT. The configuration for dynamic NAT and PAT are almost identical; for NAT you specify a range of mapped addresses, and for PAT you specify a single address.

Figure 14-20 shows a typical dynamic NAT scenario. Only translated hosts can create a NAT session, and responding traffic is allowed back. The mapped address is dynamically assigned from a pool defined by the **global** command.

Figure 14-20 Dynamic NAT

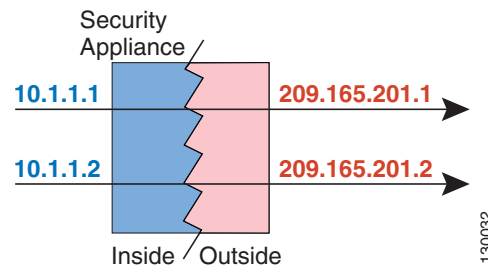
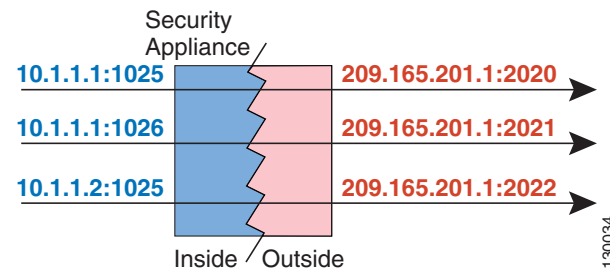

Figure 14-21 shows a typical dynamic PAT scenario. Only translated hosts can create a NAT session, and responding traffic is allowed back. The mapped address defined by the **global** command is the same for each translation, but the port is dynamically assigned.

Figure 14-21 Dynamic PAT



For more information about dynamic NAT, see the “Dynamic NAT” section on page 14-25. For more information about PAT, see the “PAT” section on page 14-26.



Note

If you change the NAT configuration, and you do not want to wait for existing translations to time out before the new NAT information is used, you can clear the translation table using the **clear xlate** command. However, clearing the translation table disconnects all current connections that use translations.

To configure dynamic NAT or PAT, perform the following steps:

Step 1 To identify the real addresses that you want to translate, enter one of the following commands:

- Policy NAT:

```
hostname(config)# nat (real_interface) nat_id access-list acl_name [dns] [outside |
[norandomseq] [[tcp] tcp_max_conns [emb_limit]] [udp udp_max_conns]]
```

You can identify overlapping addresses in other **nat** commands. For example, you can identify 10.1.1.0 in one command, but 10.1.1.1 in another. The traffic is matched to a policy NAT command in order, until the first match, or for regular NAT, using the best match.

See the following description about options for this command:

- **access-list** *acl_name*—Identify the real addresses and destination addresses using an extended access list. Create the access list using the **access-list** command (see the “[Adding an Extended Access List](#)” section on page 13-5). This access list should include only **permit** ACEs. You can optionally specify the real and destination ports in the access list using the **eq** operator. Policy NAT considers the **inactive** and **time-range** keywords, but it does not support ACL with all **inactive** and **time-range** ACEs.
 - *nat_id*—An integer between 1 and 65535. The NAT ID should match a **global** command NAT ID. See the “[Dynamic NAT and PAT Implementation](#)” section on page 14-37 for more information about how NAT IDs are used. **0** is reserved for NAT exemption. (See the “[Configuring NAT Exemption](#)” section on page 14-52 for more information about NAT exemption.)
 - **dns**—If your **nat** command includes the address of a host that has an entry in a DNS server, and the DNS server is on a different interface from a client, then the client and the DNS server need different addresses for the host; one needs the mapped address and one needs the real address. This option rewrites the address in the DNS reply to the client. The translated host needs to be on the same interface as either the client or the DNS server. Typically, hosts that need to allow access from other interfaces use a static translation, so this option is more likely to be used with the **static** command. (See the “[DNS and NAT](#)” section on page 14-34 for more information.)
 - **outside**—If this interface is on a lower security level than the interface you identify by the matching **global** statement, then you must enter **outside** to identify the NAT instance as outside NAT.
 - **norandomseq**, **tcp** *tcp_max_conns*, **udp** *udp_max_conns*, and *emb_limit*—These keywords set connection limits. However, we recommend using a more versatile method for setting connection limits; see the “[Configuring Connection Limits and Timeouts](#)” section on page 19-9.
- Regular NAT:

```
hostname(config)# nat (real_interface) nat_id real_ip [mask [dns] [outside |
[norandomseq] [[tcp] tcp_max_conns [emb_limit]] [udp udp_max_conns]]
```

The *nat_id* is an integer between 1 and 2147483647. The NAT ID must match a **global** command NAT ID. See the “[Dynamic NAT and PAT Implementation](#)” section on page 14-37 for more information about how NAT IDs are used. **0** is reserved for identity NAT. See the “[Configuring Identity NAT](#)” section on page 14-49 for more information about identity NAT.

See the preceding policy NAT command for information about other options.

- Step 2** To identify the mapped address(es) to which you want to translate the real addresses when they exit a particular interface, enter the following command:

```
hostname(config)# global (mapped_interface) nat_id {mapped_ip[-mapped_ip] | interface}
```

This NAT ID should match a **nat** command NAT ID. The matching **nat** command identifies the addresses that you want to translate when they exit this interface.

You can specify a single address (for PAT) or a range of addresses (for NAT). The range can go across subnet boundaries if desired. For example, you can specify the following “supernet”:

```
192.168.1.1-192.168.2.254
```

For example, to translate the 10.1.1.0/24 network on the inside interface, enter the following command:

```
hostname(config)# nat (inside) 1 10.1.1.0 255.255.255.0
hostname(config)# global (outside) 1 209.165.201.1-209.165.201.30
```

To identify a pool of addresses for dynamic NAT as well as a PAT address for when the NAT pool is exhausted, enter the following commands:

```
hostname(config)# nat (inside) 1 10.1.1.0 255.255.255.0
hostname(config)# global (outside) 1 209.165.201.5
hostname(config)# global (outside) 1 209.165.201.10-209.165.201.20
```

To translate the lower security dmz network addresses so they appear to be on the same network as the inside network (10.1.1.0), for example, to simplify routing, enter the following commands:

```
hostname(config)# nat (dmz) 1 10.1.2.0 255.255.255.0 outside dns
hostname(config)# global (inside) 1 10.1.1.45
```

To identify a single real address with two different destination addresses using policy NAT, enter the following commands (see [Figure 14-8 on page 14-30](#) for a related figure):

```
hostname(config)# access-list NET1 permit ip 10.1.2.0 255.255.255.0 209.165.201.0
255.255.255.224
hostname(config)# access-list NET2 permit ip 10.1.2.0 255.255.255.0 209.165.200.224
255.255.255.224
hostname(config)# nat (inside) 1 access-list NET1 tcp 0 2000 udp 10000
hostname(config)# global (outside) 1 209.165.202.129
hostname(config)# nat (inside) 2 access-list NET2 tcp 1000 500 udp 2000
hostname(config)# global (outside) 2 209.165.202.130
```

To identify a single real address/destination address pair that use different ports using policy NAT, enter the following commands (see [Figure 14-9 on page 14-31](#) for a related figure):

```
hostname(config)# access-list WEB permit tcp 10.1.2.0 255.255.255.0 209.165.201.11
255.255.255.255 eq 80
hostname(config)# access-list TELNET permit tcp 10.1.2.0 255.255.255.0 209.165.201.11
255.255.255.255 eq 23
hostname(config)# nat (inside) 1 access-list WEB
hostname(config)# global (outside) 1 209.165.202.129
hostname(config)# nat (inside) 2 access-list TELNET
hostname(config)# global (outside) 2 209.165.202.130
```

Using Static NAT

This section describes how to configure a static translation.

Figure 14-22 shows a typical static NAT scenario. The translation is always active so both translated and remote hosts can originate connections, and the mapped address is statically assigned by the **static** command.

Figure 14-22 Static NAT

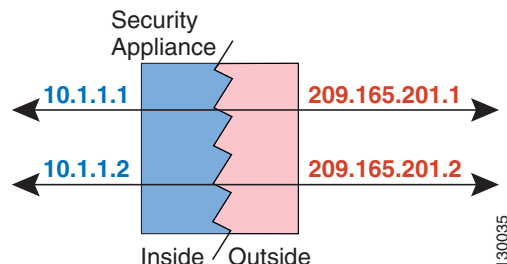

You cannot use the same real or mapped address in multiple **static** commands between the same two interfaces. Do not use a mapped address in the **static** command that is also defined in a **global** command for the same mapped interface.

For more information about static NAT, see the “Static NAT” section on page 14-27.



Note

If you remove a **static** command, existing connections that use the translation are not affected. To remove these connections, enter the **clear local-host** command.

You cannot clear static translations from the translation table with the **clear xlate** command; you must remove the **static** command instead. Only dynamic translations created by the **nat** and **global** commands can be removed with the **clear xlate** command.

To configure static NAT, enter one of the following commands.

- For policy static NAT, enter the following command:

```
hostname(config)# static (real_interface,mapped_interface) {mapped_ip | interface}
access-list acl_name [dns] [norandomseq] [[tcp] tcp_max_conns [emb_limit]] [udp
udp_max_conns]
```

Create the access list using the **access-list** command (see the “Adding an Extended Access List” section on page 13-5). This access list should include only **permit** ACEs. The source subnet mask used in the access list is also used for the mapped addresses. You can also specify the real and destination ports in the access list using the **eq** operator. Policy NAT does not consider the **inactive** or **time-range** keywords; all ACEs are considered to be active for policy NAT configuration. See the “Policy NAT” section on page 14-29 for more information.

If you specify a network for translation (for example, 10.1.1.0 255.255.255.0), then the security appliance translates the .0 and .255 addresses. If you want to prevent access to these addresses, be sure to configure an access list to deny access.

See the “Configuring Dynamic NAT or PAT” section on page 14-43 for information about the other options.

- To configure regular static NAT, enter the following command:

```
hostname(config)# static (real_interface,mapped_interface) {mapped_ip | interface}
real_ip [netmask mask] [dns] [norandomseq] [[tcp] tcp_max_conns [emb_limit]]
[udp udp_max_conns]
```

See the “Configuring Dynamic NAT or PAT” section on page 14-43 for information about the options.

For example, the following policy static NAT example shows a single real address that is translated to two mapped addresses depending on the destination address (see Figure 14-8 on page 14-30 for a related figure):

```
hostname(config)# access-list NET1 permit ip host 10.1.2.27 209.165.201.0 255.255.255.224
hostname(config)# access-list NET2 permit ip host 10.1.2.27 209.165.200.224
255.255.255.224
hostname(config)# static (inside,outside) 209.165.202.129 access-list NET1
hostname(config)# static (inside,outside) 209.165.202.130 access-list NET2
```

The following command maps an inside IP address (10.1.1.3) to an outside IP address (209.165.201.12):

```
hostname(config)# static (inside,outside) 209.165.201.12 10.1.1.3 netmask 255.255.255.255
```

The following command maps the outside address (209.165.201.15) to an inside address (10.1.1.6):

```
hostname(config)# static (outside,inside) 10.1.1.6 209.165.201.15 netmask 255.255.255.255
```

The following command statically maps an entire subnet:

```
hostname(config)# static (inside,dmz) 10.1.1.0 10.1.2.0 netmask 255.255.255.0
```

Using Static PAT

This section describes how to configure a static port translation. Static PAT lets you translate the real IP address to a mapped IP address, as well as the real port to a mapped port. You can choose to translate the real port to the same port, which lets you translate only specific types of traffic, or you can take it further by translating to a different port.

Figure 14-23 shows a typical static PAT scenario. The translation is always active so both translated and remote hosts can originate connections, and the mapped address and port is statically assigned by the **static** command.

Figure 14-23 Static PAT

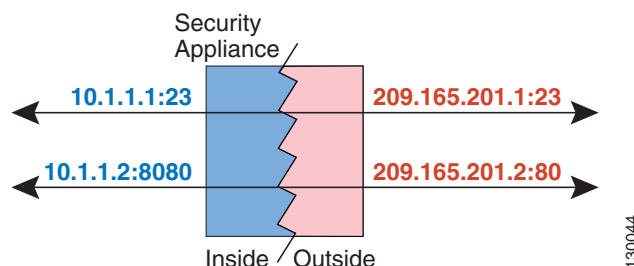

For applications that require application inspection for secondary channels (FTP, VoIP, etc.), the security appliance automatically translates the secondary ports.

You cannot use the same real or mapped address in multiple **static** statements between the same two interfaces. Do not use a mapped address in the **static** command that is also defined in a **global** command for the same mapped interface.

For more information about static PAT, see the [“Static PAT” section on page 14-27](#).

Note

If you remove a **static** command, existing connections that use the translation are not affected. To remove these connections, enter the **clear local-host** command.

You cannot clear static translations from the translation table with the **clear xlate** command; you must remove the **static** command instead. Only dynamic translations created by the **nat** and **global** commands can be removed with the **clear xlate** command.

To configure static PAT, enter one of the following commands.

- For policy static PAT, enter the following command:

```
hostname(config)# static (real_interface,mapped_interface) {tcp | udp} {mapped_ip |
interface} mapped_port access-list acl_name [dns] [norandomseq] [[tcp] tcp_max_conns
[emb_limit]] [udp udp_max_conns]
```

Create the access list using the **access-list** command (see the [“Adding an Extended Access List” section on page 13-5](#)). The protocol in the access list must match the protocol you set in this command. For example, if you specify **tcp** in the **static** command, then you must specify **tcp** in the access list. Specify the port using the **eq** operator. This access list should include only **permit** ACEs. The source subnet mask used in the access list is also used for the mapped addresses. Policy NAT does not consider the **inactive** or **time-range** keywords; all ACEs are considered to be active for policy NAT configuration.

If you specify a network for translation (for example, 10.1.1.0 255.255.255.0), then the security appliance translates the .0 and .255 addresses. If you want to prevent access to these addresses, be sure to configure an access list to deny access.

See the [“Configuring Dynamic NAT or PAT” section on page 14-43](#) for information about the other options.

- To configure regular static PAT, enter the following command:

```
hostname(config)# static (real_interface,mapped_interface) {tcp | udp} {mapped_ip |
interface} mapped_port real_ip real_port [netmask mask] [dns] [norandomseq] [[tcp]
tcp_max_conns [emb_limit]] [udp udp_max_conns]
```

See the [“Configuring Dynamic NAT or PAT” section on page 14-43](#) for information about the options.

For example, for Telnet traffic initiated from hosts on the 10.1.3.0 network to the security appliance outside interface (10.1.2.14), you can redirect the traffic to the inside host at 10.1.1.15 by entering the following commands:

```
hostname(config)# access-list TELNET permit tcp host 10.1.1.15 eq telnet 10.1.3.0
255.255.255.0 eq telnet
hostname(config)# static (inside,outside) tcp 10.1.2.14 telnet access-list TELNET
```

For HTTP traffic initiated from hosts on the 10.1.3.0 network to the security appliance outside interface (10.1.2.14), you can redirect the traffic to the inside host at 10.1.1.15 by entering:

```
hostname(config)# access-list HTTP permit tcp host 10.1.1.15 eq http 10.1.3.0
255.255.255.0 eq http
hostname(config)# static (inside,outside) tcp 10.1.2.14 http access-list HTTP
```

To redirect Telnet traffic from the security appliance outside interface (10.1.2.14) to the inside host at 10.1.1.15, enter the following command:

```
hostname(config)# static (inside,outside) tcp 10.1.2.14 telnet 10.1.1.15 telnet netmask 255.255.255.255
```

If you want to allow the preceding real Telnet server to initiate connections, though, then you need to provide additional translation. For example, to translate all other types of traffic, enter the following commands. The original **static** command provides translation for Telnet to the server, while the **nat** and **global** commands provide PAT for outbound connections from the server.

```
hostname(config)# static (inside,outside) tcp 10.1.2.14 telnet 10.1.1.15 telnet netmask 255.255.255.255
hostname(config)# nat (inside) 1 10.1.1.15 255.255.255.255
hostname(config)# global (outside) 1 10.1.2.14
```

If you also have a separate translation for all inside traffic, and the inside hosts use a different mapped address from the Telnet server, you can still configure traffic initiated from the Telnet server to use the same mapped address as the **static** statement that allows Telnet traffic to the server. You need to create a more exclusive **nat** statement just for the Telnet server. Because **nat** statements are read for the best match, more exclusive **nat** statements are matched before general statements. The following example shows the Telnet **static** statement, the more exclusive **nat** statement for initiated traffic from the Telnet server, and the statement for other inside hosts, which uses a different mapped address.

```
hostname(config)# static (inside,outside) tcp 10.1.2.14 telnet 10.1.1.15 telnet netmask 255.255.255.255
hostname(config)# nat (inside) 1 10.1.1.15 255.255.255.255
hostname(config)# global (outside) 1 10.1.2.14
hostname(config)# nat (inside) 2 10.1.1.0 255.255.255.0
hostname(config)# global (outside) 2 10.1.2.78
```

To translate a well-known port (80) to another port (8080), enter the following command:

```
hostname(config)# static (inside,outside) tcp 10.1.2.45 80 10.1.1.16 8080 netmask 255.255.255.255
```

Bypassing NAT

This section describes how to bypass NAT. You might want to bypass NAT when you enable NAT control. You can bypass NAT using identity NAT, static identity NAT, or NAT exemption. See the [“Bypassing NAT when NAT Control is Enabled” section on page 14-28](#) for more information about these methods. This section includes the following topics:

- [Configuring Identity NAT, page 14-49](#)
- [Configuring Static Identity NAT, page 14-50](#)
- [Configuring NAT Exemption, page 14-52](#)

Configuring Identity NAT

Identity NAT translates the real IP address to the same IP address. Only “translated” hosts can create NAT translations, and responding traffic is allowed back.

Figure 14-24 shows a typical identity NAT scenario.

Figure 14-24 Identity NAT

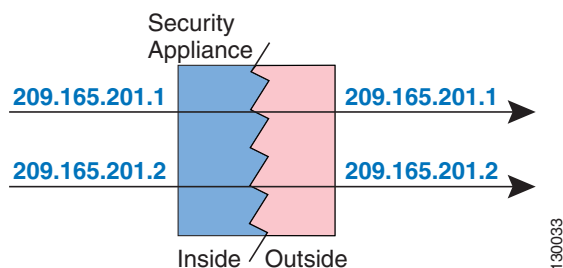

Note

If you change the NAT configuration, and you do not want to wait for existing translations to time out before the new NAT information is used, you can clear the translation table using the **clear xlate** command. However, clearing the translation table disconnects all current connections that use translations.

To configure identity NAT, enter the following command:

```
hostname(config)# nat (real_interface) 0 real_ip [mask [dns] [outside | [norandomseq]
[[tcp] tcp_max_conns [emb_limit]] [udp udp_max_conns]]]
```

See the “Configuring Dynamic NAT or PAT” section on page 14-43 for information about the options.

For example, to use identity NAT for the inside 10.1.1.0/24 network, enter the following command:

```
hostname(config)# nat (inside) 0 10.1.1.0 255.255.255.0
```

Configuring Static Identity NAT

Static identity NAT translates the real IP address to the same IP address. The translation is always active, and both “translated” and remote hosts can originate connections. Static identity NAT lets you use regular NAT or policy NAT. Policy NAT lets you identify the real and destination addresses when determining the real addresses to translate (see the “Policy NAT” section on page 14-29 for more information about policy NAT). For example, you can use policy static identity NAT for an inside address when it accesses the outside interface and the destination is server A, but use a normal translation when accessing the outside server B.

Figure 14-25 shows a typical static identity NAT scenario.

Figure 14-25 Static Identity NAT

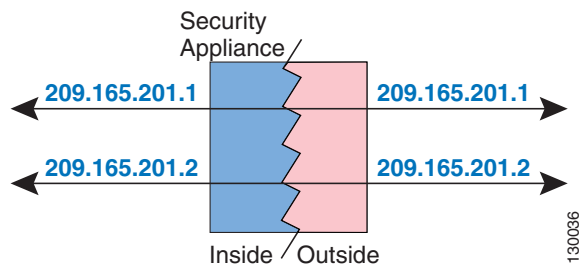

**Note**

If you remove a **static** command, existing connections that use the translation are not affected. To remove these connections, enter the **clear local-host** command.

You cannot clear static translations from the translation table with the **clear xlate** command; you must remove the **static** command instead. Only dynamic translations created by the **nat** and **global** commands can be removed with the **clear xlate** command.

To configure static identity NAT, enter one of the following commands:

- To configure policy static identity NAT, enter the following command:

```
hostname(config)# static (real_interface,mapped_interface) real_ip access-list acl_id
[dns] [norandomseq] [[tcp] tcp_max_conns [emb_limit]] [udp udp_max_conns]
```

Create the access list using the **access-list** command (see the [“Adding an Extended Access List” section on page 13-5](#)). This access list should include only **permit** ACEs. Make sure the source address in the access list matches the *real_ip* in this command. Policy NAT does not consider the **inactive** or **time-range** keywords; all ACEs are considered to be active for policy NAT configuration. See the [“Policy NAT” section on page 14-29](#) for more information.

See the [“Configuring Dynamic NAT or PAT” section on page 14-43](#) for information about the other options.

- To configure regular static identity NAT, enter the following command:

```
hostname(config)# static (real_interface,mapped_interface) real_ip real_ip [netmask
mask] [dns] [norandomseq] [[tcp] tcp_max_conns [emb_limit]] [udp udp_max_conns]
```

Specify the same IP address for both *real_ip* arguments.

See the [“Configuring Dynamic NAT or PAT” section on page 14-43](#) for information about the other options.

For example, the following command uses static identity NAT for an inside IP address (10.1.1.3) when accessed by the outside:

```
hostname(config)# static (inside,outside) 10.1.1.3 10.1.1.3 netmask 255.255.255.255
```

The following command uses static identity NAT for an outside address (209.165.201.15) when accessed by the inside:

```
hostname(config)# static (outside,inside) 209.165.201.15 209.165.201.15 netmask
255.255.255.255
```

The following command statically maps an entire subnet:

```
hostname(config)# static (inside,dmz) 10.1.2.0 10.1.2.0 netmask 255.255.255.0
```

The following static identity policy NAT example shows a single real address that uses identity NAT when accessing one destination address, and a translation when accessing another:

```
hostname(config)# access-list NET1 permit ip host 10.1.2.27 209.165.201.0 255.255.255.224
hostname(config)# access-list NET2 permit ip host 10.1.2.27 209.165.200.224
255.255.255.224
hostname(config)# static (inside,outside) 10.1.2.27 access-list NET1
hostname(config)# static (inside,outside) 209.165.202.130 access-list NET2
```

Configuring NAT Exemption

NAT exemption exempts addresses from translation and allows both real and remote hosts to originate connections. NAT exemption lets you specify the real and destination addresses when determining the real traffic to exempt (similar to policy NAT), so you have greater control using NAT exemption than identity NAT. However unlike policy NAT, NAT exemption does not consider the ports in the access list. Use static identity NAT to consider ports in the access list.

Figure 14-26 shows a typical NAT exemption scenario.

Figure 14-26 NAT Exemption

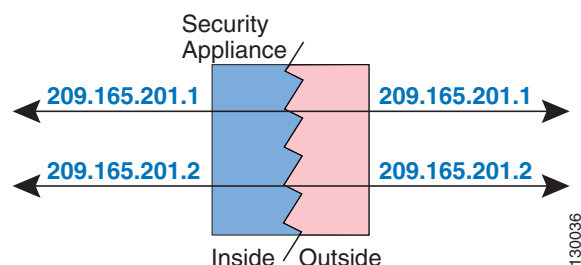

Note

If you remove a NAT exemption configuration, existing connections that use NAT exemption are not affected. To remove these connections, enter the **clear local-host** command.

To configure NAT exemption, enter the following command:

```
hostname(config)# nat (real_interface) 0 access-list acl_name [outside]
```

Create the access list using the **access-list** command (see the “Adding an Extended Access List” section on page 13-5). This access list can include both **permit** ACEs and **deny** ACEs. Do not specify the real and destination ports in the access list; NAT exemption does not consider the ports. NAT exemption considers the **inactive** and **time-range** keywords, but it does not support ACL with all **inactive** and **time-range** ACLs.

By default, this command exempts traffic from inside to outside. If you want traffic from outside to inside to bypass NAT, then add an additional **nat** command and enter **outside** to identify the NAT instance as outside NAT. You might want to use outside NAT exemption if you configure dynamic NAT for the outside interface and want to exempt other traffic.

For example, to exempt an inside network when accessing any destination address, enter the following command:

```
hostname(config)# access-list EXEMPT permit ip 10.1.2.0 255.255.255.0 any
hostname(config)# nat (inside) 0 access-list EXEMPT
```

To use dynamic outside NAT for a DMZ network, and exempt another DMZ network, enter the following command:

```
hostname(config)# nat (dmz) 1 10.1.2.0 255.255.255.0 outside dns
hostname(config)# global (inside) 1 10.1.1.45
hostname(config)# access-list EXEMPT permit ip 10.1.3.0 255.255.255.0 any
hostname(config)# nat (dmz) 0 access-list EXEMPT
```

To exempt an inside address when accessing two different destination addresses, enter the following commands:

```
hostname(config)# access-list NET1 permit ip 10.1.2.0 255.255.255.0 209.165.201.0
255.255.255.224
hostname(config)# access-list NET1 permit ip 10.1.2.0 255.255.255.0 209.165.200.224
255.255.255.224
hostname(config)# nat (inside) 0 access-list NET1
```

NAT Examples

This section describes typical scenarios that use NAT solutions, and includes the following topics:

- [Overlapping Networks, page 14-53](#)
- [Redirecting Ports, page 14-55](#)

Overlapping Networks

In [Figure 14-27](#), the security appliance connects two private networks with overlapping address ranges.

Figure 14-27 Using Outside NAT with Overlapping Networks

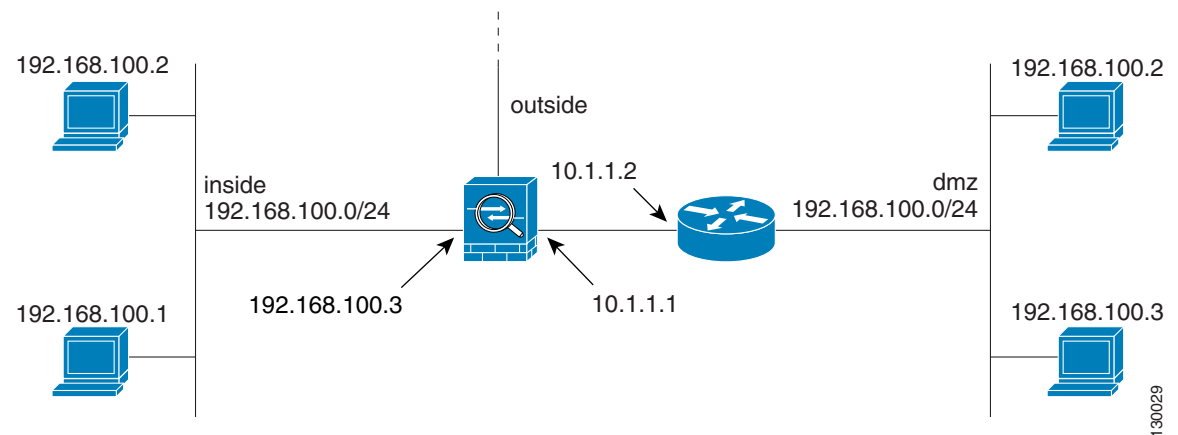

Two networks use an overlapping address space (192.168.100.0/24), but hosts on each network must communicate (as allowed by access lists). Without NAT, when a host on the inside network tries to access a host on the overlapping DMZ network, the packet never makes it past the security appliance, which sees the packet as having a destination address on the inside network. Moreover, if the destination address is being used by another host on the inside network, that host receives the packet.

To solve this problem, use NAT to provide non-overlapping addresses. If you want to allow access in both directions, use static NAT for both networks. If you only want to allow the inside interface to access hosts on the DMZ, then you can use dynamic NAT for the inside addresses, and static NAT for the DMZ addresses you want to access. This example shows static NAT.

To configure static NAT for these two interfaces, perform the following steps. The 10.1.1.0/24 network on the DMZ is not translated.

Step 1 Translate 192.168.100.0/24 on the inside to 10.1.2.0 /24 when it accesses the DMZ by entering the following command:

```
hostname(config)# static (inside,dmz) 10.1.2.0 192.168.100.0 netmask 255.255.255.0
```

Step 2 Translate the 192.168.100.0/24 network on the DMZ to 10.1.3.0/24 when it accesses the inside by entering the following command:

```
hostname(config)# static (dmz,inside) 10.1.3.0 192.168.100.0 netmask 255.255.255.0
```

Step 3 Configure the following static routes so that traffic to the dmz network can be routed correctly by the security appliance:

```
hostname(config)# route dmz 192.168.100.128 255.255.255.128 10.1.1.2 1  
hostname(config)# route dmz 192.168.100.0 255.255.255.128 10.1.1.2 1
```

The security appliance already has a connected route for the inside network. These static routes allow the security appliance to send traffic for the 192.168.100.0/24 network out the DMZ interface to the gateway router at 10.1.1.2. (You need to split the network into two because you cannot create a static route with the exact same network as a connected route.) Alternatively, you could use a more broad route for the DMZ traffic, such as a default route.

If host 192.168.100.2 on the DMZ network wants to initiate a connection to host 192.168.100.2 on the inside network, the following events occur:

1. The DMZ host 192.168.100.2 sends the packet to IP address 10.1.2.2.
2. When the security appliance receives this packet, the security appliance translates the source address from 192.168.100.2 to 10.1.3.2.
3. Then the security appliance translates the destination address from 10.1.2.2 to 192.168.100.2, and the packet is forwarded.

Redirecting Ports

Figure 14-28 illustrates a typical network scenario in which the port redirection feature might be useful.

Figure 14-28 Port Redirection Using Static PAT

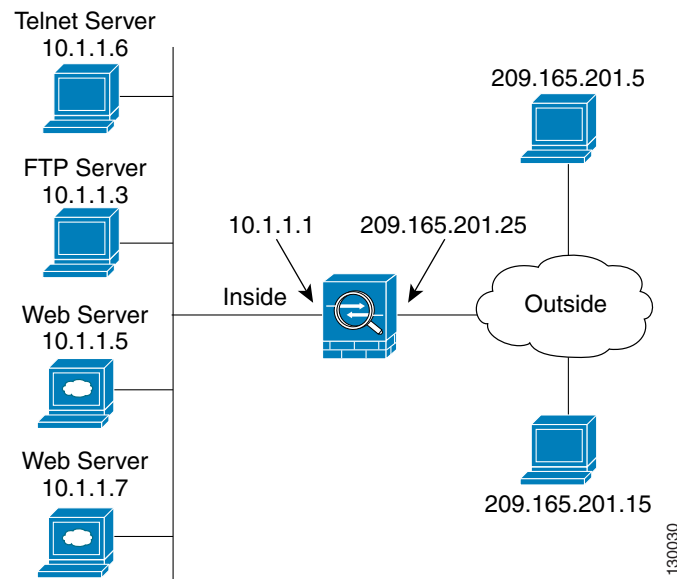

In the configuration described in this section, port redirection occurs for hosts on external networks as follows:

- Telnet requests to IP address 209.165.201.5 are redirected to 10.1.1.6.
- FTP requests to IP address 209.165.201.5 are redirected to 10.1.1.3.
- HTTP request to security appliance outside IP address 209.165.201.25 are redirected to 10.1.1.5.
- HTTP port 8080 requests to PAT address 209.165.201.15 are redirected to 10.1.1.7 port 80.

To implement this scenario, perform the following steps:

Step 1 Configure PAT for the inside network by entering the following commands:

```
hostname(config)# nat (inside) 1 0.0.0.0 0.0.0.0 0 0
hostname(config)# global (outside) 1 209.165.201.15
```

Step 2 Redirect Telnet requests for 209.165.201.5 to 10.1.1.6 by entering the following command:

```
hostname(config)# static (inside,outside) tcp 209.165.201.5 telnet 10.1.1.6 telnet netmask
255.255.255.255
```

Step 3 Redirect FTP requests for IP address 209.165.201.5 to 10.1.1.3 by entering the following command:

```
hostname(config)# static (inside,outside) tcp 209.165.201.5 ftp 10.1.1.3 ftp netmask
255.255.255.255
```

Step 4 Redirect HTTP requests for the security appliance outside interface address to 10.1.1.5 by entering the following command:

```
hostname(config)# static (inside,outside) tcp interface www 10.1.1.5 www netmask
255.255.255.255
```

- Step 5** Redirect HTTP requests on port 8080 for PAT address 209.165.201.15 to 10.1.1.7 port 80 by entering the following command:

```
hostname(config)# static (inside,outside) tcp 209.165.201.15 8080 10.1.1.7 www netmask  
255.255.255.255
```



Permitting or Denying Network Access

This chapter describes how to control network access through the security appliance using access lists. To create an extended access lists or an EtherType access list, see [Chapter 13, “Identifying Traffic with Access Lists.”](#)



Note

You use ACLs to control network access in both routed and transparent firewall modes. In transparent mode, you can use both extended ACLs (for Layer 3 traffic) and EtherType ACLs (for Layer 2 traffic).

This chapter includes the following sections:

- [Inbound and Outbound Access List Overview, page 15-1](#)
- [Applying an Access List to an Interface, page 15-2](#)

Inbound and Outbound Access List Overview

By default, all traffic from a higher-security interface to a lower-security interface is allowed. Access lists let you either allow traffic from lower-security interfaces, or restrict traffic from higher-security interfaces.

The security appliance supports two types of access lists:

- Inbound—Inbound access lists apply to traffic as it enters an interface.
- Outbound—Outbound access lists apply to traffic as it exits an interface.



Note

“Inbound” and “outbound” refer to the application of an access list on an interface, either to traffic entering the security appliance on an interface or traffic exiting the security appliance on an interface. These terms do not refer to the movement of traffic from a lower security interface to a higher security interface, commonly known as inbound, or from a higher to lower interface, commonly known as outbound.

An outbound access list is useful, for example, if you want to allow only certain hosts on the inside networks to access a web server on the outside network. Rather than creating multiple inbound access lists to restrict access, you can create a single outbound access list that allows only the specified hosts

(see Figure 15-1). See the “IP Addresses Used for Access Lists When You Use NAT” section on page 13-3 for information about NAT and IP addresses. The outbound access list prevents any other hosts from reaching the outside network.

Figure 15-1 Outbound Access List

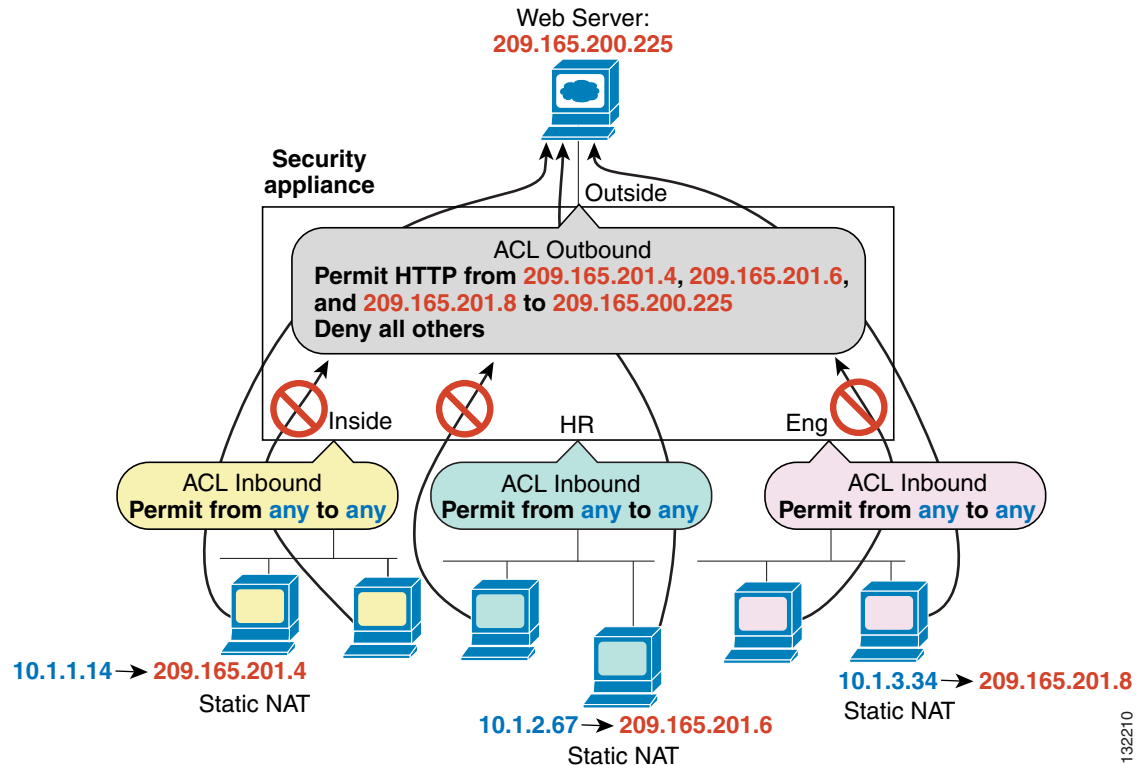

See the following commands for this example:

```
hostname(config)# access-list OUTSIDE extended permit tcp host 209.165.201.4
host 209.165.200.225 eq www
hostname(config)# access-list OUTSIDE extended permit tcp host 209.165.201.6
host 209.165.200.225 eq www
hostname(config)# access-list OUTSIDE extended permit tcp host 209.165.201.8
host 209.165.200.225 eq www
hostname(config)# access-group OUTSIDE out interface outside
```

Applying an Access List to an Interface

To apply an extended access list to the inbound or outbound direction of an interface, enter the following command:

```
hostname(config)# access-group access_list_name {in | out} interface interface_name
[per-user-override]
```

You can apply one access list of each type (extended and EtherType) to both directions of the interface. See the “Inbound and Outbound Access List Overview” section on page 15-1 for more information about access list directions.

The **per-user-override** keyword allows dynamic access lists that are downloaded for user authorization to override the access list assigned to the interface. For example, if the interface access list denies all traffic from 10.0.0.0, but the dynamic access list permits all traffic from 10.0.0.0, then the dynamic access list overrides the interface access list for that user. See the “Configuring RADIUS Authorization” section for more information about per-user access lists. The **per-user-override** keyword is only available for inbound access lists.

For connectionless protocols, you need to apply the access list to the source and destination interfaces if you want traffic to pass in both directions. For example, you can allow BGP in an EtherType access list in transparent mode, and you need to apply the access list to both interfaces.

The following example illustrates the commands required to enable access to an inside web server with the IP address 209.165.201.12 (this IP address is the address visible on the outside interface after NAT):

```
hostname(config)# access-list ACL_OUT extended permit tcp any host 209.165.201.12 eq www
hostname(config)# access-group ACL_OUT in interface outside
```

You also need to configure NAT for the web server.

The following access lists allow *any* hosts to communicate between the **inside** and **hr** networks, but only specific hosts (209.168.200.3 and 209.168.200.4) to access the outside network, as shown in the last line below:

```
hostname(config)# access-list ANY extended permit ip any any
hostname(config)# access-list OUT extended permit ip host 209.168.200.3 any
hostname(config)# access-list OUT extended permit ip host 209.168.200.4 any

hostname(config)# access-group ANY in interface inside
hostname(config)# access-group ANY in interface hr
hostname(config)# access-group OUT out interface outside
```

For example, the following sample access list allows common EtherTypes originating on the inside interface:

```
hostname(config)# access-list ETHER ethertype permit ipx
hostname(config)# access-list ETHER ethertype permit bpdu
hostname(config)# access-list ETHER ethertype permit mpls-unicast
hostname(config)# access-group ETHER in interface inside
```

The following access list allows some EtherTypes through the security appliance, but denies all others:

```
hostname(config)# access-list ETHER ethertype permit 0x1234
hostname(config)# access-list ETHER ethertype permit bpdu
hostname(config)# access-list ETHER ethertype permit mpls-unicast
hostname(config)# access-group ETHER in interface inside
hostname(config)# access-group ETHER in interface outside
```

The following access list denies traffic with EtherType 0x1256 but allows all others on both interfaces:

```
hostname(config)# access-list nonIP ethertype deny 1256
hostname(config)# access-list nonIP ethertype permit any
hostname(config)# access-group ETHER in interface inside
hostname(config)# access-group ETHER in interface outside
```



Applying AAA for Network Access

This chapter describes how to enable AAA (pronounced “triple A”) for network access.

This chapter contains the following sections:

- [AAA Performance, page 16-1](#)
- [Configuring Authentication for Network Access, page 16-1](#)
- [Configuring Authorization for Network Access, page 16-6](#)
- [Configuring Accounting for Network Access, page 16-12](#)
- [Using MAC Addresses to Exempt Traffic from Authentication and Authorization, page 16-13](#)

AAA Performance

The security appliance uses “cut-through proxy” to significantly improve performance compared to a traditional proxy server. The performance of a traditional proxy server suffers because it analyzes every packet at the application layer of the OSI model. The security appliance cut-through proxy challenges a user initially at the application layer and then authenticates against standard RADIUS, TACACS+, or the local database. After the security appliance authenticates the user, it shifts the session flow, and all traffic flows directly and quickly between the source and destination while maintaining session state information.

Configuring Authentication for Network Access

This section includes the following topics:

- [Authentication Overview, page 16-2](#)
- [Enabling Network Access Authentication, page 16-3](#)
- [Enabling Secure Authentication of Web Clients, page 16-4](#)

Authentication Overview

The security appliance lets you configure network access authentication using AAA servers.

A user at a given IP address only needs to authenticate one time for all rules and types, until the authentication session expires. (See the **timeout uauth** command in the *Cisco Security Appliance Command Reference* for timeout values.) For example, if you configure the security appliance to authenticate Telnet and FTP and a user first successfully authenticates for Telnet, then as long as the authentication session exists, the user does not also have to authenticate for FTP.

Although you can configure the security appliance to require authentication for network access to any protocol or service, users can authenticate directly with HTTP(S), Telnet, or FTP only. A user must first authenticate with one of these services before the security appliance allows other traffic requiring authentication.

If you do not want to allow HTTP(S), Telnet, or FTP through the security appliance but want to authenticate other types of traffic, you can configure virtual Telnet. With virtual Telnet, the user Telnets to a given IP address configured on the security appliance and the security appliance provides a Telnet prompt. For more information about the **virtual telnet** command, see the *Cisco Security Appliance Command Reference*.

For Telnet, HTTP(S), and FTP, the security appliance generates an authentication prompt. If the destination server also has its own authentication, the user enters another username and password.

For HTTP authentication, the security appliance checks local ports when static NAT is configured. If it detects traffic destined for local port 80, regardless of the global port, the security appliance intercepts the HTTP connection and enforces authentication.

For example, assume that outside TCP port 889 is translated to port 80 (www) and that any relevant ACLs permit the traffic:

```
static (inside,outside) tcp 10.48.66.155 889 192.168.123.10 www netmask 255.255.255.255
```

then when users try to access 10.48.66.155 on port 889, the security appliance intercepts the traffic and enforces HTTP authentication. Users see the HTTP authentication page in their web browsers before the security appliance allows HTTP connection to complete.

If the local port is different than port 80, as in the following example:

```
static (inside,outside) tcp 10.48.66.155 889 192.168.123.10 111 netmask 255.255.255.255
```

then users do not see the authentication page. Instead, the security appliance sends to the web browser an error message indicating that the user must be authenticated prior using the requested service.



Note

If you use HTTP authentication without using the **aaa authentication secure-http-client** command, the username and password are sent in clear text to the destination web server, and not just to the AAA server. For example, if you authenticate inside users when they access outside web servers, anyone on the outside can learn valid usernames and passwords. We recommend that you use the **aaa authentication secure-http-client** command whenever you enable HTTP authentication. For more information about the **aaa authentication secure-http-client** command, see the [“Enabling Secure Authentication of Web Clients”](#) section on page 16-4.

For FTP, a user has the option of entering the security appliance username followed by an at sign (@) and then the FTP username (name1@name2). For the password, the user enters the security appliance password followed by an at sign (@) and then the FTP password (password1@password2). For example, enter the following text.

```
name> jamiec@jchrichton
```



```
password> letmein@he110
```

This feature is useful when you have cascaded firewalls that require multiple logins. You can separate several names and passwords by multiple at signs (@).

Enabling Network Access Authentication

To enable network access authentication, perform the following steps:

Step 1 Using the **aaa-server** command, identify your AAA servers. If you have already identified your AAA servers, continue to the next step.

For more information about identifying AAA servers, see the [“Identifying AAA Server Groups and Servers”](#) section on page 10-11.

Step 2 Using the **access-list** command, create an ACL that identifies the source addresses and destination addresses of traffic you want to authenticate. For steps, see the [“Adding an Extended Access List”](#) section on page 13-5.

The **permit** ACEs mark matching traffic for authentication, while **deny** entries exclude matching traffic from authentication. Be sure to include the destination ports for either HTTP, Telnet, or FTP in the ACL because the user must authenticate with one of these services before other services are allowed through the security appliance.

Step 3 To configure authentication, enter the following command:

```
hostname/contexta(config)# aaa authentication match acl_name interface_name server_group
```

where *acl_name* is the name of the ACL you created in [Step 2](#), *interface_name* is the name of the interface as specified with the **nameif** command, and *server_group* is the AAA server group you created in [Step 1](#).



Note

You can alternatively use the **aaa authentication include** command (which identifies traffic within the command). However, you cannot use both methods in the same configuration. See the *Cisco Security Appliance Command Reference* for more information.

Step 4 (Optional) If you are using the local database for network access authentication and you want to limit the number of consecutive failed login attempts that the security appliance allows any given user account, use the **aaa local authentication attempts max-fail** command. For example:

```
hostname/contexta(config)# aaa local authentication attempts max-fail 7
```



Tip

To clear the lockout status of a specific user or all users, use the **clear aaa local user lockout** command.

For example, the following commands authenticate all inside HTTP traffic and SMTP traffic:

```
hostname/contexta(config)# aaa-server AuthOutbound protocol tacacs+
hostname/contexta(config-aaa-server-group)# exit
hostname/contexta(config)# aaa-server AuthOutbound (inside) host 10.1.1.1
hostname/contexta(config-aaa-server-host)# key TACPlusUauthKey
hostname/contexta(config-aaa-server-host)# exit
hostname/contexta(config)# access-list MAIL_AUTH extended permit tcp any any eq smtp
hostname/contexta(config)# access-list MAIL_AUTH extended permit tcp any any eq www
```

```
hostname/contexta(config)# aaa authentication match MAIL_AUTH inside AuthOutbound
```

The following commands authenticate Telnet traffic from the outside interface to a particular server (209.165.201.5):

```
hostname/contexta(config)# aaa-server AuthInbound protocol tacacs+
hostname/contexta(config-aaa-server-group)# exit
hostname/contexta(config)# aaa-server AuthInbound (inside) host 10.1.1.1
hostname/contexta(config-aaa-server-host)# key TACPlusUauthKey
hostname/contexta(config-aaa-server-host)# exit
hostname/contexta(config)# access-list TELNET_AUTH extended permit tcp any host
209.165.201.5 eq telnet
hostname/contexta(config)# aaa authentication match TELNET_AUTH outside AuthInbound
```

Enabling Secure Authentication of Web Clients

The security appliance provides a method of securing HTTP authentication. Without securing HTTP authentication, usernames and passwords provided to the security appliance would be passed to the destination web server. By using the **aaa authentication secure-http-client** command, you enable the exchange of usernames and passwords between a web client and the security appliance with HTTPS. HTTPS encrypts the transmission, preventing the username and password from being passed to the external web server by HTTP.

After enabling this feature, when a user accesses a web page requiring authentication, the security appliance displays the Authentication Proxy Login Page shown in [Figure 16-1](#).

Figure 16-1 Authentication Proxy Login Page

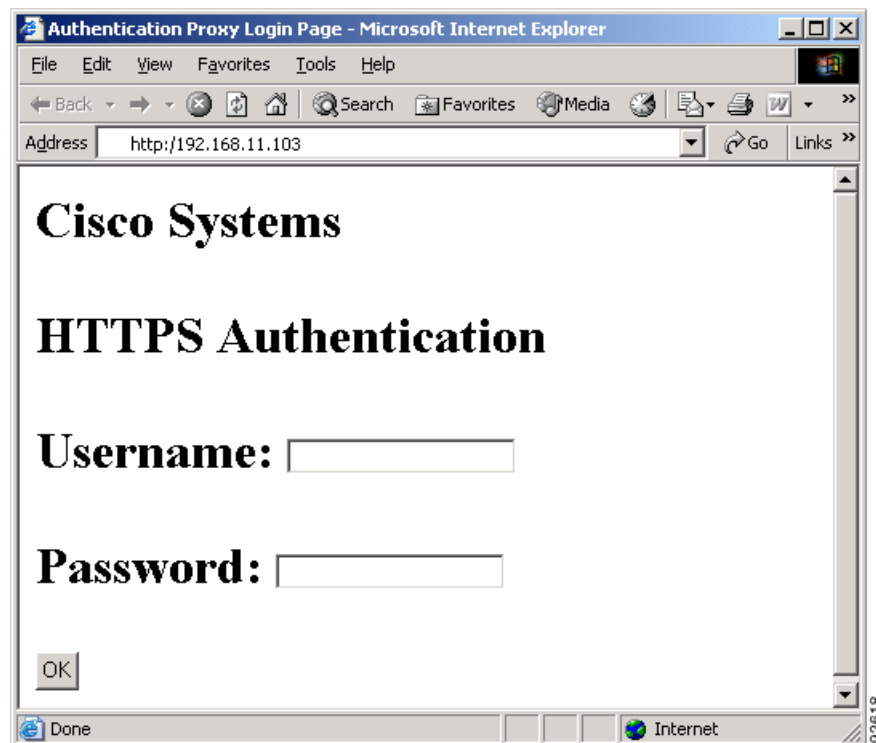

**Note**

The Cisco Systems text field shown in this example was customized using the **auth-prompt** command. For the detailed syntax of this command refer to the *Cisco Security Appliance Command Reference*. If you do not enter a string using the **auth-prompt** command, this field will be blank.

After the user enters a valid username and password, an “Authentication Successful” page appears and closes automatically. If the user fails to enter a valid username and password, an “Authentication Failed” page appears.

Secured web-client authentication has the following limitations:

- A maximum of 16 concurrent HTTPS authentication sessions are allowed. If all 16 HTTPS authentication processes are running, a new connection requiring authentication will not succeed.
- When **uauth timeout 0** is configured (the **uauth timeout** is set to 0), HTTPS authentication might not work. If a browser initiates multiple TCP connections to load a web page after HTTPS authentication, the first connection is let through, but the subsequent connections trigger authentication. As a result, users are continuously presented with an authentication page, even if the correct username and password are entered each time. To work around this, set the **uauth timeout** to 1 second with the **timeout uauth 0:0:1** command. However, this workaround opens a 1-second window of opportunity that might allow non-authenticated users to go through the firewall if they are coming from the same source IP address.
- Because HTTPS authentication occurs on the SSL port 443, users must not configure an **access-list** command statement to block traffic from the HTTP client to HTTP server on port 443. Furthermore, if static PAT is configured for web traffic on port 80, it must also be configured for the SSL port. In the following example, the first line configures static PAT for web traffic and the second line must be added to support the HTTPS authentication configuration.

```
static (inside,outside) tcp 10.132.16.200 www 10.130.16.10 www
static (inside,outside) tcp 10.132.16.200 443 10.130.16.10 443
```
- HTTP users see a pop-up window generated by the browser itself if **aaa authentication secure-http-client** is not configured. If **aaa authentication secure-http-client** is configured, a form loads in the browser to collect username and password. In either case, if a user enters an incorrect password, the user is prompted again. When the web server and the authentication server are on different hosts, use the **virtual** command to get the correct authentication behavior.

To enable secure authentication of web clients, perform the following steps:

Step 1 Enable HTTP authentication. For more information about enabling authentication, see the [“Enabling Network Access Authentication”](#) section on page 16-3.

Step 2 To enable secure authentication of web clients, enter this command:

```
aaa authentication secure-http-client
```

**Note**

Use of the **aaa authentication secure-http-client** command is not dependent upon enabling HTTP authentication. If you prefer, you can enter this command before you enable HTTP authentication so that if you later enable HTTP authentication, usernames and passwords are already protected by secured web-client authentication.

Configuring Authorization for Network Access

After a user authenticates for a given connection, the security appliance can use authorization to further control traffic from the user.

This section includes the following topics:

- [Configuring TACACS+ Authorization, page 16-6](#)
- [Configuring RADIUS Authorization, page 16-7](#)

Configuring TACACS+ Authorization

You can configure the security appliance to perform network access authorization with TACACS+. You identify the traffic to be authorized by specifying ACLs that authorization rules must match. Alternatively, you can identify the traffic directly in authorization rules themselves.



Tip

Using ACLs to identify traffic to be authorized can greatly reduced the number of authorization commands you must enter. This is because each authorization rule you enter can specify only one source and destination subnet and service, whereas an ACL can include many entries.

Authentication and authorization statements are independent; however, any unauthenticated traffic matched by an authorization statement will be denied. For authorization to succeed, a user must first authenticate with the security appliance. Because a user at a given IP address only needs to authenticate one time for all rules and types, if the authentication session hasn't expired, authorization can occur even if the traffic is matched by an authentication statement.

After a user authenticates, the security appliance checks the authorization rules for matching traffic. If the traffic matches the authorization statement, the security appliance sends the username to the TACACS+ server. The TACACS+ server responds to the security appliance with a permit or a deny for that traffic, based on the user profile. The security appliance enforces the authorization rule in the response.

See the documentation for your TACACS+ server for information about configuring network access authorizations for a user.

To configure TACACS+ authorization, perform the following steps:

-
- Step 1** Enable authentication. For more information, see the [“Enabling Network Access Authentication” section on page 16-3](#). If you have already enabled authentication, continue to the next step.
- Step 2** Using the **access-list** command, create an ACL that identifies the source addresses and destination addresses of traffic you want to authorize. For steps, see the [“Adding an Extended Access List” section on page 13-5](#).

The **permit** ACEs mark matching traffic for authorization, while **deny** entries exclude matching traffic from authorization. The ACL you use for authorization matching should contain rules that are equal to or a subset of the rules in the ACL used for authentication matching.



Note

If you have configured authentication and want to authorize all the traffic being authenticated, you can use the same ACL you created for use with the **aaa authentication match** command.

Step 3 To enable authorization, enter the following command:

```
hostname/contexta(config)# aaa authorization match acl_name interface_name server_group
```

where *acl_name* is the name of the ACL you created in [Step 2](#), *interface_name* is the name of the interface as specified with the **nameif** command or by default, and *server_group* is the AAA server group you created when you enabled authentication.



Note Alternatively, you can use the **aaa authorization include** command (which identifies traffic within the command) but you cannot use both methods in the same configuration. See the *Cisco Security Appliance Command Reference* for more information.

The following commands authenticate and authorize inside Telnet traffic. Telnet traffic to servers other than 209.165.201.5 can be authenticated alone, but traffic to 209.165.201.5 requires authorization.

```
hostname/contexta(config)# access-list TELNET_AUTH extended permit tcp any any eq telnet
hostname/contexta(config)# access-list SERVER_AUTH extended permit tcp any host
209.165.201.5 eq telnet
hostname/contexta(config)# aaa-server AuthOutbound protocol tacacs+
hostname/contexta(config-aaa-server-group)# exit
hostname/contexta(config)# aaa-server AuthOutbound (inside) host 10.1.1.1
hostname/contexta(config-aaa-server-host)# key TACPlusUauthKey
hostname/contexta(config-aaa-server-host)# exit
hostname/contexta(config)# aaa authentication match TELNET_AUTH inside AuthOutbound
hostname/contexta(config)# aaa authorization match SERVER_AUTH inside AuthOutbound
```

Configuring RADIUS Authorization

When authentication succeeds, the RADIUS protocol returns user authorizations in the access-accept message sent by a RADIUS server. For more information about configuring authentication, see the [“Configuring Authentication for Network Access”](#) section on page 16-1.

When you configure the security appliance to authenticate users for network access, you are also implicitly enabling RADIUS authorizations; therefore, this section contains no information about configuring RADIUS authorization on the security appliance. It does provide information about how the security appliance handles ACL information received from RADIUS servers.

You can configure a RADIUS server to download an ACL to the security appliance or an ACL name at the time of authentication. The user is authorized to do only what is permitted in the user-specific ACL.



Note If you have used the **access-group** command to apply ACLs to interfaces, be aware of the following effects of the **per-user-override** keyword on authorization by user-specific ACLs:

- Without the **per-user-override** keyword, traffic for a user session must be permitted by both the interface ACL and the user-specific ACL.
- With the **per-user-override** keyword, the user-specific ACL determines what is permitted.

For more information, see the **access-group** command entry in the *Cisco Security Appliance Command Reference*.

This section includes the following topics:

- [Configuring a RADIUS Server to Send Downloadable Access Control Lists, page 16-8](#)
- [Configuring a RADIUS Server to Download Per-User Access Control List Names, page 16-11](#)

Configuring a RADIUS Server to Send Downloadable Access Control Lists

This section describes how to configure Cisco Secure ACS or a third-party RADIUS server, and includes the following topics:

- [About the Downloadable ACL Feature and Cisco Secure ACS, page 16-8](#)
- [Configuring Cisco Secure ACS for Downloadable ACLs, page 16-9](#)
- [Configuring Any RADIUS Server for Downloadable ACLs, page 16-10](#)
- [Converting Wildcard Netmask Expressions in Downloadable ACLs, page 16-11](#)

About the Downloadable ACL Feature and Cisco Secure ACS

Downloadable ACLs is the most scalable means of using Cisco Secure ACS to provide the appropriate ACLs for each user. It provides the following capabilities:

- Unlimited ACL size—Downloadable ACLs are sent using as many RADIUS packets as required to transport the full ACL from Cisco Secure ACS to the security appliance.
- Simplified and centralized management of ACLs—Downloadable ACLs enable you to write a set of ACLs once and apply it to many user or group profiles and distribute it to many security appliances.

This approach is most useful when you have very large ACL sets that you want to apply to more than one Cisco Secure ACS user or group; however, its ability to simplify Cisco Secure ACS user and group management makes it useful for ACLs of any size.

The security appliance receives downloadable ACLs from Cisco Secure ACS using the following process:

1. The security appliance sends a RADIUS authentication request packet for the user session.
2. If Cisco Secure ACS successfully authenticates the user, Cisco Secure ACS returns a RADIUS access-accept message that contains the internal name of the applicable downloadable ACL. The Cisco IOS `cisco-av-pair` RADIUS VSA (vendor 9, attribute 1) contains the following attribute-value pair to identify the downloadable ACL set:

```
ACS: CiscoSecure-Defined-ACL=acl-set-name
```

where *acl-set-name* is the internal name of the downloadable ACL, which is a combination of the name assigned to the ACL by the Cisco Secure ACS administrator and the date and time that the ACL was last modified.

3. The security appliance examines the name of the downloadable ACL and determines if it has previously received the named downloadable ACL.
 - If the security appliance has previously received the named downloadable ACL, communication with Cisco Secure ACS is complete and the security appliance applies the ACL to the user session. Because the name of the downloadable ACL includes the date and time it was last modified, matching the name sent by Cisco Secure ACS to the name of an ACL previously downloaded means that the security appliance has the most recent version of the downloadable ACL.

- If the security appliance has not previously received the named downloadable ACL, it may have an out-of-date version of the ACL or it may not have downloaded any version of the ACL. In either case, the security appliance issues a RADIUS authentication request using the downloadable ACL name as the username in the RADIUS request and a null password attribute. In a cisco-av-pair RADIUS VSA, the request also includes the following attribute-value pairs:

```
AAA:service=ip-admission
AAA:event=acl-download
```

In addition, the security appliance signs the request with the Message-Authenticator attribute (IETF RADIUS attribute 80).

4. Upon receipt of a RADIUS authentication request that has a username attribute containing the name of a downloadable ACL, Cisco Secure ACS authenticates the request by checking the Message-Authenticator attribute. If the Message-Authenticator attribute is missing or incorrect, Cisco Secure ACS ignores the request. The presence of the Message-Authenticator attribute prevents malicious use of a downloadable ACL name to gain unauthorized network access. The Message-Authenticator attribute and its use are defined in RFC 2869, RADIUS Extensions, available at <http://www.ietf.org>.
5. If the ACL required is less than approximately 4 KB in length, Cisco Secure ACS responds with an access-accept message containing the ACL. The largest ACL that can fit in a single access-accept message is slightly less than 4 KB because some of the message must be other required attributes.

Cisco Secure ACS sends the downloadable ACL in a cisco-av-pair RADIUS VSA. The ACL is formatted as a series of attribute-value pairs that each contain an ACE and are numbered serially:

```
ip:inacl#1=ACE-1
ip:inacl#2=ACE-2
.
.
ip:inacl#n=ACE-n
```

An example of an attribute-value pair follows:

```
ip:inacl#1=permit tcp 10.1.0.0 255.0.0.0 10.0.0.0 255.0.0.0
```

6. If the ACL required is more than approximately 4 KB in length, Cisco Secure ACS responds with an access-challenge message that contains a portion of the ACL, formatted as described above, and an State attribute (IETF RADIUS attribute 24), which contains control data used by Cisco Secure ACS to track the progress of the download. Cisco Secure ACS fits as many complete attribute-value pairs into the cisco-av-pair RADIUS VSA as it can without exceeding the maximum RADIUS message size.

The security appliance stores the portion of the ACL received and responds with another access-request message containing the same attributes as the first request for the downloadable ACL plus a copy of the State attribute received in the access-challenge message.

This repeats until Cisco Secure ACS sends the last of the ACL in an access-accept message.

Configuring Cisco Secure ACS for Downloadable ACLs

You can configure downloadable ACLs on Cisco Secure ACS as a shared profile component and then assign the ACL to a group or to an individual user.

The ACL definition consists of one or more security appliance commands that are similar to the extended **access-list** command (see the “Adding an Extended Access List” section on page 13-5), except without the following prefix:

```
access-list acl_name extended
```

The following example is a downloadable ACL definition on Cisco Secure ACS version 3.3:

```

+-----+
| Shared profile Components
|
|     Downloadable IP ACLs Content
|
| Name:     acs_ten_acl
|
|     ACL Definitions
|
| permit tcp any host 10.0.0.254
| permit udp any host 10.0.0.254
| permit icmp any host 10.0.0.254
| permit tcp any host 10.0.0.253
| permit udp any host 10.0.0.253
| permit icmp any host 10.0.0.253
| permit tcp any host 10.0.0.252
| permit udp any host 10.0.0.252
| permit icmp any host 10.0.0.252
| permit ip any any
+-----+

```

For more information about creating downloadable ACLs and associating them with users, see the user guide for your version of Cisco Secure ACS.

On the security appliance, the downloaded ACL has the following name:

```
#ACSACL#-ip-acl_name-number
```

The *acl_name* argument is the name that is defined on Cisco Secure ACS (*acs_ten_acl* in the preceding example), and *number* is a unique version ID generated by Cisco Secure ACS.

The downloaded ACL on the security appliance consists of the following lines:

```

access-list #ACSACL#-ip-asa-acs_ten_acl-3b5385f7 permit tcp any host 10.0.0.254
access-list #ACSACL#-ip-asa-acs_ten_acl-3b5385f7 permit udp any host 10.0.0.254
access-list #ACSACL#-ip-asa-acs_ten_acl-3b5385f7 permit icmp any host 10.0.0.254
access-list #ACSACL#-ip-asa-acs_ten_acl-3b5385f7 permit tcp any host 10.0.0.253
access-list #ACSACL#-ip-asa-acs_ten_acl-3b5385f7 permit udp any host 10.0.0.253
access-list #ACSACL#-ip-asa-acs_ten_acl-3b5385f7 permit icmp any host 10.0.0.253
access-list #ACSACL#-ip-asa-acs_ten_acl-3b5385f7 permit tcp any host 10.0.0.252
access-list #ACSACL#-ip-asa-acs_ten_acl-3b5385f7 permit udp any host 10.0.0.252
access-list #ACSACL#-ip-asa-acs_ten_acl-3b5385f7 permit icmp any host 10.0.0.252
access-list #ACSACL#-ip-asa-acs_ten_acl-3b5385f7 permit ip any any

```

Configuring Any RADIUS Server for Downloadable ACLs

You can configure any RADIUS server that supports Cisco IOS RADIUS VSAs to send user-specific ACLs to the security appliance in a Cisco IOS RADIUS *cisco-av-pair* VSA (vendor 9, attribute 1).

In the *cisco-av-pair* VSA, configure one or more ACEs that are similar to the **access-list extended** command (see the “Adding an Extended Access List” section on page 13-5), except that you replace the following command prefix:

```
access-list acl_name extended
```

with the following text:

```
ip:inacl#nnn=
```

The *nnn* argument is a number in the range from 0 to 999999999 that identifies the order of the command statement to be configured on the security appliance. If this parameter is omitted, the sequence value is 0, and the order of the ACEs inside the cisco-av-pair RADIUS VSA is used.

The following example is an ACL definition as it should be configured for a cisco-av-pair VSA on a RADIUS server:

```
ip:inacl#1=permit tcp 10.1.0.0 255.0.0.0 10.0.0.0 255.0.0.0
ip:inacl#99=deny tcp any any
ip:inacl#2=permit udp 10.1.0.0 255.0.0.0 10.0.0.0 255.0.0.0
ip:inacl#100=deny udp any any
ip:inacl#3=permit icmp 10.1.0.0 255.0.0.0 10.0.0.0 255.0.0.0
```

For information about making unique per user the ACLs that are sent in the cisco-av-pair attribute, see the documentation for your RADIUS server.

On the security appliance, the downloaded ACL name has the following format:

```
AAA-user-username
```

The *username* argument is the name of the user that is being authenticated.

The downloaded ACL on the security appliance consists of the following lines. Notice the order based on the numbers identified on the RADIUS server.

```
access-list AAA-user-bcham34-79AD4A08 permit tcp 10.1.0.0 255.0.0.0 10.0.0.0 255.0.0.0
access-list AAA-user-bcham34-79AD4A08 permit udp 10.1.0.0 255.0.0.0 10.0.0.0 255.0.0.0
access-list AAA-user-bcham34-79AD4A08 permit icmp 10.1.0.0 255.0.0.0 10.0.0.0 255.0.0.0
access-list AAA-user-bcham34-79AD4A08 deny tcp any any
access-list AAA-user-bcham34-79AD4A08 deny udp any any
```

Downloaded ACLs have two spaces between the word “access-list” and the name. These spaces serve to differentiate a downloaded ACL from a local ACL. In this example, “79AD4A08” is a hash value generated by the security appliance to help determine when ACL definitions have changed on the RADIUS server.

Converting Wildcard Netmask Expressions in Downloadable ACLs

If a RADIUS server provides downloadable ACLs to Cisco VPN 3000 Series Concentrators as well as to the security appliance, you may need the security appliance to convert wildcard netmask expressions to standard netmask expressions. This is because Cisco VPN 3000 Series Concentrators support wildcard netmask expressions but the security appliance only supports standard netmask expressions. Configuring the security appliance to convert wildcard netmask expressions helps minimize the effects of these differences upon how you configure downloadable ACLs on your RADIUS servers. Translation of wildcard netmask expressions means that downloadable ACLs written for Cisco VPN 3000 Series Concentrators can be used by the security appliance without altering the configuration of the downloadable ACLs on the RADIUS server.

You configure ACL netmask conversion on a per server basis, using the **acl-netmask-convert** command, available in the AAA-server configuration mode. For more information about configuring a RADIUS server, see “[Identifying AAA Server Groups and Servers](#)” section on page 10-11. For more information about the **acl-netmask-convert** command, see the *Cisco Security Appliance Command Reference*.

Configuring a RADIUS Server to Download Per-User Access Control List Names

To download a name for an ACL that you already created on the security appliance from the RADIUS server when a user authenticates, configure the IETF RADIUS filter-id attribute (attribute number 11) as follows:

```
filter-id=acl_name
```

**Note**

In Cisco Secure ACS, the value for filter-id attributes are specified in boxes in the HTML interface, omitting **filter-id=** and entering only *acl_name*.

For information about making unique per user the filter-id attribute value, see the documentation for your RADIUS server.

See the [“Adding an Extended Access List” section on page 13-5](#) to create an ACL on the security appliance.

Configuring Accounting for Network Access

The security appliance can send accounting information to a RADIUS or TACACS+ server about any TCP or UDP traffic that passes through the security appliance. If that traffic is also authenticated, then the AAA server can maintain accounting information by username. If the traffic is not authenticated, the AAA server can maintain accounting information by IP address. Accounting information includes when sessions start and stop, username, the number of bytes that pass through the security appliance for the session, the service used, and the duration of each session.

To configure accounting, perform the following steps:

Step 1 If you want the security appliance to provide accounting data per user, you must enable authentication. For more information, see the [“Enabling Network Access Authentication” section on page 16-3](#). If you want the security appliance to provide accounting data per IP address, enabling authentication is not necessary and you can continue to the next step.

Step 2 Using the **access-list** command, create an ACL that identifies the source addresses and destination addresses of traffic you want accounted. For steps, see the [“Adding an Extended Access List” section on page 13-5](#).

The **permit** ACEs mark matching traffic for authorization, while **deny** entries exclude matching traffic from authorization.

**Note**

If you have configured authentication and want accounting data for all the traffic being authenticated, you can use the same ACL you created for use with the **aaa authentication match** command.

Step 3 To enable accounting, enter the following command:

```
hostname/contexta(config)# aaa accounting match acl_name interface_name server_group
```

**Note**

Alternatively, you can use the **aaa accounting include** command (which identifies traffic within the command) but you cannot use both methods in the same configuration. See the *Cisco Security Appliance Command Reference* for more information.

The following commands authenticate, authorize, and account for inside Telnet traffic. Telnet traffic to servers other than 209.165.201.5 can be authenticated alone, but traffic to 209.165.201.5 requires authorization and accounting.

```
hostname/contexta(config)# aaa-server AuthOutbound protocol tacacs+
hostname/contexta(config-aaa-server-group)# exit
hostname/contexta(config)# aaa-server AuthOutbound (inside) host 10.1.1.1
hostname/contexta(config-aaa-server-host)# key TACPlusUauthKey
hostname/contexta(config-aaa-server-host)# exit
hostname/contexta(config)# access-list TELNET_AUTH extended permit tcp any any eq telnet
hostname/contexta(config)# access-list SERVER_AUTH extended permit tcp any host
209.165.201.5 eq telnet
hostname/contexta(config)# aaa authentication match TELNET_AUTH inside AuthOutbound
hostname/contexta(config)# aaa authorization match SERVER_AUTH inside AuthOutbound
hostname/contexta(config)# aaa accounting match SERVER_AUTH inside AuthOutbound
```

Using MAC Addresses to Exempt Traffic from Authentication and Authorization

The security appliance can exempt from authentication and authorization any traffic from specific MAC addresses.

For example, if the security appliance authenticates TCP traffic originating on a particular network but you want to allow unauthenticated TCP connections from a specific server, you would use the **mac-list** command to create a rule permitting traffic from the MAC address of the server and then use the **aaa mac-exempt** command to exempt from authentication and authorization any traffic from the server specified by the MAC list.

Conversely, if traffic from a particular computer should never be permitted regardless of authentication, you can use the MAC address of the computer in a **mac-list** command that denies traffic from the MAC address. The use of the **aaa mac-exempt** command in this scenario would disallow traffic from the computer even though authentication rules would otherwise permit the traffic.

To use MAC addresses to exempt traffic from authentication and authorization, perform the following steps:

Step 1 To configure a MAC list, enter the following command:

```
hostname/contexta(config)# mac-list id {deny | permit} mac macmask
```

where *id* is the hexadecimal number that you assign to the MAC list, *mac* is the MAC address of the computer whose traffic you want to permit or deny, and *macmask* is a MAC address mask. For more information about the **mac-list** command, see the *Cisco Security Appliance Command Reference*.

Step 2 To exempt traffic for the MAC addresses specified in a particular MAC list, enter the following command:

```
hostname/contexta(config)# aaa mac-exempt match id
```

where *id* is the string identifying the MAC list containing the MAC addresses whose traffic is to be exempt from authentication and authorization.

The following commands create two MAC lists, each consisting of a single MAC address. One permits traffic from its MAC address while the other denies traffic from its MAC address. The final two commands configure the security appliance to exempt from authentication and authorization any traffic originating from the MAC addresses in the two lists.

```
hostname/contexta(config)# mac-list adc permit 00a0.cp5d.0282 ffff.ffff.ffff
hostname/contexta(config)# mac-list ac deny 0061.54ff.b440 ffff.ffff.ffff
hostname/contexta(config)# aaa mac-exempt match adc
hostname/contexta(config)# aaa mac-exempt match ac
```



Applying Filtering Services

This chapter describes ways to filter web traffic to reduce security risks or prevent inappropriate use. This chapter contains the following sections:

- [Filtering Overview, page 17-1](#)
- [Filtering ActiveX Objects, page 17-2](#)
- [Filtering Java Applets, page 17-3](#)
- [Filtering with an External Server, page 17-4](#)
- [Filtering HTTP URLs, page 17-7](#)
- [Filtering HTTPS URLs, page 17-8](#)
- [Filtering FTP Requests, page 17-9](#)
- [Viewing Filtering Statistics and Configuration, page 17-10](#)

Filtering Overview

This section describes how filtering can provide greater control over traffic passing through the security appliance. Filtering can be used in two distinct ways:

- Filtering ActiveX objects or Java applets
- Filtering with an external filtering server

Instead of blocking access altogether, you can remove specific undesirable objects from HTTP traffic, such as ActiveX objects or Java applets, that may pose a security threat in certain situations.

You can also use URL filtering to direct specific traffic to an external filtering server, such as N2H2 Sentian or Websense filtering server. Filtering servers can block traffic to specific sites or types of sites, as specified by the security policy.

Because URL filtering is CPU-intensive, using an external filtering server ensures that the throughput of other traffic is not affected. However, depending on the speed of your network and the capacity of your URL filtering server, the time required for the initial connection may be noticeably slower when filtering traffic with an external filtering server.

Filtering ActiveX Objects

This section describes how to apply filtering to remove ActiveX objects from HTTP traffic passing through the firewall. This section includes the following topics:

- [Overview, page 17-2](#)
- [Enabling ActiveX Filtering, page 17-2](#)

Overview

ActiveX objects may pose security risks because they can contain code intended to attack hosts and servers on a protected network. You can disable ActiveX objects with ActiveX filtering.

ActiveX controls, formerly known as OLE or OCX controls, are components you can insert in a web page or other application. These controls include custom forms, calendars, or any of the extensive third-party forms for gathering or displaying information. As a technology, ActiveX creates many potential problems for network clients including causing workstations to fail, introducing network security problems, or being used to attack servers.

The **filteractivex** command blocks the HTML `<object>` commands by commenting them out within the HTML web page. ActiveX filtering of HTML files is performed by selectively replacing the `<APPLET>` and `</APPLET>` and `<OBJECT CLASSID>` and `</OBJECT>` tags with comments. Filtering of nested tags is supported by converting top-level tags to comments.



Caution

This command also blocks any Java applets, image files, or multimedia objects that are embedded in object tags.

If the `<object>` or `</object>` HTML tags split across network packets or if the code in the tags is longer than the number of bytes in the MTU, security appliance cannot block the tag.

ActiveX blocking does not occur when users access an IP address referenced by the **alias** command.

Enabling ActiveX Filtering

This section describes how to remove ActiveX objects in HTTP traffic passing through the security appliance. To remove ActiveX objects, enter the following command in global configuration mode:

```
hostname(config)# filteractivex port[-port] local_ip local_mask foreign_ip foreign_mask
```

To use this command, replace *port* with the TCP port to which filtering is applied. Typically, this is port 80, but other values are accepted. The **http** or **url** literal can be used for port 80. You can specify a range of ports by using a hyphen between the starting port number and the ending port number.

The local IP address and mask identify one or more internal hosts that are the source of the traffic to be filtered. The foreign address and mask specify the external destination of the traffic to be filtered.

You can set either address to **0.0.0.0** (or in shortened form, **0**) to specify all hosts. You can use **0.0.0.0** for either mask (or in shortened form, **0**) to specify all hosts.

The following example specifies that ActiveX objects are blocked on all outbound connections:

```
hostname(config)# filteractivex 80 0 0 0 0
```

This command specifies that the ActiveX object blocking applies to web traffic on port 80 from any local host and for connections to any foreign host.

To remove the configuration, use the **no** form of the command, as in the following example:

```
hostname(config)# no filter activex 80 0 0 0 0
```

Filtering Java Applets

This section describes how to apply filtering to remove Java applets from HTTP traffic passing through the firewall. This section includes the following topics:

- [Overview, page 17-3](#)
- [Enabling Java Applet Filtering, page 17-3](#)

Overview

Java applets may pose security risks because they can contain code intended to attack hosts and servers on a protected network. You can remove Java applets with the **filter java** command.

The **filter java** command filters out Java applets that return to the security appliance from an outbound connection. The user still receives the HTML page, but the web page source for the applet is commented out so that the applet cannot execute.



Note

Use the **filter activex** command to remove Java applets that are embedded in <object> tags.

Enabling Java Applet Filtering

To remove Java applets in HTTP traffic passing through the firewall, enter the following command in global configuration mode:

```
hostname(config)# filter java port[-port] local_ip local_mask foreign_ip foreign_mask
```

To use this command, replace *port* with the TCP port to which filtering is applied. Typically, this is port 80, but other values are accepted. The **http** or **url** literal can be used for port 80. You can specify a range of ports by using a hyphen between the starting port number and the ending port number.

The local IP address and mask identify one or more internal hosts that are the source of the traffic to be filtered. The foreign address and mask specify the external destination of the traffic to be filtered.

You can set either address to **0.0.0.0** (or in shortened form, **0**) to specify all hosts. You can use **0.0.0.0** for either mask (or in shortened form, **0**) to specify all hosts.

You can set either address to **0.0.0.0** (or in shortened form, **0**) to specify all hosts. You can use **0.0.0.0** for either mask (or in shortened form, **0**) to specify all hosts.

The following example specifies that Java applets are blocked on all outbound connections:

```
hostname(config)# filter java 80 0 0 0 0
```

This command specifies that the Java applet blocking applies to web traffic on port 80 from any local host and for connections to any foreign host.

The following example blocks downloading of Java applets to a host on a protected network:

```
hostname(config)# filter java http 192.168.3.3 255.255.255.255 0 0
```

This command prevents host 192.168.3.3 from downloading Java applets.

To remove the configuration, use the **no** form of the command, as in the following example:

```
hostname(config)# no filter java http 192.168.3.3 255.255.255.255 0 0
```

Filtering with an External Server

This section provides an overview of filtering with an external server and describes the configuration required regardless of the type of server you are using or the type of content you are filtering. This section includes the following topics:

- [Filtering Overview, page 17-4](#)
- [General Procedure, page 17-5](#)
- [Identifying the Filtering Server, page 17-5](#)
- [Buffering the Content Server Response, page 17-6](#)
- [Caching Server Addresses, page 17-7](#)

Filtering Overview

You can apply filtering to connection requests originating from a more secure network to a less secure network. Although you can use ACLs to prevent outbound access to specific content servers, managing usage this way is difficult because of the size and dynamic nature of the Internet. You can simplify configuration and improve security appliance performance by using a separate server running one of the following Internet filtering products:

- Websense Enterprise for filtering HTTP, HTTPS, and FTP.
- Sentian by N2H2 for filtering HTTP only. (Although some versions of Sentian support HTTPS, the security appliance only supports filtering HTTP with Sentian.)

Although security appliance performance is less affected when using an external server, users may notice longer access times to websites or FTP servers when the filtering server is remote from the security appliance.

When filtering is enabled and a request for content is directed through the security appliance, the request is sent to the content server and to the filtering server at the same time. If the filtering server allows the connection, the security appliance forwards the response from the content server to the originating client. If the filtering server denies the connection, the security appliance drops the response and sends a message or return code indicating that the connection was not successful.

If user authentication is enabled on the security appliance, then the security appliance also sends the user name to the filtering server. The filtering server can use user-specific filtering settings or provide enhanced reporting regarding usage.

General Procedure

The following steps summarize the procedure for enabling filtering with an external filtering server. To enable filtering with an external filtering server, perform the following steps:

-
- Step 1** Identify the filtering server. Refer to the following section:
[Identifying the Filtering Server, page 17-5](#)
- Step 2** (Optional) Buffer responses from the content server. Refer to the following section:
[Buffering the Content Server Response, page 17-6](#)
- Step 3** (Optional) Cache content server addresses to improve performance. Refer to the following section:
[Caching Server Addresses, page 17-7](#)
- Step 4** Configure HTTP filtering and the different options available. Refer to the following section:
[Configuring HTTP Filtering, page 17-7](#)
- Step 5** Configure HTTPS filtering (Websense only). Refer to the following section:
[Filtering HTTPS URLs, page 17-8](#)
- Step 6** Configure FTP filtering (Websense only). Refer to the following section:
[Filtering FTP Requests, page 17-9](#)
- Step 7** Configure the external filtering server. Refer to the following websites:
- <http://www.websense.com>
 - <http://www.n2h2.com>
-

Identifying the Filtering Server

You can identify up to four filtering servers per context. The security appliance uses the servers in order until a server responds. You can only configure a single type of server (Websense or N2H2) in your configuration.

**Note**

You must add the filtering server before you can configure filtering for HTTP or HTTPS with the **filter** command. If you remove the filtering servers from the configuration, then all **filter** commands are also removed.

Identify the address of the filtering server using the **url-server** command:

For Websense:

```
hostname(config)# url-server (if_name) host local_ip [timeout seconds] [protocol TCP | UDP  
version 1|4 [connections num_conns] ]
```

For N2H2:

```
hostname(config)# url-server (if_name) vendor n2h2 host local_ip[:port number] [timeout  
seconds] [protocol TCP connections number | UDP [connections num_conns]]
```

Replace *if_name* with the name of the security appliance interface that is connected to the filtering server (the default is **inside**). Replace *local_ip* with the IP address of the filtering server. Replace *seconds* with the number of seconds the security appliance should keep trying to connect to the filtering server.

**Note**

The default port is 4005. This is the default port used by the N2H2 server to communicate to the security appliance via TCP or UDP. For information on changing the default port, please refer to the *Filtering by N2H2 Administrator's Guide*.

For example, to identify a single Websense filtering server, enter the following command:

```
hostname(config)# url-server (perimeter) host 10.0.1.1 protocol TCP version 4
```

This identifies a Websense filtering server with the IP address 10.0.1.1 on a perimeter interface of the security appliance. Version 4, which is enabled in this example, is recommended by Websense because it supports caching.

To identify redundant N2H2 Sentian servers, enter the following commands:

```
hostname(config)# url-server (perimeter) vendor n2h2 host 10.0.1.1
hostname(config)# url-server (perimeter) vendor n2h2 host 10.0.1.2
```

This identifies two Sentian filtering servers, both on a perimeter interface of the security appliance.

Buffering the Content Server Response

When a user issues a request to connect to a content server, the security appliance sends the request to the content server and to the filtering server at the same time. If the filtering server does not respond before the content server, the server response is dropped. This delays the web server response from the point of view of the web client because the client must reissue the request.

By enabling the HTTP response buffer, replies from web content servers are buffered and the responses are forwarded to the requesting client if the filtering server allows the connection. This prevents the delay that might otherwise occur.

To configure buffering for responses to HTTP or FTP requests, perform the following steps:

- Step 1** To enable buffering of responses for HTTP or FTP requests that are pending a response from the filtering server, enter the following command:

```
hostname(config)# url-block block block-buffer-limit
```

Replace *block-buffer-limit* with the maximum number of blocks that will be buffered.



Note Buffering URLs longer than 1159 bytes is only supported for the Websense filtering server.

- Step 2** To configure the maximum memory available for buffering pending URLs (and for buffering long URLs with Websense), enter the following command:

```
hostname(config)# url-block url-mempool memory-pool-size
```

Replace *memory-pool-size* with a value from 2 to 10240 for a maximum memory allocation of 2 KB to 10 MB.

Caching Server Addresses

After a user accesses a site, the filtering server can allow the security appliance to cache the server address for a certain amount of time, as long as every site hosted at the address is in a category that is permitted at all times. Then, when the user accesses the server again, or if another user accesses the server, the security appliance does not need to consult the filtering server again.

**Note**

Requests for cached IP addresses are not passed to the filtering server and are not logged. As a result, this activity does not appear in any reports. You can accumulate Websense run logs before using the **url-cache** command.

Use the **url-cache** command if needed to improve throughput, as follows:

```
hostname(config)# url-cache dst | src_dst size
```

Replace *size* with a value for the cache size within the range 1 to 128 (KB).

Use the **dst** keyword to cache entries based on the URL destination address. Select this mode if all users share the same URL filtering policy on the Websense server.

Use the **src_dst** keyword to cache entries based on both the source address initiating the URL request as well as the URL destination address. Select this mode if users do not share the same URL filtering policy on the Websense server.

Filtering HTTP URLs

This section describes how to configure HTTP filtering with an external filtering server. This section includes the following topics:

- [Configuring HTTP Filtering, page 17-7](#)
- [Enabling Filtering of Long HTTP URLs, page 17-8](#)
- [Truncating Long HTTP URLs, page 17-8](#)
- [Exempting Traffic from Filtering, page 17-8](#)

Configuring HTTP Filtering

You must identify and enable the URL filtering server before enabling HTTP filtering.

When the filtering server approves an HTTP connection request, the security appliance allows the reply from the web server to reach the originating client. If the filtering server denies the request, the security appliance redirects the user to a block page, indicating that access was denied.

To enable HTTP filtering, enter the following command:

```
hostname(config)# filter url [http | port[-port] local_ip local_mask foreign_ip  
foreign_mask] [allow] [proxy-block]
```

Replace *port* with one or more port numbers if a different port than the default port for HTTP (80) is used. Replace *local_ip* and *local_mask* with the IP address and subnet mask of a user or subnetwork making requests. Replace *foreign_ip* and *foreign_mask* with the IP address and subnet mask of a server or subnetwork responding to requests.

The **allow** option causes the security appliance to forward HTTP traffic without filtering when the primary filtering server is unavailable. Use the **proxy-block** command to drop all requests to proxy servers.

Enabling Filtering of Long HTTP URLs

By default, the security appliance considers an HTTP URL to be a long URL if it is greater than 1159 characters. For Websense servers, you can increase the maximum length allowed.

(Websense only) Configure the maximum size of a single URL with the following command:

```
hostname(config)# url-block url-size long-url-size
```

Replace *long-url-size* with a value from 2 to 4 for a maximum URL size of 2 KB to 4 KB. The default value is 2.

Truncating Long HTTP URLs

By default, if a URL exceeds the maximum permitted size, then it is dropped. To avoid this, you can set the security appliance to truncate a long URL by entering the following command:

```
hostname(config)# filter url [longurl-truncate | longurl-deny | cgi-truncate]
```

The **longurl-truncate** option causes the security appliance to send only the hostname or IP address portion of the URL for evaluation to the filtering server when the URL is longer than the maximum length permitted. Use the **longurl-deny** option to deny outbound URL traffic if the URL is longer than the maximum permitted.

Use the **cgi-truncate** option to truncate CGI URLs to include only the CGI script location and the script name without any parameters. Many long HTTP requests are CGI requests. If the parameters list is very long, waiting and sending the complete CGI request including the parameter list can use up memory resources and affect firewall performance.

Exempting Traffic from Filtering

To exempt specific traffic from filtering, enter the following command:

```
hostname(config)# filter url except source_ip source_mask dest_ip dest_mask
```

For example, the following commands cause all HTTP requests to be forwarded to the filtering server except for those from 10.0.2.54.

```
hostname(config)# filter url http 0 0 0 0
hostname(config)# filter url except 10.0.2.54 255.255.255.255 0 0
```

Filtering HTTPS URLs

You must identify and enable the URL filtering server before enabling HTTPS filtering.



Note

Filtering HTTPS URLs is only supported for Websense filtering servers.

Because HTTPS content is encrypted, the security appliance sends the URL lookup without directory and filename information. When the filtering server approves an HTTPS connection request, the security appliance allows the completion of SSL connection negotiation and allows the reply from the web server to reach the originating client. If the filtering server denies the request, the security appliance prevents the completion of SSL connection negotiation. The browser displays an error message such as “The Page or the content cannot be displayed.”

**Note**

The security appliance does not provide an authentication prompt for HTTPS, so a user must authenticate with the security appliance using HTTP or FTP before accessing HTTPS servers.

To enable HTTPS filtering, enter the following command:

```
hostname(config)# filter https port localIP local_mask foreign_IP foreign_mask [allow]
```

Replace *port* with the port number if a different port than the default port for HTTPS (443) is used. Replace *local_ip* and *local_mask* with the IP address and subnet mask of a user or subnetwork making requests. Replace *foreign_ip* and *foreign_mask* with the IP address and subnet mask of a server or subnetwork responding to requests.

The **allow** option causes the security appliance to forward HTTPS traffic without filtering when the primary filtering server is unavailable.

Filtering FTP Requests

You must identify and enable the URL filtering server before enabling FTP filtering.

**Note**

Filtering FTP URLs is only supported for Websense filtering servers.

When the filtering server approves an FTP connection request, the security appliance allows the successful FTP return code to reach originating client. For example, a successful return code is “250: CWD command successful.” If the filtering server denies the request, alters the FTP return code to show that the connection was denied. For example, the security appliance changes code 250 to “550 Requested file is prohibited by URL filtering policy.”

To enable FTP filtering, enter the following command:

```
hostname(config)# filter ftp port localIP local_mask foreign_IP foreign_mask [allow]  
[interact-block]
```

Replace *port* with the port number if a different port than the default port for FTP (21) is used. Replace *local_ip* and *local_mask* with the IP address and subnet mask of a user or subnetwork making requests. Replace *foreign_ip* and *foreign_mask* with the IP address and subnet mask of a server or subnetwork responding to requests.

The **allow** option causes the security appliance to forward HTTPS traffic without filtering when the primary filtering server is unavailable.

Use the **interact-block** option to prevent interactive FTP sessions that do not provide the entire directory path. An interactive FTP client allows the user to change directories without typing the entire path. For example, the user might enter **cd ./files** instead of **cd /public/files**.

Viewing Filtering Statistics and Configuration

This section describes how to monitor filtering statistics. This section includes the following topics:

- [Viewing Filtering Server Statistics, page 17-10](#)
- [Viewing Buffer Configuration and Statistics, page 17-10](#)
- [Viewing Caching Statistics, page 17-11](#)
- [Viewing Filtering Performance Statistics, page 17-11](#)
- [Viewing Filtering Configuration, page 17-12](#)

Viewing Filtering Server Statistics

To show information about the filtering server, enter the following command:

```
hostname# show url-server
```

The following is sample output from the **show url-server** command:

```
hostname# show url-server
url-server (outside) vendor n2h2 host 128.107.254.202 port 4005 timeout 5 protocol TCP
```

To show information about the filtering server or to show statistics, enter the following command:

The following is sample output from the **show url-server stats** command, which shows filtering statistics:

```
hostname# show url-server stats
URL Server Statistics:
-----
Vendor                websense
URLs total/allowed/denied 50/35/15
HTTPSS total/allowed/denied 1/1/0
FTPs total/allowed/denied 3/1/2

URL Server Status:
-----
10.130.28.18          UP

URL Packets Sent and Received Stats:
-----
Message              Sent      Received
STATUS_REQUEST      65155    34773
LOOKUP_REQUEST       0         0
LOG_REQUEST          0         NA
-----
```

Viewing Buffer Configuration and Statistics

The **show url-block** command displays the number of packets held in the url-block buffer and the number (if any) dropped due to exceeding the buffer limit or retransmission.

The following is sample output from the **show url-block** command:

```
hostname# show url-block
url-block url-mempool 128
url-block url-size 4
url-block block 128
```

This shows the configuration of the URL block buffer.

The following is sample output from the **show url-block block statistics** command:

```
hostname# show url-block block statistics

URL Pending Packet Buffer Stats with max block 128
-----
Cumulative number of packets held:          896
Maximum number of packets held (per URL):   3
Current number of packets held (global):    38
Packets dropped due to
    exceeding url-block buffer limit:       7546
    HTTP server retransmission:            10
Number of packets released back to client:  0
```

This shows the URL block statistics.

Viewing Caching Statistics

The following is sample output from the **show url-cache stats** command:

```
hostname# show url-cache stats
URL Filter Cache Stats
-----
Size :      128KB
Entries :   1724
In Use :    456
Lookups :   45
Hits :      8
```

This shows how the cache is used.

Viewing Filtering Performance Statistics

The following is sample output from the **show perfmon** command:

```
hostname# show perfmon
PERFMON STATS:      Current      Average
Xlates              0/s        0/s
Connections         0/s        2/s
TCP Conns           0/s        2/s
UDP Conns           0/s        0/s
URL Access        0/s       2/s
URL Server Req   0/s       3/s
TCP Fixup           0/s        0/s
TCPIntercept        0/s        0/s
HTTP Fixup          0/s        3/s
FTP Fixup           0/s        0/s
AAA Authen          0/s        0/s
AAA Author          0/s        0/s
AAA Account         0/s        0/s
```

This shows URL filtering performance statistics, along with other performance statistics. The filtering statistics are shown in the URL Access and URL Server Req rows.

Viewing Filtering Configuration

The following is sample output from the **show filter** command:

```
hostname# show filter
filter url http 0.0.0.0 0.0.0.0 0.0.0.0 0.0.0.0
```



Using Modular Policy Framework

This chapter describes how to use Modular Policy Framework to create security policies for TCP and general connection settings, inspections, IPS, and QoS.

This chapter includes the following sections:

- [Modular Policy Framework Overview, page 18-1](#)
- [Identifying Traffic Using a Class Map, page 18-2](#)
- [Defining Actions Using a Policy Map, page 18-4](#)
- [Applying a Policy to an Interface Using a Service Policy, page 18-8](#)
- [Modular Policy Framework Examples, page 18-8](#)

Modular Policy Framework Overview

Modular Policy Framework provides a consistent and flexible way to configure security appliance features in a manner similar to Cisco IOS software QoS CLI. For example, you can use Modular Policy Framework to create a timeout configuration that is specific to a particular TCP application, as opposed to one that applies to all TCP applications.

Modular Policy Framework is supported with these features:

- IPS
- TCP normalization, and connection limits and timeouts
- QoS policing
- QoS priority queue
- Application inspection

Configuring Modular Policy Framework consists of three tasks:

1. Identify the traffic to which you want to apply actions. See [“Identifying Traffic Using a Class Map” section on page 18-2](#).
2. Apply actions to the traffic. See [“Defining Actions Using a Policy Map” section on page 18-4](#).
3. Activate the actions on an interface. See [“Applying a Policy to an Interface Using a Service Policy” section on page 18-8](#).

Default Global Policy

By default, the configuration includes a policy that matches all default application inspection traffic and applies inspection to the traffic on all interfaces (a global policy). You can only apply one global policy, so if you want to alter the global policy, you need to either edit the default policy or disable it and apply a new one.

The default policy configuration includes the following commands:

```
class-map inspection_default
  match default-inspection-traffic
policy-map global_policy
  class inspection_default
    inspect dns maximum-length 512
    inspect ftp
    inspect h323 h225
    inspect h323 ras
    inspect rsh
    inspect smtp
    inspect sqlnet
    inspect skinny
    inspect sunrpc
    inspect xdmcp
    inspect sip
    inspect netbios
    inspect tftp
service-policy global_policy global
```

Identifying Traffic Using a Class Map

A class map identifies traffic to which you want to apply actions. The maximum number of class maps is 255 in single mode or per context in multiple mode. The configuration includes a default class map that the security appliance uses in the default global policy. It is called **inspection_default** and matches the default inspection traffic:

```
class-map inspection_default
  match default-inspection-traffic
```

To define a class map, perform the following steps:

Step 1 Create a class map by entering the following command:

```
hostname(config)# class-map class_map_name
```

where *class_map_name* is a string up to 40 characters in length.

Step 2 (Optional) Add a description to the class map by entering the following command:

```
hostname(config-cmap)# description string
```

Step 3 Define the traffic to include in the class by matching one of the following characteristics. Unless otherwise specified, you can include only one **match** command in the class map.

- Any traffic—You match the class to all traffic.

```
hostname(config-cmap)# match any
```
- Access list—You can match the class to traffic specified by an extended access list. If the security appliance is operating in transparent firewall mode, you can use an EtherType access list.

```
hostname(config-cmap)# match access-list acl_ID
```

For more information about creating access lists, see the “Adding an Extended Access List” section on page 13-5 or the “Adding an EtherType Access List” section on page 13-7.

For information about creating access lists with NAT, see the “IP Addresses Used for Access Lists When You Use NAT” section on page 13-3.

- TCP or UDP destination ports—You can match the class to a single port or a contiguous range of ports.

```
hostname(config-cmap)# match port {tcp | udp} {eq port_num | range port_num port_num}
```



Tip For applications that use multiple, non-contiguous ports, use the **match access-list** command and define an ACE to match each port.

For a list of ports you can specify, see the “TCP and UDP Ports” section on page D-12.

For example, enter the following command to match TCP packets on port 80 (HTTP):

```
hostname(config-cmap)# match tcp eq 80
```

- Default traffic for inspection—You can match the class to the traffic that the security appliance inspects by default.

```
hostname(config-cmap)# match default-inspection-traffic
```

The **match default-inspection-traffic** command specifies the protocols and ports that are inspected by default. See this command in the *Cisco Security Appliance Command Reference* for a list of default inspection traffic. The security appliance includes a default global policy that matches the default inspection traffic, and applies inspection to the traffic on all interfaces.

You can specify a **match access-list** command along with the **match default-inspection-traffic** command to narrow the matched traffic. The class excludes any protocol or port information specified in the **match access-list** command that is already included in the **match default-inspection-traffic** command.

- DSCP value in an IP header—You can match the class to up to eight DSCP values.

```
hostname(config-cmap)# match dscp value1 [value2] [...] [value8]
```

For example, enter the following:

```
hostname(config-cmap)# match dscp af43 cs1 ef
```

- Precedence—You can match the class to up to four precedence values, represented by the TOS byte in the IP header.

```
hostname(config-cmap)# match precedence value1 [value2] [value3] [value4]
```

where *value1* through *value4* can be 0 to 7, corresponding to the possible precedences.

- RTP traffic—You can match the class to RTP traffic.

```
hostname(config-cmap)# match rtp starting_port range
```

The *starting_port* specifies an even-numbered UDP destination port between 2000 and 65534. The *range* specifies the number of additional UDP ports to match above the *starting_port*, between 0 and 16383.

- Tunnel group traffic—You can match the traffic for a tunnel group to which you want to apply QoS.

```
hostname(config-cmap)# match tunnel-group name
```

You can also specify one other match command to refine the traffic match. You can specify any of the preceding commands, except for the **match any**, **match access-list**, or **match default-inspection-traffic** commands. Or you can enter the following command to police each flow:

```
hostname(config-cmap)# match flow ip destination address
```

All traffic going to a unique IP destination address is considered a flow.

The following is an example for the **class-map** command:

```
hostname(config)# access-list udp permit udp any any
hostname(config)# access-list tcp permit tcp any any
hostname(config)# access-list host_foo permit ip any 10.1.1.1 255.255.255.255
hostname(config)# class-map all_udp
hostname(config-cmap)# description "This class-map matches all UDP traffic"
hostname(config-cmap)# match access-list udp
hostname(config-cmap)# exit
hostname(config)# class-map all_tcp
hostname(config-cmap)# description "This class-map matches all TCP traffic"
hostname(config-cmap)# match access-list tcp
hostname(config-cmap)# exit
hostname(config)# class-map all_http
hostname(config-cmap)# description "This class-map matches all HTTP traffic"
hostname(config-cmap)# match port tcp eq http
hostname(config-cmap)# exit
hostname(config)# class-map to_server
hostname(config-cmap)# description "This class-map matches all traffic to server 10.1.1.1"
hostname(config-cmap)# match access-list host_foo
hostname(config-cmap)# exit
```

Defining Actions Using a Policy Map

This section describes how to associate actions with class maps by creating a policy map. This section includes the following topics:

- [Policy Map Overview, page 18-4](#)
- [Default Policy Map, page 18-6](#)
- [Adding a Policy Map, page 18-6](#)

Policy Map Overview

You can identify multiple class maps in a policy map, and you can assign multiple actions from one or more feature types to each class map. Feature types include the following:

- IPS
- TCP normalization, and connection limits and timeouts
- QoS policing
- QoS priority queue
- Application inspection

A packet can match only one class map in the policy map for each feature type. When the packet matches a class map for a feature type, the security appliance does not attempt to match it to any subsequent class maps for that feature type. If the packet matches a subsequent class map for a different feature type, however, then the security appliance also applies the actions for the subsequent class map.

For example, if a packet matches a class map for connection limits, and also matches a class map for application inspection, then both class map actions are applied. If a packet matches a class map for application inspection, but also matches another class map for application inspection, then the second class map actions are not applied.

Actions are applied to traffic bidirectionally or unidirectionally depending on the feature. For features that are applied bidirectionally, all traffic that enters or exits the interface to which you apply the policy map is affected if the traffic matches the class map for both directions.

**Note**

When you use a global policy, all features are unidirectional; features that are normally bidirectionally when applied to a single interface only apply to the ingress of each interface when applied globally. Because the policy is applied to all interfaces, the policy will be applied in both directions so bidirectionality in this case is redundant.

For features that are applied unidirectionally, for example QoS, only traffic that exits the interface to which you apply the policy map is affected. See [Table 1](#) for the directionality of each feature.

Table 1 Feature Directionality

Feature	Single Interface Direction	Global Direction
IPS	Bidirectional	Ingress
TCP normalization, and connection limits and timeouts	Bidirectional	Ingress
QoS policing	Egress	Egress
QoS priority queue	Egress	Egress
Application inspection	Bidirectional	Ingress

The order in which different types of actions in a policy map are performed is independent of the order in which the actions appear in the policy map. Actions are performed in the following order:

- IPS
- TCP normalization, and connection limits and timeouts
- Application inspection
- QoS policing
- QoS priority queue

You can only assign one policy map per interface, but you can apply the same policy map to multiple interfaces.

Default Policy Map

The configuration includes a default policy map that the security appliance uses in the default global policy. It is called **global_policy** and performs inspection on the default inspection traffic. You can only apply one global policy, so if you want to alter the global policy, you need to either edit the default policy or disable it and apply a new one.

The default policy map configuration includes the following commands:

```
policy-map global_policy
class inspection_default
inspect dns maximum-length 512
inspect ftp
inspect h323 h225
inspect h323 ras
inspect rsh
inspect smtp
inspect sqlnet
inspect skinny
inspect sunrpc
inspect xdmcp
inspect sip
inspect netbios
inspect tftp
```

Adding a Policy Map

To create a policy map, perform the following steps:

-
- Step 1** Add the policy map by entering the following command:
- ```
hostname(config)# policy-map policy_map_name
```
- Step 2** (Optional) Specify a description for the policy map:
- ```
hostname(config-pmap)# description text
```
- Step 3** Specify a previously configured class maps using the following command:
- ```
hostname(config-pmap)# class class_map_name
```

See the “[Identifying Traffic Using a Class Map](#)” section on page 18-2 to add a class map.

- Step 4** Specify one or more actions for this class map.
- IPS. See the “[Configuring the AIP SSM](#)” section on page 19-1.
  - TCP normalization. See the “[Configuring TCP Normalization](#)” section on page 19-4.
  - Connection limits. See the “[Configuring Connection Limits and Timeouts](#)” section on page 19-9.
  - QoS policing and QoS priority. See [Chapter 20, “Applying QoS Policies.”](#)
  - Application inspection. See [Chapter 21, “Applying Application Layer Protocol Inspection.”](#)



---

**Note** If there is no **match default\_inspection\_traffic** command in a class map, then at most one **inspect** command is allowed to be configured under the class.

---

**Step 5** Repeat [Step 4](#) for each class map you want to include in this policy map.

The following is an example of a **policy-map** command for connection policy. It limits the number of connections allowed to the web server 10.1.1.1:

```
hostname(config)# access-list http-server permit tcp any host 10.1.1.1
hostname(config)# class-map http-server
hostname(config-cmap)# match access-list http-server

hostname(config)# policy-map global-policy
hostname(config-pmap)# description This policy map defines a policy concerning connection
to http server.
hostname(config-pmap)# class http-server
hostname(config-pmap-c)# set connection conn-max 256
```

The following example shows how multi-match works in a policy map:

```
hostname(config)# class-map inspection_default
hostname(config-cmap)# match default-inspection-traffic
hostname(config)# class-map http_traffic
hostname(config-cmap)# match port tcp eq 80

hostname(config)# policy-map outside_policy
hostname(config-pmap)# class inspection_default
hostname(config-pmap-c)# inspect http http_map
hostname(config-pmap-c)# inspect sip
hostname(config-pmap)# class http_traffic
hostname(config-pmap-c)# set connection timeout tcp 0:10:0
```

The following example shows how traffic matches the first available class map, and will not match any subsequent class maps that specify actions in the same feature domain:

```
hostname(config)# class-map telnet_traffic
hostname(config-cmap)# match port tcp eq 23
hostname(config)# class-map ftp_traffic
hostname(config-cmap)# match port tcp eq 21
hostname(config)# class-map tcp_traffic
hostname(config-cmap)# match port tcp range 1 65535
hostname(config)# class-map udp_traffic
hostname(config-cmap)# match port udp range 0 65535
hostname(config)# policy-map global_policy
hostname(config-pmap)# class telnet_traffic
hostname(config-pmap-c)# set connection timeout tcp 0:0:0
hostname(config-pmap-c)# set connection conn-max 100
hostname(config-pmap)# class ftp_traffic
hostname(config-pmap-c)# set connection timeout tcp 0:5:0
hostname(config-pmap-c)# set connection conn-max 50
hostname(config-pmap)# class tcp_traffic
hostname(config-pmap-c)# set connection timeout tcp 2:0:0
hostname(config-pmap-c)# set connection conn-max 2000
```

When a Telnet connection is initiated, it matches **class telnet\_traffic**. Similarly, if an FTP connection is initiated, it matches **class ftp\_traffic**. For any TCP connection other than Telnet and FTP, it will match **class tcp\_traffic**. Even though a Telnet or FTP connection can match **class tcp\_traffic**, the security appliance does not make this match because they previously matched other classes.

## Applying a Policy to an Interface Using a Service Policy

To activate the policy map, create a service policy that applies it to one or more interfaces or that applies it globally to all interfaces. Interface service policies take precedence over the global service policy.

To create a service policy by associating a policy map with an interface, enter the following command:

```
hostname(config)# service-policy policy_map_name interface interface_name
```

- To create a service policy that applies to all interfaces that do not have a specific policy, enter the following command:

```
hostname(config)# service-policy policy_map_name global
```

By default, the configuration includes a global policy that matches all default application inspection traffic and applies inspection to the traffic globally. You can only apply one global policy, so if you want to alter the global policy, you need to either edit the default policy or disable it and apply a new one.

The default service policy includes the following command:

```
service-policy global_policy global
```

For example, the following command enables the `inbound_policy` policy map on the outside interface:

```
hostname(config)# service-policy inbound_policy interface outside
```

The following commands disable the default global policy, and enables a new one called `new_global_policy` on all other security appliance interfaces:

```
hostname(config)# no service-policy global_policy global
hostname(config)# service-policy new_global_policy global
```

## Modular Policy Framework Examples

This section includes several Modular Policy Framework examples, and includes the following topics:

- [Applying Inspection and QoS Policing to HTTP Traffic, page 18-9](#)
- [Applying Inspection to HTTP Traffic Globally, page 18-9](#)
- [Applying Inspection and Connection Limits to HTTP Traffic to Specific Servers, page 18-10](#)
- [Applying Inspection to HTTP Traffic with NAT, page 18-11](#)



## Applying Inspection and QoS Policing to HTTP Traffic

In this example (see [Figure 18-1](#)), any HTTP connection (TCP traffic on port 80) that enters or exits the security appliance through the outside interface is classified for HTTP inspection. Any HTTP traffic that exits the outside interface is classified for policing.

**Figure 18-1 HTTP Inspection and QoS Policing**

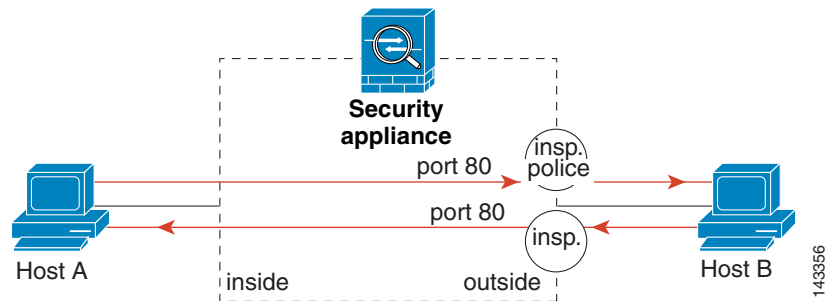

See the following commands for this example:

```
hostname(config)# class-map http_traffic
hostname(config-cmap)# match port tcp eq 80

hostname(config)# policy-map http_traffic_policy
hostname(config-pmap)# class http_traffic
hostname(config-pmap-c)# inspect http
hostname(config-pmap-c)# police 250000
hostname(config)# service-policy http_traffic_policy interface outside
```

## Applying Inspection to HTTP Traffic Globally

In this example (see [Figure 18-2](#)), any HTTP connection (TCP traffic on port 80) that enters the security appliance through any interface is classified for HTTP inspection. Because the policy is a global policy, inspection occurs only as the traffic enters each interface.

**Figure 18-2 Global HTTP Inspection**

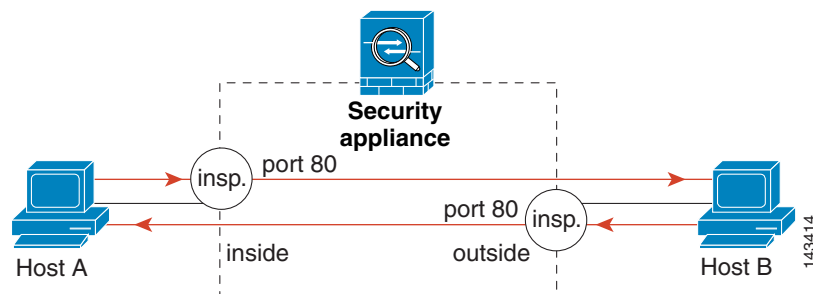

See the following commands for this example:

```
hostname(config)# class-map http_traffic
hostname(config-cmap)# match port tcp eq 80
```

```
hostname(config)# policy-map http_traffic_policy
hostname(config-pmap)# class http_traffic
hostname(config-pmap-c)# inspect http
hostname(config)# service-policy http_traffic_policy global
```

## Applying Inspection and Connection Limits to HTTP Traffic to Specific Servers

In this example (see Figure 18-3), any HTTP connection destined for Server A (TCP traffic on port 80) that enters the security appliance through the outside interface is classified for HTTP inspection and maximum connection limits. Connections initiated from server A to Host A does not match the access list in the class map, so it is not affected.

Any HTTP connection destined for Server B that enters the security appliance through the inside interface is classified for HTTP inspection. Connections initiated from server B to Host B does not match the access list in the class map, so it is not affected.

**Figure 18-3 HTTP Inspection and Connection Limits to Specific Servers**

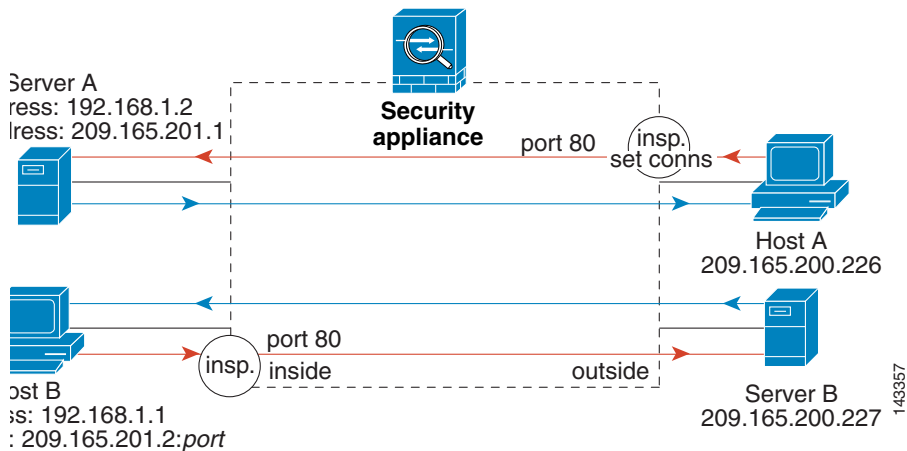

See the following commands for this example:

```
hostname(config)# access-list serverA extended permit tcp any host 192.168.1.1 eq 80
hostname(config)# access-list ServerB extended permit tcp any host 10.1.1.2 eq 80
```

```
hostname(config)# class-map http_serverA
hostname(config-cmap)# match access-list serverA
hostname(config)# class-map http_serverB
hostname(config-cmap)# match access-list serverB
```

```
hostname(config)# policy-map policy_serverA
hostname(config-pmap)# class http_serverA
hostname(config-pmap-c)# inspect http http_map_serverA
hostname(config-pmap-c)# set connection conn-max 100
hostname(config)# policy-map policy_serverB
hostname(config-pmap)# class http_serverB
hostname(config-pmap-c)# inspect http http_map_serverB
```

```
hostname(config)# service-policy policy_serverB interface inside
hostname(config)# service-policy policy_serverA interface outside
```

## Applying Inspection to HTTP Traffic with NAT

In this example, the Host on the inside network has two addresses: one is the real IP address 192.168.1.1, and the other is a mapped IP address used on the outside network, 209.165.200.225. Because the policy is applied to the inside interface, where the real address is used, then you must use the real IP address in the access list in the class map. If you applied it to the outside interface, you would use the mapped address.

**Figure 18-4 HTTP Inspection with NAT**

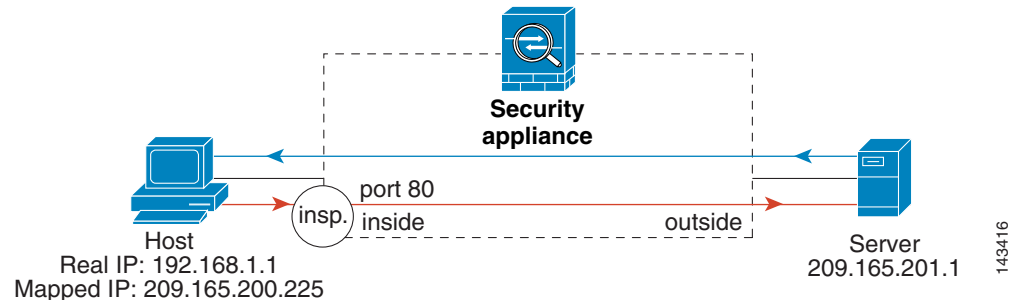

See the following commands for this example:

```
hostname(config)# static (inside,outside) 209.165.200.225 192.168.1.1
hostname(config)# access-list http_client extended permit tcp host 192.168.1.1 any eq 80

hostname(config)# class-map http_client
hostname(config-cmap)# match access-list http_client

hostname(config)# policy-map http_client
hostname(config-pmap)# class http_client
hostname(config-pmap-c)# inspect http

hostname(config)# service-policy http_client interface inside
```





# Intercepting and Responding to Network Attacks

This chapter describes how to configure protection features to intercept and respond to network attacks. These features include sending traffic to an AIP SSM, limiting TCP and UDP connections, configuring TCP normalization, and many other protection features.

This chapter includes the following sections:

- [Configuring the AIP SSM, page 19-1](#)
- [Configuring IP Audit for Basic IPS Support, page 19-4](#)
- [Configuring TCP Normalization, page 19-4](#)
- [Protecting Your Network Against Specific Attacks, page 19-7](#)

## Configuring the AIP SSM

The ASA 5500 series adaptive security appliance supports the AIP SSM, which runs advanced IPS software that provides further security inspection either in inline mode or promiscuous mode (see the following procedure for more information about these modes). The security appliance diverts packets to the AIP SSM just before the packet exits the egress interface (or before VPN encryption occurs, if configured) and after other firewall policies are applied. For example, packets that are blocked by an access list are not forwarded to the AIP SSM.



### Note

The AIP SSM is not supported in Cisco PIX 500 series security appliances.

Configuring the AIP SSM is a two-part process that involves configuration of the ASA 5500 series adaptive security appliance first, and then configuration of the AIP SSM:

1. On the ASA 5500 series adaptive security appliance, identify traffic to divert to the AIP SSM (as described in the [“Configuring the ASA 5500 to Divert Traffic to the AIP SSM”](#) section on [page 19-2](#)).
2. On the AIP SSM, configure the inspection and protection policy, which determines how to inspect traffic and what to do when an intrusion is detected. Because the IPS software that runs on the AIP SSM is very robust and beyond the scope of this document, detailed configuration information is available in the following separate documentation:
  - [Configuring the Cisco Intrusion Prevention System Sensor Using the Command Line Interface](#)
  - [Cisco Intrusion Prevention System Command Reference](#)

## Configuring the ASA 5500 to Divert Traffic to the AIP SSM

To identify traffic to divert from the security appliance to the AIP SSM, perform the following steps:

**Step 1** To identify the traffic, add a class map using the **class-map** command according to [Chapter 18, “Using Modular Policy Framework.”](#)

**Step 2** To add or edit a policy map that sets the actions to take with the class map traffic, enter the following command:

```
hostname(config)# policy-map name
```

**Step 3** To identify the class map from [Step 1](#) to which you want to assign an action, enter the following command:

```
hostname(config-pmap)# class class_map_name
```

**Step 4** To assign traffic to the AIP SSM, enter the following command:

```
hostname(config-pmap-c)# ips {inline | promiscuous} {fail-close | fail-open}
```

Where the **inline** keyword places the AIP SSM directly in the traffic flow. No traffic can continue through the security appliance without first passing through, and being inspected by, the AIP SSM. This mode is the most secure because every packet is analyzed before being allowed through. Also, the AIP SSM can implement a blocking policy on a packet-by-packet basis. This mode, however, can affect throughput.

The **promiscuous** keyword sends a duplicate stream of traffic to the AIP SSM. This mode is less secure, but has little impact on traffic throughput. Unlike inline mode, the SSM can only block traffic by instructing the security appliance to **shun** the traffic or by resetting a connection on the security appliance. Moreover, while the AIP SSM is analyzing the traffic, a small amount of traffic might pass through the security appliance before the AIP SSM can block it.

The **fail-close** keyword sets the security appliance to block all traffic if the AIP SSM is unavailable.

The **fail-open** keyword sets the security appliance to allow all traffic through, uninspected, if the AIP SSM is unavailable.

**Step 5** To activate the policy map on one or more interfaces, enter the following command:

```
hostname(config)# service-policy policymap_name {global | interface interface_name}
```

Where **global** applies the policy map to all interfaces, and **interface** applies the policy to one interface. Only one global policy is allowed. You can override the global policy on an interface by applying a service policy to that interface. You can only apply one policy map to each interface.

The following example diverts all IP traffic to the AIP SSM in promiscuous mode, and blocks all IP traffic should the AIP SSM card fail for any reason:

```
hostname(config)# access-list IPS permit ip any any
hostname(config)# class-map my-ips-class
hostname(config-cmap)# match access-list IPS
hostname(config-cmap)# policy-map my-ips-policy
hostname(config-pmap)# class my-ips-class
hostname(config-pmap-c)# ips promiscuous fail-close
hostname(config-pmap-c)# service-policy my-ips-policy global
```

## Sessioning to the AIP SSM and Running Setup

After you have completed configuration of the ASA 5500 series adaptive security appliance to divert traffic to the AIP SSM, session to the AIP SSM and run the setup utility for initial configuration.



**Note** You can either session to the SSM from the adaptive security appliance (by using the **session 1** command) or you can connect directly to the SSM using SSH or Telnet on its management interface. Alternatively, you can use ASDM.

To session to the AIP SSM from the adaptive security appliance, perform the following steps:

**Step 1** Enter the **session 1** command to session from the ASA 5500 series adaptive security appliance to the AIP SSM.

```
hostname# session 1
Opening command session with slot 1.
Connected to slot 1. Escape character sequence is 'CTRL-^X'.
```

**Step 2** Enter the username and password. The default username and password are both **cisco**.



**Note** The first time you log in to the AIP SSM you are prompted to change the default password. Passwords must be at least eight characters long and *not* a dictionary word.

```
login: cisco
Password:
Last login: Fri Sep 2 06:21:20 from xxx.xxx.xxx.xxx
NOTICE
This product contains cryptographic features and is subject to United States
and local country laws governing import, export, transfer and use. Delivery
of Cisco cryptographic products does not imply third-party authority to import,
export, distribute or use encryption. Importers, exporters, distributors and
users are responsible for compliance with U.S. and local country laws. By using
this product you agree to comply with applicable laws and regulations. If you
are unable to comply with U.S. and local laws, return this product immediately.

A summary of U.S. laws governing Cisco cryptographic products may be found at:
http://www.cisco.com/wvl/export/crypto/tool/stqrg.html

If you require further assistance please contact us by sending email to
export@cisco.com.

LICENSE NOTICE
There is no license key installed on the system.
Please go to http://www.cisco.com/go/license
to obtain a new license or install a license.
AIP SSM#
```



**Note** If you see the license notice above (which displays only in some versions of software), you can ignore the message until you need to upgrade the signature files on the AIP SSM. The AIP SSM continues to operate at the current signature level until a valid license key is installed. You can install the license key at a later time. The license key does not affect the current functionality of the AIP SSM.

**Step 3** Enter the **setup** command to run the setup utility for initial configuration of the AIP SSM.

```
AIP SSM# setup
```

You are now ready to configure the AIP SSM for intrusion prevention. Refer to the following two guides for AIP SSM configuration information:

- [Configuring the Cisco Intrusion Prevention System Sensor Using the Command Line Interface](#)
- [Cisco Intrusion Prevention System Command Reference](#)

## Configuring IP Audit for Basic IPS Support

The IP audit feature provides basic IPS support for a security appliance that does not have an AIP SSM. It supports a basic list of signatures, and you can configure the security appliance to perform one or more actions on traffic that matches a signature.

To enable IP audit, perform the following steps:

---

**Step 1** To define an IP audit policy for informational signatures, enter the following command:

```
hostname(config)# ip audit name name info [action [alarm] [drop] [reset]]
```

Where **alarm** generates a system message showing that a packet matched a signature, **drop** drops the packet, and **reset** drops the packet and closes the connection. If you do not define an action, then the default action is to generate an alarm.

**Step 2** To define an IP audit policy for attack signatures, enter the following command:

```
hostname(config)# ip audit name name attack [action [alarm] [drop] [reset]]
```

Where **alarm** generates a system message showing that a packet matched a signature, **drop** drops the packet, and **reset** drops the packet and closes the connection. If you do not define an action, then the default action is to generate an alarm.

**Step 3** To assign the policy to an interface, enter the following command:

```
ip audit interface interface_name policy_name
```

**Step 4** To disable signatures, or for more information about signatures, see the **ip audit signature** command in the *Cisco Security Appliance Command Reference*.

---

## Configuring TCP Normalization

The TCP normalization feature lets you specify criteria that identify abnormal packets, which the security appliance drops when they are detected. This feature uses Modular Policy Framework, so that implementing TCP normalization consists of identifying traffic, specifying the TCP normalization criteria, and activating TCP normalization on an interface. See [Chapter 18, “Using Modular Policy Framework,”](#) for more information.

To configure TCP normalization, perform the following steps:

---

**Step 1** To specify the TCP normalization criteria that you want to look for, create a TCP map by entering the following command:



```
hostname(config)# tcp-map tcp-map-name
```

For each TCP map, you can specify one or more settings.

**Step 2** Configure the TCP map criteria by entering commands for one or more of the following options:

- Prevent inconsistent TCP retransmissions:

```
hostname(config-tcp-map)# check-retransmission
```

- Verify the checksum:

```
hostname(config-tcp-map)# checksum-verification
```

- Allow packets whose data length exceeds the TCP maximum segment size. The default is to drop these packets, so use this command to allow them.

```
hostname(config-tcp-map)# exceed-mss {allow | drop}
```

- Set the maximum number of out-of-order packets that can be queued for a TCP connection:

```
hostname(config-tcp-map)# queue-limit pkt_num
```

Where *pkt\_num* specifies the maximum number of out-of-order packets. The range is 0 to 250 and the default is 0.

- Clear reserved bits in the TCP header, or drop packets with reserved bits set. The default is to allow reserved bits, so use this command to clear them or drop the packets.

```
hostname(config-tcp-map)# reserved-bits {allow | clear | drop}
```

Where **allow** allows packets with the reserved bits in the TCP header. **clear** clears the reserved bits in the TCP header and allows the packet. **drop** drops the packet with the reserved bits in the TCP header.

- Drop SYN packets with data. The default is to allow SYN packets with data, so use this command to drop the packets.

```
hostname(config-tcp-map)# syn-data {allow | drop}
```

- Clears the selective-ack, timestamps, or window-scale TCP options, or drops a range of TCP options by number. The default is to allow packets with specified options, or to clear the options within the range, so use this command to clear, allow, or drop them.

```
hostname(config-tcp-map)# tcp-options {selective-ack | timestamp | window-scale}
{allow | clear}
```

Or:

```
hostname(config-tcp-map)# tcp-options range lower upper {allow | clear | drop}
```

Where **allow** allows packets with the specified option. **clear** clears the option and allows the packet. **drop** drops the packet.

The **selective-ack** keyword allows or clears the SACK option. The default is to allow the SACK option.

The **timestamp** keyword allows or clears the timestamp option. Clearing the timestamp option disables PAWS and RTT. The default is to allow the timestamp option.

The **window-scale** keyword allows or clears the window scale mechanism option. The default is to allow the window scale mechanism option.

The **range** keyword specifies a range of options.

The *lower* argument sets the lower end of the range as 6, 7, or 9 through 255.

The *upper* argument sets the upper end of the range as 6, 7, or 9 through 255.

- Disable the TTL evasion protection:

```
hostname(config-tcp-map)# ttl-evasion-protection
```

Do not enter this command if you want to prevent attacks that attempt to evade security policy.

For example, an attacker can send a packet that passes policy with a very short TTL. When the TTL goes to zero, a router between the security appliance and the endpoint drops the packet. It is at this point that the attacker can send a malicious packet with a long TTL that appears to the security appliance to be a retransmission and is passed. To the endpoint host, however, it is the first packet that has been received by the attacker. In this case, an attacker is able to succeed without security preventing the attack.

- Allow the URG pointer:

```
hostname(config-tcp-map)# urgent-flag {allow | clear}
```

The URG flag is used to indicate that the packet contains information that is of higher priority than other data within the stream. The TCP RFC is vague about the exact interpretation of the URG flag, therefore end systems handle urgent offsets in different ways, which may make the end system vulnerable to attacks. The default behavior is to clear the URG flag and offset. Use this command to allow the URB flag.

- Drop a connection that has changed its window size unexpectedly. The default is to allow connections, so use this command to drop them.

```
hostname(config-tcp-map)# window-variation {allow | drop}
```

The window size mechanism allows TCP to advertise a large window and to subsequently advertise a much smaller window without having accepted too much data. From the TCP specification, “shrinking the window” is strongly discouraged. When this condition is detected, the connection can be dropped.

- Configure the maximum number of out-of-order packets that can be queued for a TCP connection:

```
hostname(config-tcp-map)# queue-limit packets
```

The number of packets is from 0 to 250.

**Step 3** To identify the traffic to which you want to apply TCP normalization, add a class map using the **class-map** command. See the “[Identifying Traffic Using a Class Map](#)” section on page 18-2 for more information.

**Step 4** To add or edit a policy map that sets the actions to take with the class map traffic, enter the following command:

```
hostname(config)# policy-map name
```

**Step 5** To identify the class map from Step 1 to which you want to assign an action, enter the following command:

```
hostname(config-pmap)# class class_map_name
```

**Step 6** Apply the TCP map to the class map by entering the following command.

```
hostname(config-pmap-c)# set connection advanced-options tcp-map-name
```

**Step 7** To activate the policy map on one or more interfaces, enter the following command:

```
hostname(config)# service-policy polycmap_name {global | interface interface_name}
```

Where **global** applies the policy map to all interfaces, and **interface** applies the policy to one interface. Only one global policy is allowed. You can override the global policy on an interface by applying a service policy to that interface. You can only apply one policy map to each interface.

For example, to allow urgent flag and urgent offset packets for all traffic sent to the range of TCP ports between the well known FTP data port and the Telnet port, enter the following commands:

```
hostname(config)# tcp-map tmap
hostname(config-tcp-map)# urgent-flag allow
hostname(config-tcp-map)# class-map urg-class
hostname(config-cmap)# match port tcp range ftp-data telnet
hostname(config-cmap)# policy-map pmap
hostname(config-pmap)# class urg-class
hostname(config-pmap-c)# set connection advanced-options tmap
hostname(config-pmap-c)# service-policy pmap global
```

## Protecting Your Network Against Specific Attacks

This section describes how to configure protection from certain attacks. This section includes the following topics:

- [Preventing IP Spoofing, page 19-7](#)
- [Configuring Connection Limits and Timeouts, page 19-9](#)
- [Configuring the Fragment Size, page 19-10](#)
- [Blocking Unwanted Connections, page 19-10](#)

### Preventing IP Spoofing

This section lets you enable Unicast Reverse Path Forwarding on an interface. Unicast RPF guards against IP spoofing (a packet uses an incorrect source IP address to obscure its true source) by ensuring that all packets have a source IP address that matches the correct source interface according to the routing table.

Normally, the security appliance only looks at the destination address when determining where to forward the packet. Unicast RPF instructs the security appliance to also look at the source address; this is why it is called Reverse Path Forwarding. For any traffic that you want to allow through the security appliance, the security appliance routing table must include a route back to the source address. See RFC 2267 for more information.

For outside traffic, for example, the security appliance can use the default route to satisfy the Unicast RPF protection. If traffic enters from an outside interface, and the source address is not known to the routing table, the security appliance uses the default route to correctly identify the outside interface as the source interface.

If traffic enters the outside interface from an address that is known to the routing table, but is associated with the inside interface, then the security appliance drops the packet. Similarly, if traffic enters the inside interface from an unknown source address, the security appliance drops the packet because the matching route (the default route) indicates the outside interface.

Unicast RPF is implemented as follows:

- ICMP packets have no session, so each packet is checked.

- UDP and TCP have sessions, so the initial packet requires a reverse route lookup. Subsequent packets arriving during the session are checked using an existing state maintained as part of the session. Non-initial packets are checked to ensure they arrived on the same interface used by the initial packet.

To enable Unicast RPF, enter the following command:

```
hostname(config)# ip verify reverse-path interface interface_name
```

## Configuring Connection Limits and Timeouts

This section describes how to set maximum TCP and UDP connections, maximum embryonic connections, connection timeouts, and how to disable TCP sequence randomization.

Limiting the number of connections and embryonic connections protects you from a DoS attack. The security appliance uses the embryonic limit to trigger TCP Intercept, which protects inside systems from a DoS attack perpetrated by flooding an interface with TCP SYN packets. An embryonic connection is a connection request that has not finished the necessary handshake between source and destination.

Each TCP connection has two ISNs: one generated by the client and one generated by the server. The security appliance randomizes the ISN of the TCP SYN passing in both the inbound and outbound directions.

Randomizing the ISN of the protected host prevents an attacker from predicting the next ISN for a new connection and potentially hijacking the new session.

TCP initial sequence number randomization can be disabled if required. For example:

- If another in-line firewall is also randomizing the initial sequence numbers, there is no need for both firewalls to be performing this action, even though this action does not affect the traffic.
- If you use eBGP multi-hop through the security appliance, and the eBGP peers are using MD5. Randomization breaks the MD5 checksum.
- You use a WAAS device that requires the security appliance not to randomize the sequence numbers of connections.



### Note

You can also configure maximum connections, maximum embryonic connections, and TCP sequence randomization in the NAT configuration. If you configure these settings for the same traffic using both methods, then the security appliance uses the lower limit. For TCP sequence randomization, if it is disabled using either method, then the security appliance disables TCP sequence randomization.

To set connection limits, perform the following steps:

- 
- Step 1** To identify the traffic, add a class map using the **class-map** command according to [Chapter 18, “Using Modular Policy Framework.”](#)
- Step 2** To add or edit a policy map that sets the actions to take with the class map traffic, enter the following command:
- ```
hostname(config)# policy-map name
```
- Step 3** To identify the class map from Step 1 to which you want to assign an action, enter the following command:
- ```
hostname(config-pmap)# class class_map_name
```
- Step 4** To set the maximum connections (both TCP and UDP), maximum embryonic connections, or whether to disable TCP sequence randomization, enter the following command:
- ```
hostname(config-pmap-c)# set connection {[conn-max number] [embryonic-conn-max number]
[random-sequence-number {enable | disable}]}
```

Where *number* is an integer between 0 and 65535. The default is 0, which means no limit on connections.

You can enter this command all on one line (in any order), or you can enter each attribute as a separate command. The command is combined onto one line in the running configuration.

- Step 5** To set the timeout for connections, embryonic connections (half-opened), and half-closed connections, enter the following command:

```
hostname(config-pmap-c)# set connection {[embryonic hh[:mm[:ss]]]
[half-closed hh[:mm[:ss]]] [tcp hh[:mm[:ss]]]}
```

Where **embryonic** *hh[:mm[:ss]]* is a time between 0:0:5 and 1192:59:59. The default is 0:0:30. You can also set this value to 0, which means the connection never times out.

The **half-closed** *hh[:mm[:ss]]* and **tcp** *hh[:mm[:ss]]* values are a time between 0:5:0 and 1192:59:59. The default for **half-closed** is 0:10:0 and the default for **tcp** is 1:0:0. You can also set these values to 0, which means the connection never times out.

You can enter this command all on one line (in any order), or you can enter each attribute as a separate command. The command is combined onto one line in the running configuration.

- Step 6** To activate the policy map on one or more interfaces, enter the following command:

```
hostname(config)# service-policy policymap_name {global | interface interface_name}
```

Where **global** applies the policy map to all interfaces, and **interface** applies the policy to one interface. Only one global policy is allowed. You can override the global policy on an interface by applying a service policy to that interface. You can only apply one policy map to each interface.

Configuring the Fragment Size

By default, the security appliance allows up to 24 fragments per IP packet, and up to 200 fragments awaiting reassembly. You might need to let fragments on your network if you have an application that routinely fragments packets, such as NFS over UDP. However, if you do not have an application that fragments traffic, we recommend that you do not allow fragments through the security appliance. Fragmented packets are often used as DoS attacks. To set disallow fragments, enter the following command:

```
hostname(config)# fragment chain 1 [interface_name]
```

Enter an interface name if you want to prevent fragmentation on a specific interface. By default, this command applies to all interfaces.

Blocking Unwanted Connections

If you know that a host is attempting to attack your network (for example, system log messages show an attack), then you can block (or shun) connections based on the source IP address and other identifying parameters. No new connections can be made until you remove the shun.



Note

If you have an IPS that monitors traffic, such as the AIP SSM, then the IPS can shun connections automatically.

To shun a connection manually, perform the following steps:

- Step 1** If necessary, view information about the connection by entering the following command:

```
hostname# show conn
```

The security appliance shows information about each connection, such as the following:

```
TCP out 64.101.68.161:4300 in 10.86.194.60:23 idle 0:00:00 bytes 1297 flags UIO
```

Step 2 To shun connections from the source IP address, enter the following command:

```
hostname(config)# shun src_ip [dst_ip src_port dest_port [protocol]] [vlan vlan_id]
```

If you enter only the source IP address, then all future connections are shunned; existing connections remain active.

To drop an existing connection, as well as blocking future connections from the source IP address, enter the destination IP address, source and destination ports, and the protocol. By default, the protocol is 0 for IP.

For multiple context mode, you can enter this command in the admin context, and by specifying a VLAN ID that is assigned to a subinterface in other contexts, you can shun the connection in other contexts.

Step 3 To remove the shun, enter the following command:

```
hostname(config)# no shun src_ip [vlan vlan_id]
```



Applying QoS Policies

This chapter describes how to apply QoS policies, and contains the following sections:

- [Overview, page 20-1](#)
- [QoS Concepts, page 20-2](#)
- [Implementing QoS, page 20-2](#)
- [Identifying Traffic for QoS, page 20-4](#)
- [Defining a QoS Policy Map, page 20-5](#)
- [Applying Rate Limiting, page 20-6](#)
- [Activating the Service Policy, page 20-7](#)
- [Applying Low Latency Queueing, page 20-8](#)
- [Configuring QoS, page 20-9](#)
- [Viewing QoS Configuration, page 20-12](#)
- [Viewing QoS Statistics, page 20-13](#)

Overview

Have you ever participated in a long-distance phone call that involved a satellite connection? The conversation may be interrupted with brief, but perceptible, gaps at odd intervals. Those gaps are the time, called the *latency*, between the arrival of packets being transmitted over the network. Some network traffic, such as voice and streaming video, cannot tolerate long latency times. *Quality of Service (QoS)* is a network feature that lets you give priority to these types of traffic.

As the Internet community of users upgrades their access points from modems to high-speed broadband connections like DSL and cable, the likelihood increases that at any given time, a single user might be able to absorb most, if not all, of the available bandwidth, thus starving the other users. To prevent any one user or site-to-site connection from consuming more than its fair share of bandwidth, QoS provides a policing feature that regulates the maximum bandwidth that any user can use.

QoS refers to the capability of a network to provide better service to selected network traffic over various technologies for the best overall services with limited bandwidth of the underlying technologies.

The primary goal of QoS in the security appliance is to provide rate limiting on selected network traffic for both individual flow or VPN tunnel flow to ensure that all traffic gets its fair share of limited bandwidth. A flow can be defined in a number of ways. In the security appliance, QoS can apply to a combination of source and destination IP addresses, source and destination port number, and the TOS byte of the IP header.

QoS Concepts

QoS is a traffic-management strategy that lets you allocate network resources for both mission-critical and normal data, based on the type of network traffic and the priority you assign to that traffic. In short, QoS ensures unimpeded priority traffic and provides the capability of rate-limiting (policing) default traffic.

For example, video and voice over IP (VoIP) are increasingly important for interoffice communication between geographically dispersed sites, using the infrastructure of the Internet as the transport mechanism. Firewalls are key to securing networks by controlling access, which includes inspecting VoIP protocols. QoS is the focal point to provide clear, uninterrupted voice and video communications, while still providing a basic level of service for all other traffic passing through the device.

For voice and video to traverse IP networks in a secure, reliable, and toll-quality manner, QoS must be enabled at all points of the network. Implementing QoS lets you:

- **Simplify network operations** by collapsing all data, voice, and video network traffic onto a single backbone using similar technologies.
- **Enable new network applications**, such as integrated call center applications and video-based training, that can help differentiate enterprises in their respective market spaces and increase productivity.
- **Control resource use** by controlling which traffic receives which resources. For example, you can ensure that the most important, time-critical traffic receives the network resources (available bandwidth and minimum delay) it needs, and that other applications using the link get their fair share of service without interfering with mission-critical traffic.

QoS provides maximum rate control, or policing, for tunneled traffic for each individual user tunnel and every site-to-site tunnel. In this release, there is no minimum bandwidth guarantee.

The security appliance can police individual user traffic within a LAN-to-LAN tunnel by configuring class-maps that are not associated with the tunnel, but whose traffic eventually passes through the LAN-to-LAN tunnel. The traffic before the LAN-to-LAN tunnel can then be specifically policed as it passes through the tunnel and is policed again to the aggregate rate applied to the tunnel.

The security appliance achieves QoS by allowing two types of traffic queues for each interface: a low-latency queue (LLQ) and a default queue. Only the default traffic is subject to rate limiting.

QoS is disabled by default.

**Note**

You must consider that in an ever-changing network environment, QoS is not a one-time deployment, but an ongoing, essential part of network design.

Implementing QoS

In general, provisioning QoS policies requires the following steps:

1. Specifying traffic classes.
2. Associating actions with each traffic class to formulate policies.
3. Activating the policies.

The specification of a classification policy—that is, the definition of traffic classes—is separate from the specification of the policies that act on the results of the classification.

A *traffic class* is a set of traffic that is identifiable by its packet content. For example, TCP traffic with a port value of 23 might be classified as a Telnet traffic class.

An *action* is a specific activity taken to protect information or resources, in this case to perform QoS functions. An action is typically associated with a specific traffic class.

Configuring a traditional QoS policy for the security appliance consists of the following steps:

- Defining traffic classes (**class-map** command).
- Associating policies and actions with each class of traffic (**policy-map** command).
- Attaching policies to logical or physical interfaces (**service-policy** command).

**Note**

For detailed configuration steps, see the “[Configuring QoS](#)” section on page 20-9.

The **class-map** command defines a named object representing a class of traffic, specifying the packet matching criteria that identifies packets that belong to this class. The basic form of the command is:

```
class-map class-map-name-1
  match match-criteria-1
class-map class-map-name-n
  match match-criteria-n
```

The **policy-map** command defines a named object that represents a set of policies to be applied to a set of traffic classes. An example of such a policy is policing the traffic class to some maximum rate. The basic form of the command is:

```
policy-map policy-map-name
  class class-map-name-1
    policy-1
    policy-n
  class class-map-name-n
    policy-m
    policy-m+1
```

The **service-policy** command attaches a policy-map and its associated policies to a target, named interface.

**Note**

QoS-related policies under policy-map-name apply only to the outbound traffic, not to the inbound traffic of the named interface.

The command also indicates whether the policies apply to packets coming from or sent to the target. For example, an output policy (applied to packets exiting an interface) is applied as follows:

```
hostname(config)# service-policy policy-map-name interface outside
```

In addition, if you are differentiating between priority traffic and best-effort traffic, you must define a low-latency queue (**priority-queue** command) on each named, physical interface transmitting prioritized traffic.

The following example enables a default priority-queue with the default queue-limit and tx-ring-limit:

```
priority-queue name-interface
```

The following sections explain each of these uses in more detail.

Identifying Traffic for QoS

The **class-map** command classifies a set of traffic with which QoS actions are associated. You can use various types of match criteria to classify traffic. The **match** commands identify the traffic included in the traffic class for a class map. They include different criteria to define the traffic included in a class-map. Define a traffic class using the **class-map** global configuration command as part of configuring a security feature using Modular Policy Framework. From class-map configuration mode, you can define the traffic to include in the class using the **match** command.

After a traffic class is applied to an interface, packets received on that interface are compared to the criteria defined by the **match** statements in the class map. If the packet matches the specified criteria, it is included in the traffic class and is subjected to any actions associated with that traffic class. Packets that do not match any of the criteria in any traffic class are assigned to the default traffic class.

One such criterion is access-list. For example, in the following sequence, the **class-map** command classifies all non-tunneled TCP traffic, using an access-list named `tcp_traffic`:

```
hostname(config)# access-list tcp_traffic permit tcp any any
hostname(config)# class-map tcp_traffic
hostname(config-cmap)# match access-list tcp_traffic
```

When a packet is matched against a class-map, the result is either a match or a no-match.

In the following example, other, more specific match criteria are used for classifying traffic for specific, security-related tunnel groups. These specific match criteria stipulate that a match on tunnel-group (in this case, the previously-defined Tunnel-Group-1) is required as the first match characteristic to classify traffic for a specific tunnel, and it allows for an additional match line to classify the traffic (IP differential services code point, expedited forwarding).

```
hostname(config)# class-map TG1-voice
hostname(config-cmap)# match tunnel-group Tunnel-Group-1
hostname(config-cmap)# match dscp ef
```

In the following example, the **class-map** command classifies both tunneled and non-tunneled traffic according to the traffic type:

```
hostname(config)# access-list tunneled extended permit ip 10.10.34.0 255.255.255.0 20.20.10.0 255.255.255.0
hostname(config)# access-list non-tunneled extended permit tcp any any
hostname(config)# tunnel-group tunnel-grp1 type IPSec_L2L

hostname(config)# class-map browse
hostname(config-cmap)# description "This class-map matches all non-tunneled tcp traffic."
hostname(config-cmap)# match access-list non-tunneled

hostname(config-cmap)# class-map TG1-voice
hostname(config-cmap)# description "This class-map matches all dscp ef traffic for tunnel-grp 1."
hostname(config-cmap)# match dscp ef
hostname(config-cmap)# match tunnel-group tunnel-grp1

hostname(config-cmap)# class-map TG1-BestEffort
hostname(config-cmap)# description "This class-map matches all best-effort traffic for tunnel-grp1."
hostname(config-cmap)# match tunnel-group tunnel-grp1
hostname(config-cmap)# match flow ip destination-address
```

The following example shows a way of policing a flow within a tunnel, provided the classed traffic is not specified as a tunnel, but does go *through* the tunnel. In this example, 192.168.10.10 is the address of the host machine on the private side of the remote tunnel, and the access list is named “host-over-I21”. By creating a class-map (named “host-specific”), you can then police the “host-specific” class before the LAN-to-LAN connection polices the tunnel. In this example, the “host-specific” traffic is rate-limited before the tunnel, then the tunnel is rate-limited:

```
hostname(config)# access-list host-over-121 extended permit ip any host 192.168.10.10
hostname(config)# class-map host-specific
hostname(config-cmap)# match access-list host-over-121
```

The following table summarizes the **match** command criteria available and relevant to QoS. For the full list of all match commands and their syntax, see *Cisco Security Appliance Command Reference*:

Command	Description
match access-list	Matches, by name or number, access list traffic within a class map.
match any	Identifies traffic that matches any of the criteria in the class map.
match dscp	Matches the IETF-defined DSCP value (in an IP header) in a class map. You can specify up to 64 different dscp values, defining the class as composed of packets that match any of the specified values.
match flow ip destination-address	Enables flow-based policy actions. The criteria to define flow is the destination IP address. All traffic going to a unique IP destination address is considered a flow. Policy action is applied to each flow instead of the entire class of traffic. This command always accompanies match tunnel group . For remote-access VPNs, this command applies to each remote-access host flow. For LAN-to-LAN VPNs, this command applies to the single aggregated VPN flow identified by the local and remote tunnel address pair.
match port	Specifies the TCP/UDP ports as the comparison criteria for packets received on that interface.
match precedence	Matches the precedence value represented by the TOS byte in the IP header. You can specify up to 8 different precedence values, defining the class as composed of packets that match any of the specified values.
match rtp	Matches traffic that uses a specific RTP port within a specified range. The allowed range is targeted at capturing applications likely to be using RTP. The packet matches the defined class only if the UDP port falls within the specified range, inclusive, and the port number is an even number.
match tunnel group	Matches every tunnel within the specified tunnel group.

In addition to the user-defined classes, a system-defined class named **class-default** also exists. This **class-default** represents all packets that do not match any of the user-defined classes, so that policies can be defined for these packets.

Defining a QoS Policy Map

The **policy-map** command configures various policies, such as security policies or QoS policies. A policy is an association of a traffic class, specified by a **class** command, and one or more actions. This section specifically deals with using the **policy-map** command to define the QoS policies for one or more classes of packets.

When you enter a **policy-map** command you enter the policy-map configuration mode, and the prompt changes to indicate this. In this mode, you can enter **class** and **description** commands. A **policy-map** command can specify multiple policies. The maximum number of policy maps is 64.

After entering the **policy-map** command, you then enter a **class** command to specify the classification of the packet traffic. The **class** command configures QoS policies for the class of traffic specified in the given class-map. A traffic class is a set of traffic that is identifiable by its packet content. For example,

TCP traffic with a port value of 23 can be classified as a Telnet traffic class. The **class** commands are differentiated by their previously named and constructed class-map designations, and the associated actions follow immediately after.

The security appliance evaluates class-maps in the order in which they were entered in the policy-map configuration. It classifies a packet to the first class-map that matches the packet.

**Note**

The order in which different types of actions in a policy-map are performed is independent of the order in which the actions appear in the command descriptions in this document.

The **priority** command provides low-latency queuing for delay-sensitive traffic, such as voice. This command selects all packets that match the associated class (TG1-voice in the previous example) and sends them to the low latency queue for priority processing.

Applying Rate Limiting

Every user's Bandwidth Limiting Traffic stream (BLT) can participate in maximum bandwidth limiting; that is, strict policing, which rate-limits the individual user's default traffic to some maximum rate. This prevents any one individual user's BLTs from overwhelming any other. LLQ traffic, however, is marked and processed downstream in a priority queue. This traffic is not rate-limited.

Policing is a way of ensuring that no traffic exceeds the maximum rate (bits/second) that you configure, thus ensuring that no one traffic flow can take over the entire resource. You use the **police** command to specify the maximum rate (that is, the rate limit for this traffic flow); this is a value in the range 8000-2000000000, specifying the maximum speed (*bits* per second) allowed.

You also specify what action, drop or transmit, to take for traffic that conforms to the limit and for traffic that exceeds the limit.

**Note**

You can specify the drop action, but it is not functional. The action is always to transmit, except when the rate is exceeded, and even then, the action is to throttle the traffic to the maximum allowable speed.

The **police** command also configures the largest single burst of traffic allowed. A burst value in the range 1000-512000000 specifies the maximum number of instantaneous *bytes* allowed in a sustained burst before throttling to the conforming rate value.

**Note**

Policing is applied only in the output direction.

You cannot enable both priority and policing together.

If a service policy is applied or removed from an interface that has existing VPN client/LAN-to-LAN or non-tunneled traffic already established, the QoS policy is not applied or removed from the traffic stream. To apply or remove the QoS policy for such connections, you must clear (that is, drop) the connections and re-establish them.

**Note**

When policing is specified in the default class map, class-default, the police values of class-default are applied to the aggregated LAN-to-LAN VPN flow if there is no police command defined for tunnel-group of LAN-to-LAN VPN. In other words, the policing values of class-default are never applied to the individual flow of a LAN-to-LAN VPN that exists before encryption.

The following example builds on the configuration developed in the previous section. As in the previous example, there are two named class-maps: `tcp_traffic` and `TG1-voice`. Adding a third class-map:

```
hostname(config)# class-map TG1-best-effort
hostname(config-cmap)# match tunnel-group Tunnel-Group-1
hostname(config-cmap)# match flow ip destination-address
```

provides a basis for defining a tunneled and non-tunneled QoS policy, as follows, which creates a simple QoS policy for tunneled and non-tunneled traffic, assigning packets of the class `TG1-voice` to the low latency queue and setting rate limits on the `tcp_traffic` and `TG1-best-effort` traffic flows.

**Note**

“Best effort” does not guarantee reliable packet delivery, in that it does not use a sophisticated acknowledgement system. It does, however, make a “best effort” to deliver packets to the destination.

In this example, the maximum rate for traffic of the `tcp_traffic` class is 56,000 bits/second and a maximum burst size of 10,500 bytes per second. For the `TC1-BestEffort` class, the maximum rate is 200,000 bits/second, with a maximum burst of 37,500 bytes/second. Traffic in the `TC1-voice` class has no policed maximum speed or burst rate because it belongs to a priority class:

```
hostname(config)# policy-map qos
hostname(config-pmap)# class tcp_traffic
hostname(config-pmap-c)# police output 56000 10500

hostname(config-pmap-c)# class TG1-voice
hostname(config-pmap-c)# priority

hostname(config-pmap-c)# class TG1-best-effort
hostname(config-pmap-c)# police output 200000 37500

hostname(config-pmap-c)# class class-default
hostname(config-pmap-c)# police output 1000000 37500
```

**Note**

You can have up to 256 policy-maps, and up to 256 classes in a policy map. The maximum number of classes in all policy maps together is 256. For any class-map, you can have only one **match** statement associated with it, with the exception of a tunnel class. For a tunnel class, an additional **match tunnel-group** statement is allowed.

**Note**

The class **class-default** always exists. It does not need to be declared.

Activating the Service Policy

The **service-policy** command activates a **policy-map** command globally on all interfaces or on a targeted interface. An interface can be a virtual (vlan) interface or a physical interface. Only one global policy-map is allowed. If you specify the keyword **interface** and an interface name, the policy-map applies only to that interface. An interface policy-map inherits rules from the global policy-map. For rules that overlap with the global policy map, the interface policy rules will be applied. Only one interface policy-map can be applied to an interface at any one time.

In general, a **service-policy** command can be applied to any interface that can be defined by the **nameif** command.

Using the policy-map example in the previous section, the following **service-policy** command activates the policy-map “qos,” defined in the previous section, for traffic on the outside interface:

```
hostname(config)# service-policy qos interface outside
```

Applying Low Latency Queueing

The security appliance allows two classes of traffic: low latency queuing (LLQ) for higher priority, latency-sensitive traffic (such as voice and video) and best effort, the default, for all other traffic. These two queues are built into the system. The security appliance recognizes QoS priority traffic and enforces appropriate QoS policies.

Because queues are not of infinite size, they can fill and overflow. When a queue is full, any additional packets cannot get into the queue and are dropped. This is *tail drop*. To avoid having the queue fill up, you can use the **queue-limit** command to increase the queue buffer size.

You can configure the low latency (priority) queue to fine-tune the maximum number of packets allowed into the transmit queue (using the **tx-ring-limit** command) and to size the depth of the priority queue (using the **queue-limit** command). This lets you control the latency and robustness of the priority queuing.



Note

The upper limit of the range of values for the **queue-limit** and **tx-ring-limit** commands is determined dynamically at run time. To view this limit, enter **help** or **?** on the command line. The key determinants are the memory needed to support the queues and the memory available on the device. The range of **queue-limit** values is 0 through 2048 packets. The range of **tx-ring-limit** values is 3 through 128 packets on the PIX platform and 3 to 256 packets on the ASA platform.

Configuring Priority Queuing

You identify high priority traffic by using the **priority** command in Class mode. This command instructs the security appliance to mark as high priority the traffic selected by the class map.

For priority queuing to occur, you must create a priority queue for named, physical interfaces that transmit high priority traffic. To enable a priority queue on an interface, use the **priority-queue** command in global configuration mode. You can apply one **priority-queue** command to each physical interface defined by the **nameif** command. All other traffic is delivered on a best-effort basis.

In general, you can apply a **priority-queue** command to any physical interface that can be defined by the **nameif** command. You cannot apply a **priority-queue** command to a VLAN interface. The **priority-queue** command enters priority-queue mode, as shown by the prompt, which lets you configure the maximum number of packets allowed in the transmit queue and the size of the priority queue.



Note

You cannot enable both priority queuing and policing together. In other words, only packets with normal priority can be policed; packets with high priority are not policed.

Sizing the Priority Queue

The size that you specify for the priority queue affects both the low latency queue and the best-effort queue. The **queue-limit** command specifies a maximum number of packets that can be queued to a priority queue before it drops data. This limit must be in the range of 0 through 2048 packets.

Reducing Queue Latency

The **tx-ring-limit** command lets you configure the maximum number of packets (that is, the depth) allowed to be queued in the Ethernet transmit driver ring at any given time. This allows for fine-tuning the transmit queue to reduce latency and offer better performance through the transmit driver. This limit must be in the range 3 through 128 packets on the PIX platform, with a limit of 256 packets on the ASA platform.

The default queue-limit is the number of average, 256-byte packets that the specified interface can transmit in a 500-ms interval, with an upper limit of 2048 packets. A packet that stays more than 500 ms in a network node might trigger a timeout in the end-to-end application. Such a packet can be discarded in each network node.

The default tx-ring-limit is the number of maximum 1550-byte packets that the specified interface can transmit in a 10-ms interval. This guarantees that the hardware-based transmit ring imposes no more than 10-ms of extra latency for a high-priority packet.

The following example establishes a priority queue on interface “outside” (the GigabitEthernet0/1 interface), with the default queue-limit and tx-ring-limit.

```
hostname(config)# priority-queue outside
```

The following example establishes a priority queue on the interface “outside” (the GigabitEthernet0/1 interface), sets the queue-limit to 2048 packets, and sets the tx-ring-limit to 256:

```
hostname(config)# priority-queue outside
hostname(config-priority-queue)# queue-limit 2048
hostname(config-priority-queue)# tx-ring-limit 256
```



Note

When priority queuing is enabled, the security appliance empties all packets in higher priority queues before transmitting packets in lower priority queues.

Configuring QoS

The following procedure provides steps for configuring a traffic class, a policy map, and a service policy that implement QoS policing (rate limiting) or priority queuing. In addition, for priority queuing, it includes steps for enabling priority queues on interfaces.

The number of traffic classes, policy maps, and service policies needed to implement QoS varies depending upon the requirements of your network. Analyze your network and determine how many traffic classes, policy maps, and service policies needed on the security appliance you are configuring, and then use this procedure as applicable to your QoS deployment.

To configure QoS policing and priority queuing, perform the following steps:

Step 1 If you want to perform priority queuing, you must enable priority queues on interfaces.

For each interface on which you want the security appliance to perform priority queuing, perform the following steps:

- a. Enter the **priority-queue** command:

```
hostname(config)# priority-queue interface
hostname(config-priority-queue)#
```

where *interface* is the name assigned to the physical interface whose priority queue you want to enable. VLAN interfaces do not support priority queuing. The CLI enters the priority-queue configuration mode and the prompt changes accordingly

- b. (Optional) If you want to specify a *non-default* maximum number of priority packets that can be queued, enter the **queue-limit** command, as follows:

```
hostname(config-priority-queue)# queue-limit number-of-packets
```

The default queue size is 2048 packets.

- c. (Optional) If you want specify a *non-default* maximum number of packets allowed into the transmit queue, enter the **tx-ring-limit** command, as follows:

```
hostname(config-priority-queue)# tx-ring-limit number-of-packets
```

The default transmit queue size is 128 packets.

- Step 2** Determine which traffic you want to police or mark for priority queuing. For a detailed discussion of identifying QoS traffic, see the [“Identifying Traffic for QoS”](#) section on page 20-4.

- Step 3** Create a class map or modify an existing class map to identify traffic that you want to police or to identify as priority traffic. Use the **class-map** command to do so, as follows:

```
hostname(config)# class-map class_map_name
hostname(config-cmap)#
```

where *class_map_name* is the name of the traffic class. When you enter the **class-map** command, the CLI enters class map configuration mode.

- Step 4** Identify the traffic you determined in [Step 2](#). To do so, use a **match** command. For a detailed discussion of identifying QoS traffic, see the [“Identifying Traffic for QoS”](#) section on page 20-4.

If you need to identify two or more non-contiguous ports, create an access list with the **access-list extended** command, add an ACE to match each port, and then use the **match access-list** command. The following commands show how to use an access list to identify multiple TCP ports with an access list:

```
hostname(config)# access-list acl-name any any tcp eq port_number_1
hostname(config)# access-list acl-name any any tcp eq port_number_2
hostname(config)# class-map class_map_name
hostname(config-cmap)# match access-list acl-name
```

If you need to identify a single port, use the **match port** command, as follows:

```
hostname(config-cmap)# match port {tcp | udp} port_number
```

where *port_number* is the destination port of traffic that you want to configure the security appliance to police or mark for priority queuing.

If you need to identify a range of contiguous ports, use **match port** command with the **range** keyword, as follows:

```
hostname(config-cmap)# match port {tcp | udp} range begin_port_number end_port_number
```

where *begin_port_number* is the lowest port in the range of ports and *end_port_number* is the highest port.

- Step 5** Create a policy map or modify an existing policy map that you want to use to apply policing or priority queuing to the traffic identified in [Step 3](#). For more information about QoS policy maps, see the [“Defining a QoS Policy Map”](#) section on page 20-5.

Use the **policy-map** command, as follows:

```
hostname(config-cmap)# policy-map policy_map_name
hostname(config-pmap)#
```

where *policy_map_name* is the name of the policy map. The CLI enters the policy map configuration mode and the prompt changes accordingly.

- Step 6** Specify the class map, created in [Step 3](#), that identifies the traffic to be policed or marked for priority queuing. Use the **class** command to do so, as follows:

```
hostname(config-pmap)# class class_map_name
hostname(config-pmap-c)#
```

where *class_map_name* is the name of the class map you created in [Step 3](#). The CLI enters the policy map class configuration mode and the prompt changes accordingly.

- Step 7** Configure the action for the class. You can either mark the traffic class as priority traffic or specify rate limiting for the traffic class. Do one of the following:

- If you want the traffic selected by the class map to be marked as priority traffic, enter the **priority** command.

```
hostname(config-pmap-c)# priority
```



Note Along with enabling priority queuing in [Step 1](#), this command initiates priority queuing for the class map you specified.

For details about priority queuing, see the “[Applying Low Latency Queuing](#)” section on page 20-8 and the **priority** command page in the *Cisco Security Appliance Command Reference*.

- If you want the security appliance to police the traffic selected by the class map, enter the **police** command.

```
hostname(config-pmap-c)# police [output] conform-rate [conform-burst] [conform-action
[drop | transmit] [exceed-action {drop | transmit}]]
```

For details about the use of the **police** command, see the “[Applying Rate Limiting](#)” section on page 20-6 and the **police** command page in the *Cisco Security Appliance Command Reference*.

- Step 8** Use the **service-policy** command to apply the policy map globally or to a specific interface, as follows:

```
hostname(config-pmap-c)# service-policy policy_map_name [global | interface interface_ID]
hostname(config)#
```

where *policy_map_name* is the policy map you configured in [Step 5](#). If you want to apply the policy map to traffic on all the interfaces, use the **global** option. If you want to apply the policy map to traffic on a specific interface, use the **interface** *interface_ID* option, where *interface_ID* is the name assigned to the interface with the **nameif** command.

The security appliance begins policing traffic and marking traffic for priority queuing, as specified.

The following example creates class maps for high priority (voice) and best effort traffic for a previously configured tunnel group, named “tunnel-grp1”. The “qos” policy map includes the **police** command for the best effort and the default traffic classes and the **priority** command for the voice class. The service policy is then applied to the outside interface and the priority queue for the outside interface is enabled.

Example 20-1 Configuring QoS Policing and Priority Queuing

```
hostname(config)# priority-queue outside
hostname(config-priority-queue)# queue-limit 2048
hostname(config-priority-queue)# tx-ring-limit 256
```

```

hostname(config)# class-map TG1-voice
hostname(config-cmap)# description "This class-map matches all dscp ef traffic for tunnel-grp 1"
hostname(config-cmap)# match dscp ef
hostname(config-cmap)# match tunnel-group tunnel-grp1

hostname(config-cmap)# class-map TG1-BestEffort
hostname(config-cmap)# description "This class-map matches all best-effort traffic for tunnel-grp1"
hostname(config-cmap)# match tunnel-group tunnel-grp1
hostname(config-cmap)# match flow ip destination-address

hostname(config-cmap)# policy-map qos
hostname(config-pmap)# class TG1-voice
hostname(config-pmap-c)# priority
hostname(config-pmap-c)# class TG1-best-effort
hostname(config-pmap-c)# police output 200000 37500
hostname(config-pmap-c)# class class-default
hostname(config-pmap-c)# police output 1000000 37500

hostname(config-pmap-c)# service-policy qos interface outside

```

Viewing QoS Configuration

This section contains the following topics:

- [Viewing QoS Policy Map Configuration, page 20-13](#)
- [Viewing the Priority-Queue Configuration for an Interface, page 20-13](#)

Viewing QoS Service Policy Configuration

To view all current service policies, including those that implement QoS policy maps, use the **show service-policy** command in privileged EXEC mode. You can limit the output to policies that include the **police** or **priority** commands by using the **police** or **priority** keywords.



Note

This is the same command you use to view priority and police statistics.

The following example shows the output of **show service-policy** with the **police** keyword:

```

hostname# show service-policy police

Global policy:
  Service-policy: global_fw_policy

Interface outside:
  Service-policy: qos
    Class-map: browse
      police Interface outside:
        cir 56000 bps, bc 10500 bytes
        conformed 10065 packets, 12621510 bytes; actions: transmit
        exceeded 499 packets, 625146 bytes; actions: drop
        conformed 5600 bps, exceed 5016 bps
    Class-map: cmap2
      police Interface outside:
        cir 200000 bps, bc 37500 bytes
        conformed 17179 packets, 20614800 bytes; actions: transmit

```

```
exceeded 617 packets, 770718 bytes; actions: drop
conformed 198785 bps, exceed 2303 bps
```

The following example shows the output of **show service-policy** with the **priority** keyword:

```
hostname# show service-policy priority
Global policy:
  Service-policy: global_fw_policy
Interface outside:
  Service-policy: qos
  Class-map: TG1-voice
  Priority:
    Interface outside: aggregate drop 0, aggregate transmit 9383
```

Viewing QoS Policy Map Configuration

To view all policy maps, including those that include the **police** and **priority** commands, use the following command in privileged EXEC mode:

```
hostname# show running-config policy-map
```

For the foregoing examples, the output of this command would look something like the following:

```
hostname# show running-config policy-map
!
policy-map test
  class class-default
policy-map inbound_policy
  class ftp-port
    inspect ftp strict inbound_ftp
policy-map qos
  class browse
    police 56000 10500
  class TG1-voice
    priority
  class TG1-BestEffort
    police 200000 37500
```

Viewing the Priority-Queue Configuration for an Interface

To display the priority-queue configuration for an interface, enter the **show running-config priority-queue** command in global configuration mode. The following example shows the priority-queue configuration for the interface named “test”:

```
hostname(config)# show running-config priority-queue test
priority-queue test
  queue-limit 2048
  tx-ring-limit 256
hostname(config)#
```

Viewing QoS Statistics

This section contains the following topics:

- [Viewing QoS Police Statistics, page 20-14](#)

- [Viewing QoS Priority Statistics, page 20-14](#)
- [Viewing QoS Priority Queue Statistics, page 20-15](#)

Viewing QoS Police Statistics

To view the QoS statistics for traffic policing, use the **show service-policy** command with the **police** keyword, in privileged EXEC mode:

```
hostname# show service-policy police
```



Note

This is the same command you use to view configuration of policies that include the **police** keyword.

For example, the following command displays service policies that include the **police** command and the related statistics; for example:

```
hostname# show service-policy police
```

```
Global policy:
  Service-policy: global_fw_policy

Interface outside:
  Service-policy: qos
  Class-map: browse
    police Interface outside:
      cir 56000 bps, bc 10500 bytes
      conformed 10065 packets, 12621510 bytes; actions: transmit
      exceeded 499 packets, 625146 bytes; actions: drop
      conformed 5600 bps, exceed 5016 bps
  Class-map: cmap2
    police Interface outside:
      cir 200000 bps, bc 37500 bytes
      conformed 17179 packets, 20614800 bytes; actions: transmit
      exceeded 617 packets, 770718 bytes; actions: drop
      conformed 198785 bps, exceed 2303 bps
```

Viewing QoS Priority Statistics

To view statistics for service policies implementing the **priority** command, use the **show service-policy** command with the **priority** keyword, in privileged EXEC mode:

```
hostname# show service-policy priority
```



Note

This is the same command you use to view configuration of policies that include the **priority** keyword.

For example, the following command displays service policies that include the **priority** command and the related statistics; for example:

```
hostname# show service-policy priority
Global policy:
  Service-policy: global_fw_policy
Interface outside:
  Service-policy: qos
  Class-map: TG1-voice
```

```
Priority:
Interface outside: aggregate drop 0, aggregate transmit 9383
```

**Note**

“Aggregate drop” denotes the aggregated drop in this interface; “aggregate transmit” denotes the aggregated number of transmitted packets in this interface.

Viewing QoS Priority Queue Statistics

To display the priority-queue statistics for an interface, use the **show priority-queue statistics** command in privileged EXEC mode. The results show the statistics for both the best-effort (BE) queue and the low-latency queue (LLQ). The following example shows the use of the **show priority-queue statistics** command for the interface named test, and the command output:

```
hostname# show priority-queue statistics test
```

```
Priority-Queue Statistics interface test
```

```
Queue Type      = BE
Packets Dropped = 0
Packets Transmit = 0
Packets Enqueued = 0
Current Q Length = 0
Max Q Length    = 0
```

```
Queue Type      = LLQ
Packets Dropped = 0
Packets Transmit = 0
Packets Enqueued = 0
Current Q Length = 0
Max Q Length    = 0
hostname#
```

In this statistical report, the meaning of the line items is as follows:

- “Packets Dropped” denotes the overall number of packets that have been dropped in this queue.
- “Packets Transmit” denotes the overall number of packets that have been transmitted in this queue.
- “Packets Enqueued” denotes the overall number of packets that have been queued in this queue.
- “Current Q Length” denotes the current depth of this queue.
- “Max Q Length” denotes the maximum depth that ever occurred in this queue.



Applying Application Layer Protocol Inspection

This chapter describes how to use and configure application inspection. This chapter includes the following sections:

- [Application Inspection Engines, page 21-1](#)
- [Applying Application Inspection to Selected Traffic, page 21-5](#)
- [Managing CTIQBE Inspection, page 21-10](#)
- [Managing DNS Inspection, page 21-14](#)
- [Managing FTP Inspection, page 21-22](#)
- [Managing GTP Inspection, page 21-28](#)
- [Managing H.323 Inspection, page 21-35](#)
- [Managing HTTP Inspection, page 21-41](#)
- [Managing IPsec Pass Through Inspection, page 21-45](#)
- [Managing MGCP Inspection, page 21-46](#)
- [Managing RTSP Inspection, page 21-52](#)
- [Managing SIP Inspection, page 21-55](#)
- [Managing Skinny \(SCCP\) Inspection, page 21-59](#)
- [Managing SMTP and Extended SMTP Inspection, page 21-63](#)
- [Managing SNMP Inspection, page 21-66](#)
- [Managing Sun RPC Inspection, page 21-69](#)

Application Inspection Engines

This section describes how application inspection engines work. This section includes the following topics:

- [Overview, page 21-2](#)
- [How Inspection Engines Work, page 21-2](#)
- [Supported Protocols, page 21-3](#)

Overview

The Adaptive Security Algorithm, used by the security appliance for stateful application inspection, ensures the secure use of applications and services. Some applications require special handling by the security appliance and specific application inspection engines are provided for this purpose.

Applications that require special application inspection engines are those that embed IP addressing information in the user data packet or open secondary channels on dynamically assigned ports.

Application inspection engines work with NAT to help identify the location of embedded addressing information. This allows NAT to translate these embedded addresses and to update any checksum or other fields that are affected by the translation.

Each application inspection engine also monitors sessions to determine the port numbers for secondary channels. Many protocols open secondary TCP or UDP ports to improve performance. The initial session on a well-known port is used to negotiate dynamically assigned port numbers. The application inspection engine monitors these sessions, identifies the dynamic port assignments, and permits data exchange on these ports for the duration of the specific session.

How Inspection Engines Work

As illustrated in [Figure 21-1](#), the security appliance uses three databases for its basic operation:

- Access lists —Used for authentication and authorization of connections based on specific networks, hosts, and services (TCP/UDP port numbers).
- Inspections—Contains a static, predefined set of application-level inspection functions.
- Connections (XLATE and CONN tables)—Maintains state and other information about each established connection. This information is used by the Adaptive Security Algorithm and cut-through proxy to efficiently forward traffic within established sessions.

Figure 21-1 Basic Adaptive Security Algorithm Operations

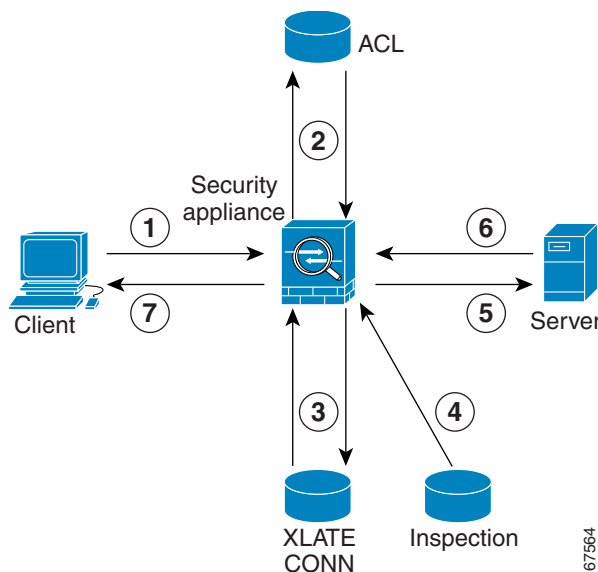

In [Figure 21-1](#), operations are numbered in the order they occur, and are described as follows:

1. A TCP SYN packet arrives at the security appliance to establish a new connection.
2. The security appliance checks the access list database to determine if the connection is permitted.
3. The security appliance creates a new entry in the connection database (XLATE and CONN tables).
4. The security appliance checks the Inspections database to determine if the connection requires application-level inspection.
5. After the application inspection engine completes any required operations for the packet, the security appliance forwards the packet to the destination system.
6. The destination system responds to the initial request.
7. The security appliance receives the reply packet, looks up the connection in the connection database, and forwards the packet because it belongs to an established session.

The default configuration of the security appliance includes a set of application inspection entries that associate supported protocols with specific TCP or UDP port numbers and that identify any special handling required. For certain applications some inspection engines do not support NAT or PAT because of the constraints imposed by the applications. You can change the port assignments for some applications, while other applications have fixed port assignments that you cannot change. [Table 21-1](#) summarizes this information about the application inspection engines provided with the security appliance.

Supported Protocols

[Table 21-1](#) summarizes the type of application inspections that is provided for each protocol supported by the security appliance. The following inspection engines are described in this chapter:

- CTIQBE—See the “[Managing CTIQBE Inspection](#)” section on page 21-10
- DNS—See the “[Managing DNS Inspection](#)” section on page 21-14
- FTP—See the “[Managing FTP Inspection](#)” section on page 21-22
- GTP—See the “[Managing GTP Inspection](#)” section on page 21-28
- H.323—See the “[Managing H.323 Inspection](#)” section on page 21-35
- HTTP—See the “[Managing HTTP Inspection](#)” section on page 21-41
- MGCP—See the “[Managing MGCP Inspection](#)” section on page 21-46
- RTSP—See the “[Managing RTSP Inspection](#)” section on page 21-52
- SIP—See the “[Managing SIP Inspection](#)” section on page 21-55
- Skinny—See the “[Managing Skinny \(SCCP\) Inspection](#)” section on page 21-59
- SMTP/ESMTP—See the “[Managing SMTP and Extended SMTP Inspection](#)” section on page 21-63
- SNMP—See the “[Managing SNMP Inspection](#)” section on page 21-66
- Sun RPC—See the “[Managing Sun RPC Inspection](#)” section on page 21-69

For more information about the inspection engines that are not discussed in this chapter, see the appropriate **inspect** command pages in the *Cisco Security Appliance Command Reference*.

Table 21-1 Application Inspection Engines

Application	PAT?	NAT (1-1)?	Configure Port?	Default Port	Standards	Comments
CTIQBE	Yes	Yes	Yes	TCP/2748	—	—
DNS ¹	Yes	Yes	No	UDP/53	RFC 1123	Only forward NAT. No PTR records are changed.
FTP	Yes	Yes	Yes	TCP/21	RFC 959	—
GTP	Yes	Yes	Yes	UDP/3386 UDP/2123	—	Requires a special license.
H.323	Yes	Yes	Yes	TCP/1720 UDP/1718 UDP (RAS) 1718-1719	ITU-T H.323, H.245, H225.0, Q.931, Q.932	
HTTP	Yes	Yes	Yes	TCP/80	RFC 2616	Beware of MTU limitations stripping ActiveX and Java. ²
ICMP	Yes	Yes	No	—	—	—
ICMP ERROR	Yes	Yes	No	—	—	—
ILS (LDAP)	Yes	Yes	Yes	—	—	—
MGCP	Yes	Yes	Yes	2427, 2727	RFC 2705bis-05	—
NBDS / UDP	Yes	Yes	No	UDP/138	—	—
NBNS / UDP	No	No	No	UDP/137	—	No WINS support.
NetBIOS over IP ³	No	No	No	—	—	—
PPTP	Yes	Yes	Yes	1723	RFC 2637	—
RSH	Yes	Yes	Yes	TCP/514	Berkeley UNIX	—
RTSP	No	No	Yes	TCP/554	RFC 2326, 2327, 1889	No handling for HTTP cloaking.
SIP	Yes	Yes	Yes	TCP/5060 UDP/5060	RFC 2543	—
SKINNY (SCCP)	Yes	Yes	Yes	TCP/2000	—	Does not handle TFTP uploaded Cisco IP Phone configurations under certain circumstances.
SMTP/ESMTP	Yes	Yes	Yes	TCP/25	RFC 821, 1123	—
SNMP	No	No	Yes	161, 162	RFC 1155, 1157, 1212, 1213, 1215	v.2 RFC 1902-1908; v.3 RFC 2570-2580.
SQL*Net	Yes	Yes	Yes	TCP/1521	—	v.1 and v.2.
Sun RPC	No	Yes	No	UDP/111 TCP/111	—	Payload not NATed.
XDCMP	No	No	No	UDP/177	—	—

1. No NAT support is available for name resolution through WINS.
2. If the MTU is too small to allow the Java or ActiveX tag to be included in one packet, stripping may not occur.
3. NetBIOS is supported by performing NAT of the packets for NBNS UDP port 137 and NBDS UDP port 138.

Applying Application Inspection to Selected Traffic

This section describes how to identify traffic to which you want to apply an inspection engine, how to associate the inspection engine with a particular security policy, and how to apply the policy to one or more interfaces on the security appliance. This section includes the following topics:

- [Overview, page 21-5](#)
- [Identifying Traffic with a Traffic Class Map, page 21-6](#)
- [Using an Application Inspection Map, page 21-8](#)
- [Defining Actions with a Policy Map, page 21-9](#)
- [Applying a Security Policy to an Interface, page 21-10](#)

Overview

Application inspection is enabled by default for many protocols, while it is disabled for other protocols. In most cases, you can change the port on which the application inspection listens for traffic. To change the default configuration for application inspection for any application inspection engine, use the Modular Policy Framework CLI.

Modular Policy Framework provides a consistent and flexible way to configure security appliance features in a manner to similar to Cisco IOS software Modular Quality of Server (QoS) CLI.

To use Modular Policy Framework to enable application inspection, perform the following steps:

Step 1 (Optional) Define a traffic class by entering the **class-map** command.

A traffic class is a set of traffic that is identifiable by its packet content. You only need to perform this step if you want to change the default port assignments for application inspection or identify traffic to be subjected to application inspection using other criteria, such as the IP address. For a list of default port assignments used for application inspection, see [Table 21-1](#).

Step 2 Create a policy map by associating the traffic class with one or more actions by entering the **policy-map** command.

An action is a security feature, such as application inspection, that helps protect information or resources on one or more protected network interfaces. Application inspection for a specific protocol is one type of action that can be applied using Modular Policy Framework.

Step 3 (Optional) Use an application inspection map to change the parameters used for certain application inspection engines.

The application inspection map command enables the configuration mode for a specific application inspection engine, from where you can enter the commands required to change the configuration. The supported application inspection map commands include the following:

- **ftp-map**—See [Managing FTP Inspection, page 21-22](#).
- **gtp-map**—See [Managing GTP Inspection, page 21-28](#).
- **http-map**—See [Managing HTTP Inspection, page 21-41](#).
- **mgcp-map**—See [Managing MGCP Inspection, page 21-46](#).
- **snmp-map**—See [Managing SNMP Inspection, page 21-66](#).

For detailed information about the syntax for each of these commands, see the *Cisco Security Appliance Command Reference*.

- Step 4** Create a security policy by associating the policy map with one or more interfaces by entering the **service-policy** command.

A security policy associates a previously defined traffic class with a security-related action and applies it to a specific interface.

You can associate more than one traffic class with a single action and more than one action with a specific traffic class. You can associate all interfaces with a traffic class by entering the **global** option, or multiple interfaces by entering the **service-policy** command on separate interfaces.

Identifying Traffic with a Traffic Class Map

A traffic class map contains a name and one **match** command. The match command identifies the traffic included in the traffic class. The name can be any string of alphanumeric characters.

Match commands can include different criteria to define the traffic included in the class map. For example, you can use one or more access lists to identify specific types of traffic. The **permit** command in an access control entry causes the traffic to be included, while a **deny** command causes the traffic to be excluded from the traffic class map. For more information about configuring access lists, see Chapter 9, “Identifying Traffic with Access Control Lists,” in the *Cisco Security Appliance Command Line Configuration Guide*.

After a traffic class is applied to an interface, packets received on that interface are compared to the criteria defined by the **match** commands in the class map.

If the packet matches the specified criteria, it is included in the traffic class and is subjected to any action, such as application inspection, that is associated with that traffic class. Packets that do not match any of the criteria in any traffic class are assigned to the default traffic class.

To define a traffic class map, perform the following steps:

- Step 1** To use an access list to define the traffic class, define the access list in global configuration mode, as in the following example:

```
hostname(config)# access-list http_acl permit tcp any any eq 80
```

The `http_acl` access list in this example includes traffic on port 80. To enable traffic on more than one non-contiguous port, enter the **access-list** command to create an access control entry for each port.

For the complete syntax of the **access-list** command see the **access-list** command page in the *Cisco Security Appliance Command Reference*.

- Step 2** Name the traffic class by entering the following command in global configuration mode:

```
hostname(config)# class-map class_map_name
```

Replace `class_map_name` with the name of the traffic class, as in the following example:

```
hostname(config)# class-map http_port
```

When you enter the **class-map** command, the CLI enters the class map configuration mode, and the prompt changes, as in the following example:

```
hostname(config-cmap)#
```

- Step 3** In the class map configuration mode, define the traffic to include in the class by entering the following command:

```
hostname(config-cmap)# match any | access-list acl_ID | {port tcp | udp {eq port_num | range port_num port_num}}
```

Use the **any** option to include all traffic in the traffic class. Use the **access-list** option to match the criteria defined in a specific access list. Use the **port** option to identify a specific port number or a range of port numbers.



Note For applications that use multiple ports that are not within a continuous range, enter the **access-list** option and define an access control entry to match each port.

The following example uses the **port** option to assign the default port to the current traffic class:

```
hostname(config-cmap)# match port tcp eq 80
```

The following example uses the **access-list** option to assign traffic identified by the access control entries in the http_acl access list:

```
hostname(config-cmap)# match access-list http_acl
```

You can also enter the **match** command to identify traffic based on IP precedence, DSCP (QoS) value, RTP port, or tunnel group. For the complete syntax of the **match** command, see the *Cisco Security Appliance Command Reference*.

- Step 4** To apply application inspection to the default port assignments for every application and protocol, enter the following command:

```
hostname(config-cmap)# match default-inspection-traffic
```

This command overrides any other port assignments made by entering another **match** command. However, it can be used with another match command that specifies other criteria, such as destination or source IP address. [Table 21-2](#) lists the default port assignments for different protocols.

Table 21-2 Default Port Assignments

Protocol Name	Protocol	Port
ctiqbe	tcp	2748
dns	udp	53
ftp	tcp	21
gtp	udp	2123,3386
h323 h225	tcp	1720
h323 ras	udp	1718-1719
http	tcp	80
icmp	icmp	N/A
ils	tcp	389
mgcp	udp	2427,2727
netbios	udp	N/A
sunrpc	udp	111
rsh	tcp	514

Table 21-2 Default Port Assignments (continued)

Protocol Name	Protocol	Port
rtsp	tcp	554
sip	tcp, udp	5060
skinny	tcp	2000
smtp	tcp	25
sqlnet	tcp	1521
tftp	udp	69
xdmcp	udp	177

Step 5 To return to global configuration mode, enter the following command:

```
hostname(config-cmap)# exit
hostname(config)#
```

Using an Application Inspection Map

Some application inspection engines have configurable parameters that are used to control application inspection. The default value of these parameters may work without modification, but if you need to fine tune control of the application inspection engine, use an application inspection map. The following procedure provides the general steps required to create an application inspection map.

To use an application inspection map, perform the following steps:

Step 1 Create an application inspection map by entering the following command:

```
hostname(config)# application-map application_map_name
```

Replace *application* with the type of application inspection. Replace *application_map_name* with the name of the application inspection map, for example:

```
hostname(config)# http-map inbound_http
```

This example causes the system to enter HTTP map configuration mode and the CLI prompt changes as follows:

```
hostname(config-http-map)#
```

Step 2 Define the configuration of the application inspection map by entering any of the supported commands. To display a list of the supported commands, type a question mark (?) from within the application.

```
hostname(config-http-map)# ?
Http-map configuration commands:
  content-length           Content length range inspection
  content-type-verification Content type inspection
  max-header-length       Maximum header size inspection
  max-uri-length          Maximum URI size inspection
  no                       Negate a command or set its defaults
  port-misuse             Application inspection
  request-method          Request method inspection
  strict-http             Strict HTTP inspection
  transfer-encoding       Transfer encoding inspection
```



```
hostname(config-http-map)# strict-http
hostname(config-http-map)#
```

Step 3 Return to global configuration mode:

```
hostname(config-http-map)# exit
hostname(config)#
```

Defining Actions with a Policy Map

You use a policy map to associate a traffic class map with a specific action, such as application inspection for a particular protocol. To define a policy map, assign a name to the policy with the **policy-map** command and then list one or more traffic class maps and one or more actions that should be taken on packets that belong to the given traffic class.



Note

A packet is assigned to the first matching traffic class in the policy map.

To create a policy map by associating an action with a traffic class, perform the following steps:

Step 1 Name the policy map by entering the following command:

```
hostname(config)# policy-map policy_map_name
```

For example, the following command creates or modifies the `sample_policy` policy map:

```
(config)# policy-map sample_policy
```

The CLI enters the policy map configuration mode and the prompt changes accordingly, as follows:

```
hostname(config-pmap)#
```

Step 2 Specify one or more traffic classes to be included in the traffic policy, as in the following example:

```
hostname(config-pmap)# class class_map_name
```

For example, the following command creates the `http_port` policy map:

```
hostname(config-pmap)# class http_port
```

The CLI enters the class map configuration mode and the prompt changes accordingly, as follows:

```
hostname(config-pmap-c)#
```

Step 3 Enable application inspection by entering the following command:

```
hostname(config-pmap-c)# inspect protocol application_inspection_map
```

Use *application_inspection_map* if you are enabling a protocol that uses an application map for setting configurable parameters. For example, the following command enables HTTP application inspection using the parameters defined using the `http_traffic` application inspection map.

```
hostname(config-pmap-c)# inspect http http_traffic
```

Step 4 To return to policy map configuration mode, enter the following command:

```
hostname(config-pmap-c)# exit
hostname(config-pmap)#
```

Step 5 To return to global configuration mode, enter the following command:

```
hostname(config-pmap-c)# exit
```

Applying a Security Policy to an Interface

After defining the policy map, apply the policy map to one or more interfaces on the security appliance by entering the **service-policy** command in global configuration mode. You can enter the **service-policy** command to activate a policy map globally on all the security appliance interfaces or on a specific interface.

For example, the following command enables the `sample_policy` service policy on the `outside` interface:

```
hostname(config)# service-policy sample_policy interface outside
```

To enable the `sample_policy` service policy on all the security appliance interfaces, enter the following command:

```
hostname(config)# service-policy sample_policy global
```

Managing CTIQBE Inspection

This section describes how to enable CTIQBE application inspection and change the default port configuration. This section includes the following topics:

- [CTIQBE Inspection Overview, page 21-10](#)
- [Limitations and Restrictions, page 21-10](#)
- [Enabling and Configuring CTIQBE Inspection, page 21-11](#)
- [Verifying and Monitoring CTIQBE Inspection, page 21-13](#)

CTIQBE Inspection Overview

The **inspect ctiqbe 2748** command enables CTIQBE protocol inspection, which supports NAT, PAT, and bidirectional NAT. This enables Cisco IP SoftPhone and other Cisco TAPI/JTAPI applications to work successfully with Cisco CallManager for call setup across the security appliance.

TAPI and JTAPI are used by many Cisco VoIP applications. CTIQBE is used by Cisco TSP to communicate with Cisco CallManager.

Limitations and Restrictions

The following summarizes limitations that apply when using CTIQBE application inspection:

- CTIQBE application inspection does not support configurations with the **alias** command.
- Stateful Failover of CTIQBE calls is *not* supported.

- Entering the **debug ctiqbe** command may delay message transmission, which may have a performance impact in a real-time environment. When you enable this debugging or logging and Cisco IP SoftPhone seems unable to complete call setup through the security appliance, increase the timeout values in the Cisco TSP settings on the system running Cisco IP SoftPhone.

The following summarizes special considerations when using CTIQBE application inspection in specific scenarios:

- If two Cisco IP SoftPhones are registered with different Cisco CallManagers, which are connected to different interfaces of the security appliance, calls between these two phones fails.
- When Cisco CallManager is located on the higher security interface compared to Cisco IP SoftPhones, if NAT or outside NAT is required for the Cisco CallManager IP address, the mapping must be static as Cisco IP SoftPhone requires the Cisco CallManager IP address to be specified explicitly in its Cisco TSP configuration on the PC.
- When using PAT or Outside PAT, if the Cisco CallManager IP address is to be translated, its TCP port 2748 must be statically mapped to the **same port** of the PAT (interface) address for Cisco IP SoftPhone registrations to succeed. The CTIQBE listening port (TCP 2748) is fixed and is not user-configurable on Cisco CallManager, Cisco IP SoftPhone, or Cisco TSP.

Enabling and Configuring CTIQBE Inspection

To enable CTIQBE inspection or change the default port used for receiving CTIQBE traffic, perform the following steps:

- Step 1** Name the traffic class by entering the following command in global configuration mode:

```
hostname(config)# class-map class_map_name
```

Replace *class_map_name* with the name of the traffic class, For example:

```
hostname(config)# class-map ctiqbe_port
```

When you enter the **class-map** command, the CLI enters the class map configuration mode, and the prompt changes, as in the following example:

```
hostname(config-cmap)#
```

- Step 2** In the class map configuration mode, define the **match** command, as in the following example:

```
hostname(config-cmap)# match port tcp eq 2748
hostname(config-cmap)# exit
hostname(config)#
```

To assign a range of continuous ports, enter the **range** keyword, as in the following example:

```
hostname(config-cmap)# match port tcp range 2748-2750
```

To assign more than one non-contiguous port for CTIQBE inspection, enter the **access-list** command and define an access control entry to match each port. Then enter the **match** command to associate the access lists with the CTIQBE traffic class.

- Step 3** Name the policy map by entering the following command:

```
hostname(config)# policy-map policy_map_name
```

Replace *policy_map_name* with the name of the policy map, as in the following example:

```
hostname(config)# policy-map sample_policy
```

The CLI enters the policy map configuration mode and the prompt changes accordingly, as follows:

```
hostname(config-pmap)#
```

- Step 4** Specify the traffic class defined in [Step 1](#) to be included in the policy map by entering the following command:

```
hostname(config-pmap)# class class_map_name
```

For example, the following command assigns the `ctiqbe_port` traffic class to the current policy map:

```
hostname(config-pmap)# class ctiqbe_port
```

The CLI enters the policy map class configuration mode and the prompt changes accordingly, as follows:

```
hostname(config-pmap-c)#
```

- Step 5** To enable CTIQBE application inspection, enter the following command:

```
hostname(config-pmap-c)# inspect ctiqbe
```

- Step 6** Return to policy map configuration mode by entering the following command:

```
hostname(config-pmap-c)# exit
hostname(config-pmap)#
```

- Step 7** Return to global configuration mode by entering the following command:

```
hostname(config-pmap)# exit
hostname(config)#
```

- Step 8** Apply the policy map globally or to a specific interface by entering the following command:

```
hostname(config)# service-policy policy_map_name [global | interface interface_ID
```

Replace `policy_map_name` with the policy map you configured in [Step 3](#), and identify all the interfaces with the **global** option or a specific interface using the name assigned with the **nameif** command.

For example, the following command applies the `sample_policy` to the `outside` interface:

```
hostname(config)# service-policy sample_policy interface outside
```

The following command applies the `sample_policy` to all the security appliance interfaces:

```
hostname(config)# service-policy sample_policy global
```

Example 21-1 Enabling and Configuring CTIQBE Inspection

You enable the CTIQBE inspection engine as shown in the following example, which creates a class map to match CTIQBE traffic on the default port (2748). The service policy is then applied to the `outside` interface.

```
hostname(config)# class-map ctiqbe_port
hostname(config-cmap)# match port tcp eq 2748
hostname(config-cmap)# exit
hostname(config)# policy-map sample_policy
hostname(config-pmap)# class ctiqbe_port
hostname(config-pmap-c)# inspect ctiqbe
hostname(config-pmap-c)# exit
hostname(config)# service-policy sample_policy interface outside
```

To enable CTIQBE inspection for all interfaces, enter the **global** parameter in place of **interface outside**.

Verifying and Monitoring CTIQBE Inspection

The **show ctiqbe** command displays information regarding the CTIQBE sessions established across the security appliance. It shows information about the media connections allocated by the CTIQBE inspection engine.

The following is sample output from the **show ctiqbe** command under the following conditions. There is only one active CTIQBE session setup across the security appliance. It is established between an internal CTI device (for example, a Cisco IP SoftPhone) at local address 10.0.0.99 and an external Cisco CallManager at 172.29.1.77, where TCP port 2748 is the Cisco CallManager. The heartbeat interval for the session is 120 seconds.

```
hostname# # show ctiqbe

Total: 1
      LOCAL          FOREIGN          STATE    HEARTBEAT
-----
1     10.0.0.99/1117  172.29.1.77/2748      1        120
-----
RTP/RTCP: PAT xlates: mapped to 172.29.1.99(1028 - 1029)
-----
MEDIA: Device ID 27      Call ID 0
      Foreign 172.29.1.99      (1028 - 1029)
      Local   172.29.1.88      (26822 - 26823)
-----
```

The CTI device has already registered with the CallManager. The device internal address and RTP listening port is PATed to 172.29.1.99 UDP port 1028. Its RTCP listening port is PATed to UDP 1029.

The line beginning with **RTP/RTCP: PAT xlates:** appears only if an internal CTI device has registered with an external CallManager and the CTI device address and ports are PATed to that external interface. This line does not appear if the CallManager is located on an internal interface, or if the internal CTI device address and ports are NATed to the same external interface that is used by the CallManager.

The output indicates a call has been established between this CTI device and another phone at 172.29.1.88. The RTP and RTCP listening ports of the other phone are UDP 26822 and 26823. The other phone locates on the same interface as the CallManager because the security appliance does not maintain a CTIQBE session record associated with the second phone and CallManager. The active call leg on the CTI device side can be identified with Device ID 27 and Call ID 0.

The following is sample output from the **show xlate debug** command for these CTIBQE connections:

```
hostname# show xlate debug
3 in use, 3 most used
Flags: D - DNS, d - dump, I - identity, i - inside, n - no random,
      r - portmap, s - static
TCP PAT from inside:10.0.0.99/1117 to outside:172.29.1.99/1025 flags ri idle 0:00:22
timeout 0:00:30
UDP PAT from inside:10.0.0.99/16908 to outside:172.29.1.99/1028 flags ri idle 0:00:00
timeout 0:04:10
UDP PAT from inside:10.0.0.99/16909 to outside:172.29.1.99/1029 flags ri idle 0:00:23
timeout 0:04:10
```

The **show conn state ctiqbe** command displays the status of CTIQBE connections. In the output, the media connections allocated by the CTIQBE inspection engine are denoted by a 'C' flag. The following is sample output from the **show conn state ctiqbe** command:

```
hostname# show conn state ctiqbe
1 in use, 10 most used
hostname# show conn state ctiqbe detail
1 in use, 10 most used
Flags: A - awaiting inside ACK to SYN, a - awaiting outside ACK to SYN,
```

B - initial SYN from outside, C - CTIQBE media, D - DNS, d - dump,
 E - outside back connection, F - outside FIN, f - inside FIN,
 G - group, g - MGCP, H - H.323, h - H.225.0, I - inbound data,
 i - incomplete, J - GTP, j - GTP data, k - Skinny media,
 M - SMTP data, m - SIP media, O - outbound data, P - inside back connection,
 q - SQL*Net data, R - outside acknowledged FIN,
 R - UDP RPC, r - inside acknowledged FIN, S - awaiting inside SYN,
 s - awaiting outside SYN, T - SIP, t - SIP transient, U - up

Managing DNS Inspection

This section describes how to manage DNS application inspection. This section includes the following topics:

- [How DNS Application Inspection Works, page 21-14](#)
- [How DNS Rewrite Works, page 21-15](#)
- [Configuring DNS Rewrite, page 21-16](#)
- [Configuring DNS Inspection, page 21-20](#)
- [Verifying and Monitoring DNS Inspection, page 21-21](#)

How DNS Application Inspection Works

DNS guard tears down the DNS session associated with a DNS query as soon as the DNS reply is forwarded by the security appliance. DNS guard also monitors the message exchange to ensure that the ID of the DNS reply matches the ID of the DNS query.

When DNS inspection is enabled, which it is the default, the security appliance performs the following additional tasks:

- Translates the DNS record based on the configuration completed using the **alias**, **static** and **nat** commands (DNS rewrite). Translation only applies to the A-record in the DNS reply. Therefore, reverse lookups, which request the PTR record, are not affected by DNS rewrite.



Note DNS rewrite is not applicable for PAT because multiple PAT rules are applicable for each A-record and the PAT rule to use is ambiguous.

- Enforces the maximum DNS message length (the default is 512 bytes and the maximum length is 65535 bytes). Reassembly is performed as necessary to verify that the packet length is less than the maximum length configured. The packet is dropped if it exceeds the maximum length.



Note If you enter the **inspect dns** command without the **maximum-length** option, DNS packet size is not checked

- Enforces a domain-name length of 255 bytes and a label length of 63 bytes.
- Verifies the integrity of the domain-name referred to by the pointer if compression pointers are encountered in the DNS message.
- Checks to see if a compression pointer loop exists.

A single connection is created for multiple DNS sessions, as long as they are between the same two hosts, and the sessions have the same 5-tuple (source/destination IP address, source/destination port, and protocol). DNS identification is tracked by *app_id*, and the idle timer for each *app_id* runs independently.

Because the *app_id* expires independently, a legitimate DNS response can only pass through the security appliance within a limited period of time and there is no resource build-up. However, if you enter the **show conn** command, you will see the idle timer of a DNS connection being reset by a new DNS session. This is due to the nature of the shared DNS connection and is by design.

DNS port redirection can be enabled using the **static** command, as in the following example:

```
static (inside,outside) udp x.x.x.x 53 10.1.1.1 8053
```

In this example, the DNS server listens on port 8053 and the security appliance redirects DNS queries on port 53 to port 8053. For this to work with DNS inspection, you must enable DNS inspection on port 8053. For configuration instructions, see the [“Configuring DNS Inspection” section on page 21-20](#).

How DNS Rewrite Works

When DNS inspection is enabled, DNS rewrite provides full support for NAT of DNS messages originating from any interface.

If a client on an inside network requests DNS resolution of an inside address from a DNS server on an outside interface, the DNS A-record is translated correctly. If the DNS inspection engine is disabled, the A-record is not translated.

As long as DNS inspection remains enabled, you can configure DNS rewrite using the **alias**, **static**, or **nat** commands. For details about the configuration required see the [“Configuring DNS Rewrite” section on page 21-16](#).

DNS rewrite performs two functions:

- Translating a public address (the routable or “mapped” address) in a DNS reply to a private address (the “real” address) when the DNS client is on a private interface.
- Translating a private address to a public address when the DNS client is on the public interface.

In [Figure 21-2](#), the DNS server resides on the external (ISP) network. The real address of the server (192.168.100.1) has been mapped using the **static** command to the ISP-assigned address (209.165.200.5). A client on any interface can issue an HTTP request to a server. For configuration instructions for this scenario, see the [“Configuring DNS Rewrite” section on page 21-17](#).

Figure 21-2 Translating the Address in a DNS Reply (DNS Rewrite)

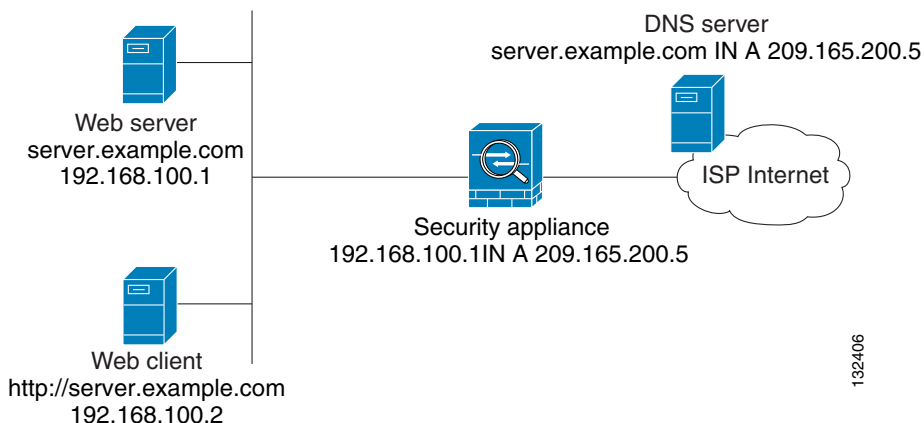

A client on any interface can issue a DNS request using “server.example.com.” When the DNS request is sent to the external DNS server, the security appliance translates the non-routable source address in the IP header and forwards the request to the ISP network on its outside interface. When the DNS reply is returned, the security appliance applies address translation not only to the destination address, but also to the embedded IP address of the web server, which is contained in the A-record in the DNS reply. As a result, the web client on the inside network gets the correct address for connecting to the web server on the inside network.

DNS rewrite also works if the client making the DNS request is on a DMZ network and the DNS server is on an inside interface. For an illustration and configuration instructions for this scenario, see the “[DNS Rewrite with Three NAT Zones](#)” section on page 21-18.

Configuring DNS Rewrite

You configure DNS rewrite using the **alias**, **static**, or **nat** commands. The **alias** and **static** command can be used interchangeably. However, Cisco recommends using the **static** command for new deployments because it is more precise and unambiguous. Also, DNS rewrite is optional when using the **static** command.

This section describes how to use the **alias** and **static** commands to configure DNS rewrite. It provides configuration procedures for using the **static** command in a simple scenario and in a more complex scenario. Using the **nat** command is similar to using the **static** command except that DNS rewrite is based on dynamic translation instead of a static mapping.

This section includes the following topics:

- [Using the Alias Command for DNS Rewrite, page 21-17](#)
- [Using the Static Command for DNS Rewrite, page 21-17](#)
- [Configuring DNS Rewrite, page 21-17](#)
- [DNS Rewrite with Three NAT Zones, page 21-18](#)
- [Configuring DNS Rewrite with Three NAT Zones, page 21-19](#)

For detailed syntax and additional functions for the **alias**, **nat**, and **static** command, see the appropriate command page in the *Cisco Security Appliance Command Line Configuration Guide*.

Using the Alias Command for DNS Rewrite

The **alias** command causes addresses on an IP network residing on *any* interface to be translated into addresses on another IP network connected through a different interface. The syntax for this command is as follows:

```
hostname(config)# alias (inside) mapped-address real-address
```

For example:

```
hostname(config)# alias (inside) 209.165.200.5 192.168.100.10
```

This command specifies that the real address (192.168.100.10) on any interface *except* the inside interface will be translated to the mapped address (209.165.200.5) on the inside interface. Note that the location of 192.168.100.10 is not precisely defined.



Note

If you use the **alias** command to configure DNS rewrite, proxy ARP will be performed for the mapped address. To prevent this, disable Proxy ARP by entering the **sysopt noproxyarp internal_interface** command after entering the **alias** command.

Using the Static Command for DNS Rewrite

The **static** command causes addresses on an IP network residing on a *specific* interface to be translated into addresses on another IP network on a different interface. The syntax for this command is as follows:

```
hostname(config)# static (inside,outside) mapped-address real-address dns
```

For example:

```
hostname(config)# static (inside,outside) 209.165.200.5 192.168.100.10 dns
```

This command specifies that the address 192.168.100.10 on the inside interface is translated into 209.165.200.5 on the outside interface.



Note

Using the **nat** command is similar to using the **static** command except that DNS rewrite is based on dynamic translation instead of a static mapping.

Configuring DNS Rewrite

To implement the DNS rewrite scenario shown in [Figure 21-2](#), perform the following steps:

- Step 1** Create a static translation for the web server as shown in the following example:

```
hostname(config)# static (inside,outside) 209.165.200.5 192.168.100.1 netmask  
255.255.255.255 dns
```

This command creates a static translation between the web server real address of 192.168.100.1 to the global IP address 209.165.200.5.

- Step 2** To grant access to anyone on the Internet to the web server on port 80, enter the following commands:

```
hostname(config)# access-list 101 permit tcp any host 209.165.200.5 eq www  
hostname(config)# access-group 101 in interface outside
```

These commands permit any outside user to access the web server on port 80.

Step 3 Configure DNS Inspection if it has been previously disabled or if you want to change the maximum DNS packet length.

DNS application inspection is enabled by default with a maximum DNS packet length of 512 bytes. For configuration instructions, see the [“Limitations and Restrictions”](#) section on page 21-10.

Step 4 On the public DNS server, add an A-record into the example.com zone, for example:

```
server.example.com. IN A 209.165.200.5
```

This DNS A-record binds the name server.example.com to the IP address 209.165.200.5.

DNS Rewrite with Three NAT Zones

Figure 21-3 provides a more complex scenario to illustrate how DNS inspection allows NAT to operate transparently with a DNS server with minimal configuration. For configuration instructions for this scenario, see the [“Configuring DNS Rewrite with Three NAT Zones”](#) section on page 21-19.

Figure 21-3 Configuring DNS Rewrite with Three NAT Zones

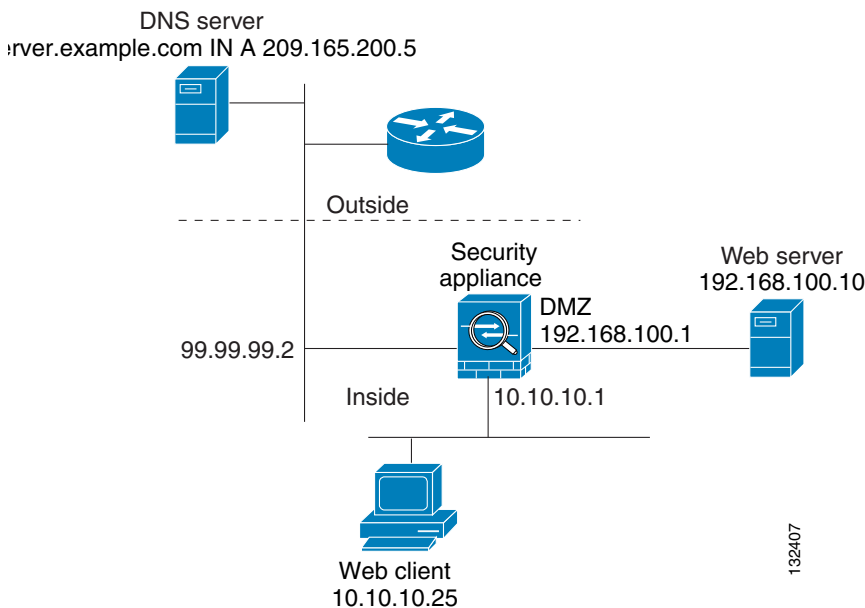

In Figure 21-3, a web server, server.example.com, has the real address 192.168.100.10 on the dmz interface of the security appliance. A web client with the IP address 10.10.10.25 is on the inside interface and a public DNS server is on the outside interface. The site NAT policies are as follows:

- The outside DNS server holds the authoritative address record for server.example.com.
- Hosts on the outside network can contact the web server with the domain name server.example.com through the outside DNS server or with the IP address 209.165.200.5.
- Clients on the inside network can access the web server with the domain name server.example.com through the outside DNS server or with the IP address 192.168.100.10.

When a host or client on any interface accesses the DMZ web server, it queries the public DNS server for the A-record of server.example.com. The DNS server returns the A-record showing that server.example.com binds to address 209.165.200.5.

When the request comes from the outside network, the sequence of events is as follows:

1. The outside host accesses the DNS server using the IP address 209.165.200.5.
2. The packet from the outside host reaches the security appliance at the outside interface to access destination 209.165.200.5.
3. The static rule translates the address 209.165.200.5 to 192.168.100.10 and the packet is directed to the web server on the DMZ.

When the request comes from the inside network, the sequence of events is as follows:

1. The DNS reply reaches the security appliance and is directed to the DNS application inspection engine.
2. The DNS application inspection engine does the following:
 - a. Searches for any NAT rule to undo the translation of the embedded A-record address “[outside]:209.165.200.5”. In this example, it finds the following static configuration:

```
static (dmz,outside) 209.165.200.5 192.168.100.10 dns
```

- b. Uses the static rule to rewrite the A-record as follows because the **dns** option is included:

```
[outside]:209.165.200.5 --> [dmz]:192.168.100.10
```

If the **dns** option were not included with the **static** command, DNS rewrite would not be performed and other processing for the packet continues.

- c. Searches for any NAT to translate the web server address, [dmz]:192.168.100.10, when communicating with the inside web client.

No NAT rule is applicable, so application inspection completes.

If a NAT rule (nat or static) were applicable, the **dns** option must also be specified. If the **dns** option were not specified, the A-record rewrite in step (b) would be reverted and other processing for the packet continues.

Configuring DNS Rewrite with Three NAT Zones

To enable the NAT policies for the scenario in [Figure 21-3](#), perform the following steps:

- Step 1** Configure a NAT rule for the DMZ server and DNS rewrite for the DMZ server address.

```
hostname(config)# static (dmz,outside) 209.165.200.5 192.168.100.10 dns
```

This configuration states that hosts on the outside network can access the web server dmz:192.168.100.10 using the address 209.165.200.5. Additionally, the **dns** option allows the static rule to be used by DNS application inspection to rewrite the DNS A-record.

- Step 2** Configure DNS Inspection if it has been previously disabled or if you want to change the maximum DNS packet length.

DNS application inspection is enabled by default with a maximum DNS packet length of 512 bytes. For configuration instructions, see the [“Limitations and Restrictions”](#) section on page 21-10.

- Step 3** To grant access to anyone on the Internet to the web server on port 80, enter the following commands:

```
hostname(config)# access-list 101 permit tcp any host 209.165.200.5 eq www
hostname(config)# access-group 101 in interface outside
```

These commands permit any outside user to access the web server on port 80.

- Step 4** On the public DNS server, add an A-record into the example.com zone, for example:

```
server.example.com. IN A 209.165.200.5
```

This DNS A-record binds the name server.example.com to the IP address 209.165.200.5.

Configuring DNS Inspection

To enable DNS inspection (if it has been previously disabled) or to change the default port used for receiving DNS traffic, perform the following steps:

- Step 1** Name the traffic class by entering the following command in global configuration mode:

```
hostname(config)# class-map class_map_name
```

Replace *class_map_name* with the name of the traffic class, For example:

```
hostname(config)# class-map dns_port
```

When you enter the **class-map** command, the CLI enters the class map configuration mode, and the prompt changes, as in the following example:

```
hostname(config-cmap)#
```

- Step 2** In the class map configuration mode, define the **match** command, as in the following example:

```
hostname(config-cmap)# match port udp eq 8053
hostname(config-cmap)# exit
hostname(config)#
```

- Step 3** Name the policy map by entering the following command:

```
hostname(config)# policy-map policy_map_name
```

Replace *policy_map_name* with the name of the policy map, as in the following example:

```
hostname(config)# policy-map sample_policy
```

The CLI enters the policy map configuration mode and the prompt changes accordingly, as follows:

```
hostname(config-pmap)#
```

- Step 4** Specify the traffic class defined in [Step 1](#) to be included in the policy map by entering the following command:

```
hostname(config-pmap)# class class_map_name
```

For example, the following command assigns the dns_port traffic class to the current policy map:

```
hostname(config-pmap)# class dns_port
```

The CLI enters the policy map class configuration mode and the prompt changes accordingly, as follows:

```
hostname(config-pmap-c)#
```

- Step 5** To enable DNS application inspection, enter the following command:

```
hostname(config-pmap-c)# inspect dns maximum-length [max-pkt-length]
```

To change the maximum DNS packet length from the default (512), replace *max-pkt-length* with a numeric value. Longer packets will be dropped. To disable checking the DNS packet length, enter the **inspect dns** command without the **maximum-length** option.

Step 6 Return to policy map configuration mode by entering the following command:

```
hostname(config-pmap-c)# exit
hostname(config-pmap)#
```

Step 7 Return to global configuration mode by entering the following command:

```
hostname(config-pmap)# exit
hostname(config)#
```

Step 8 Apply the policy map globally or to a specific interface by entering the following command:

```
hostname(config)# service-policy policy_map_name [global | interface interface_ID
```

Replace *policy_map_name* with the policy map you configured in [Step 3](#), and identify all the interfaces with the **global** option or a specific interface using the name assigned with the **nameif** command.

For example, the following command applies the *sample_policy* to the *outside* interface:

```
hostname(config)# service-policy sample_policy interface outside
```

The following command applies the *sample_policy* to all the security appliance interfaces:

```
hostname(config)# service-policy sample_policy global
```

Example 21-2 Enabling and Configuring DNS Inspection

You enable the DNS inspection engine as shown in the following example, which creates a class map to match DNS traffic on port 8053. The service policy is then applied to the *outside* interface.

```
hostname(config)# class-map dns_port
hostname(config-cmap)# match port udp eq 8053
hostname(config-cmap)# exit
hostname(config)# policy-map sample_policy
hostname(config-pmap)# class dns_port
hostname(config-pmap-c)# inspect dns maximum-length 1500
hostname(config-pmap-c)# exit
hostname(config)# service-policy sample_policy interface outside
```

To configure DNS inspection for all interfaces, enter the **global** parameter in place of **interface outside**.

Verifying and Monitoring DNS Inspection

To view information about the current DNS connections, enter the following command:

```
hostname# show conn
```

For connections using a DNS server, the source port of the connection may be replaced by the IP address of DNS server in the *show conn* command output.

A single connection is created for multiple DNS sessions, as long as they are between the same two hosts, and the sessions have the same 5-tuple (source/destination IP address, source/destination port, and protocol). DNS identification is tracked by *app_id*, and the idle timer for each *app_id* runs independently.

Because the `app_id` expires independently, a legitimate DNS response can only pass through the security appliance within a limited period of time and there is no resource build-up. However, when you enter the `show conn` command, you will see the idle timer of a DNS connection being reset by a new DNS session. This is due to the nature of the shared DNS connection and is by design.

To display the statistics for DNS application inspection, enter the `show service-policy` command. The following is sample output from the `show service-policy` command:

```
hostname# show service-policy
Interface outside:
  Service-policy: sample_policy
  Class-map: dns_port
    Inspect: dns maximum-length 1500, packet 0, drop 0, reset-drop 0
```

Managing FTP Inspection

This section describes how the FTP inspection engine works and how you can change its configuration. This section includes the following topics:

- [FTP Inspection Overview, page 21-22](#)
- [Using the strict Option, page 21-22](#)
- [Configuring FTP Inspection, page 21-23](#)
- [Verifying and Monitoring FTP Inspection, page 21-26](#)

FTP Inspection Overview

The FTP application inspection inspects the FTP sessions and performs four tasks:

- Prepares dynamic secondary data connection
- Tracks `ftp` command-response sequence
- Generates an audit trail
- NATs embedded IP address

FTP application inspection prepares secondary channels for FTP data transfer. The channels are allocated in response to a file upload, a file download, or a directory listing event and must be pre-negotiated. The port is negotiated through the `PORT` or `PASV` commands.



Note

If you disable FTP inspection engines with the `no inspect ftp` command, outbound users can start connections only in passive mode, and all inbound FTP is disabled.

Using the strict Option

The `strict` option increases the security of protected networks by preventing web browsers from sending embedded commands in FTP requests.



Note

To specify FTP commands that are not permitted to pass through the security appliance, create an FTP map and enter the `request-command deny` command in FTP map configuration mode.

After enabling the **strict** option on an interface, an **ftp** command must be acknowledged before a new command is allowed. Connections sending embedded commands are dropped. The **strict** option restricts an FTP server to generating the 227 command and restricts the FTP client to generating the PORT command. The 227 and PORT commands are further checked to ensure they do not appear in an error string.

**Caution**

Entering the **strict** option may break FTP clients that do not comply strictly to the RFC standards.

If the **strict** option is enabled, each **ftp** command and response sequence is tracked for the following anomalous activity:

- Truncated command—Number of commas in the PORT and PASV reply command is checked to see if it is five. If it is not five, then the PORT command is assumed to be truncated and the TCP connection is closed.
- Incorrect command—Checks the **ftp** command to see if it ends with <CR><LF> characters, as required by the RFC. If it does not, the connection is closed.
- Size of RETR and STOR commands—These are checked against a fixed constant. If the size is greater, then an error message is logged and the connection is closed.
- Command spoofing—The PORT command should always be sent from the client. The TCP connection is denied if a PORT command is sent from the server.
- Reply spoofing—PASV reply command (227) should always be sent from the server. The TCP connection is denied if a PASV reply command is sent from the client. This prevents the security hole when the user executes “227 xxxxx a1, a2, a3, a4, p1, p2.”
- TCP stream editing.
- Invalid port negotiation—The negotiated dynamic port value is checked to see if it is less than 1024. As port numbers in the range from 1 to 1024 are reserved for well-known connections, if the negotiated port falls in this range, then the TCP connection is freed.
- Command pipelining—The number of characters present after the port numbers in the PORT and PASV reply command is cross checked with a constant value of 8. If it is more than 8, then the TCP connection is closed.
- The security appliance replaces the FTP server response to the SYST command with a series of Xs. to prevent the server from revealing its system type to FTP clients. To override this default behavior, use the **no mask-syst-reply** command in FTP map configuration mode.

Configuring FTP Inspection

FTP application inspection is enabled default, so you only need to perform the procedures in this section if you want to change the default FTP configuration, in any of the following ways:

- Enable the **strict** option.
- Identify specific FTP commands that are not permitted to pass through the security appliance.
- Change the default port number.

To change the default configuration for FTP inspection, perform the following steps:

- Step 1** Name the traffic class by entering the following command in global configuration mode:

```
hostname(config)# class-map class_map_name
```

Replace *class_map_name* with the name of the traffic class, as in the following example:

```
hostname(config)# class-map ftp_port
```

When you enter the **class-map** command, the CLI enters the class map configuration mode, and the prompt changes, as in the following example:

```
hostname(config-cmap)#
```

- Step 2** In the class map configuration mode, define the **match** command, as in the following example:

```
hostname(config-cmap)# match port tcp eq 23
hostname(config-cmap)# exit
hostname(config)#
```

To assign a range of continuous ports, enter the **range** keyword, as in the following example:

```
hostname(config-cmap)# match port tcp range 1023-1025
```

To assign more than one non-contiguous port for FTP inspection, enter the **access-list** command and define an access control entry to match each port. Then enter the **match** command to associate the access lists with the FTP traffic class.

- Step 3** Create an FTP map by entering the following command:

```
hostname(config)# ftp-map ftp_map_name
```

Replace *ftp_map_name* with the name of the FTP map, for example:

```
hostname(config)# ftp-map inbound_ftp
```

The system enters FTP map configuration mode and the CLI prompt changes as in the following example:

```
hostname(config-ftp-map)#
```

- Step 4** Define the configuration of the FTP map by entering the following command:

```
hostname(config-ftp-map)# request-command deny ftp_command
hostname(config-ftp-map)# exit
hostname(config)#
```

Replace *ftp_command* with one or more FTP commands that you want to restrict. See [Table 21-3](#) for a list of the FTP commands that you can restrict. For example, the following command prevents storing or appending files:

```
hostname(config-inbound_ftp)# request-command deny put stou appe
```



Note

When FTP inspection is enabled, the security appliance replaces the FTP server response to the SYST command with a series of Xs. This prevents the server from revealing its system type to FTP clients. To change this default behavior, use the **no mask-syst-reply** command in FTP map configuration mode.

Step 5 Name the policy map by entering the following command:

```
hostname(config)# policy-map policy_map_name
```

Replace *policy_map_name* with the name of the policy map, as in the following example:

```
hostname(config)# policy-map sample_policy
```

The CLI enters the policy map configuration mode and the prompt changes accordingly, as follows:

```
hostname(config-pmap)#
```

Step 6 Specify the traffic class defined in [Step 1](#) to be included in the policy map by entering the following command:

```
hostname(config-pmap)# class class_map_name
```

For example, the following command assigns the ftp_port traffic class to the current policy map.

```
hostname(config-pmap)# class ftp_port
```

The CLI enters the policy map class configuration mode and the prompt changes accordingly, as follows:

```
hostname(config-pmap-c)#
```

Step 7 To apply strict inspection to the traffic that matches the criteria defined in the traffic class, enter the following command:

```
hostname(config-pmap-c)# inspect strict ftp ftp_map_name
```

Replace *ftp_map_name* with the FTP map that you want to use. For example, the following command causes the security appliance to use the FTP map created in the previous steps.

```
hostname(config-pmap-c)# inspect ftp strict inbound_ftp
```

Step 8 Return to policy map configuration mode by entering the following command:

```
hostname(config-pmap-c)# exit  
hostname(config-pmap)#
```

Step 9 Return to global configuration mode by entering the following command:

```
hostname(config-pmap)# exit  
hostname(config)#
```

Step 10 Apply the policy map globally or to a specific interface by entering the following command:

```
hostname(config)# service-policy policy_map_name [global | interface interface_ID]
```

Replace *policy_map_name* with the policy map you configured in [Step 5](#), and identify all the interfaces with the **global** option or a specific interface using the name assigned with the **nameif** command.

For example, the following command applies the sample_policy to the outside interface:

```
hostname(config)# service-policy sample_policy interface outside
```

The following command applies the sample_policy to the all the security appliance interfaces:

```
hostname(config)# service-policy sample_policy global
```

Table 21-3 FTP Map request-command deny Options

request-command deny Option	Purpose
appe	Disallows the command that appends to a file.
cdup	Disallows the command that changes to the parent directory of the current working directory.
dele	Disallows the command that deletes a file on the server.
get	Disallows the client command for retrieving a file from the server.
help	Disallows the command that provides help information.
mkd	Disallows the command that makes a directory on the server.
put	Disallows the client command for sending a file to the server.
rmd	Disallows the command that deletes a directory on the server.
rnfr	Disallows the command that specifies rename-from filename.
rnto	Disallows the command that specifies rename-to filename.
site	Disallows the command that are specific to the server system. Usually used for remote administration.
stou	Disallows the command that stores a file using a unique file name.

The following complete example shows how to identify FTP traffic, define a FTP map, define a policy, and apply the policy to the outside interface.

Example 21-3 Enabling and Configuring Strict FTP Inspection

```
hostname(config)# class-map ftp_port
hostname(config-cmap)# match port tcp eq 21
hostname(config-cmap)# exit
hostname(config)# ftp-map inbound_ftp
hostname(config-ftp-map)# request-command deny put stou appe
hostname(config-ftp-map)# exit
hostname(config)# policy-map sample_policy
hostname(config-pmap)# class ftp_port
hostname(config-pmap-c)# inspect ftp strict inbound_ftp
hostname(config-pmap-c)# exit
hostname(config-pmap)# exit
hostname(config)# service-policy sample_policy interface outside
```

To enable FTP inspection for all interfaces, enter the **global** parameter in place of **interface outside**.

Verifying and Monitoring FTP Inspection

FTP application inspection generates the following log messages:

- An Audit record 302002 is generated for each file that is retrieved or uploaded.
- The **ftp** command is checked to see if it is RETR or STOR and the retrieve and store commands are logged.
- The username is obtained by looking up a table providing the IP address.

- The username, source IP address, destination IP address, NAT address, and the file operation are logged.
- Audit record 201005 is generated if the secondary dynamic channel preparation failed due to memory shortage.

In conjunction with NAT, the FTP application inspection translates the IP address within the application payload. This is described in detail in RFC 959.

Managing GTP Inspection

This section describes how the GTP inspection engine works and how you can change its configuration. This section includes the following topics:

- [GTP Inspection Overview, page 21-28](#)
- [Enabling and Configuring GTP Inspection, page 21-29](#)
- [Enabling and Configuring GSN Pooling, page 21-32](#)
- [Verifying and Monitoring GTP Inspection, page 21-34](#)



Note

GTP inspection requires a special license. If you enter GTP-related commands on a security appliance without the required license, the security appliance displays an error message.

GTP Inspection Overview

GPRS provides uninterrupted connectivity for mobile subscribers between GSM networks and corporate networks or the Internet. The GGSN is the interface between the GPRS wireless data network and other networks. The SGSN performs mobility, data session management, and data compression (See [Figure 21-4](#)).

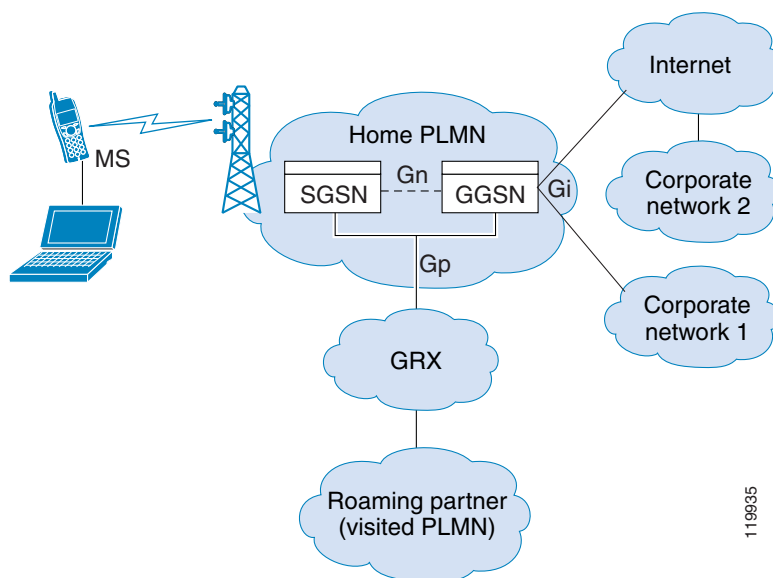
Figure 21-4 GPRS Tunneling Protocol



The UMTS is the commercial convergence of fixed-line telephony, mobile, Internet and computer technology. UTRAN is the networking protocol used for implementing wireless networks in this system. GTP allows multi-protocol packets to be tunneled through a UMTS/GPRS backbone between a GGSN, an SGSN and the UTRAN.

GTP does not include any inherent security or encryption of user data, but using GTP with the security appliance helps protect your network against these risks.

The SGSN is logically connected to a GGSN using GTP. GTP allows multiprotocol packets to be tunneled through the GPRS backbone between GSNs. GTP provides a tunnel control and management protocol that allows the SGSN to provide GPRS network access for a mobile station by creating, modifying, and deleting tunnels. GTP uses a tunneling mechanism to provide a service for carrying user data packets.

**Note**

When using GTP with failover, if a GTP connection is established and the active unit fails before data is transmitted over the tunnel, the GTP data connection (with a “j” flag set) is not replicated to the standby unit. This occurs because the active unit does not replicate embryonic connections to the standby unit.

Enabling and Configuring GTP Inspection

GTP application inspection is disabled by default, so you need to complete the procedures described in this section to enable GTP inspection.

**Note**

GTP inspection requires a special license. If you enter GTP-related commands on a security appliance without the required license, the security appliance displays an error message.

To enable or change GTP configuration, perform the following steps:

- Step 1** Define access control lists to identify the two ports required for receiving GTP traffic. For example, the following commands identify the default ports for GTP inspection.

```
hostname(config)# access-list gtp_acl permit udp any any eq 3386
hostname(config)# access-list gtp_acl permit udp any any eq 2123
```

- Step 2** Name the traffic class by entering the following command in global configuration mode:

```
hostname(config)# class-map class_map_name
```

Replace *class_map_name* with the name of the traffic class, for example:

```
hostname(config)# class-map gtp_port
```

When you enter the **class-map** command, the CLI enters the class map configuration mode, and the prompt changes, as in the following example:

```
hostname(config-cmap)#
```

- Step 3** In the class map configuration mode, define the **match** command, as in the following example:

```
hostname(config-cmap)# match access-list gtp_acl
hostname(config-cmap)# exit
hostname(config)#
```

- Step 4** (Optional) Create a GTP map by entering the following command:

```
hostname(config)# gtp-map gtp_map_name
```

Replace *gtp_map_name* with the name of the GTP map, for example:

```
hostname(config)# gtp-map inbound_gtp
```

This map is automatically enabled when you enable GTP without specifying a GTP map.

The system enters GTP map configuration mode and the CLI prompt changes as in the following example:

```
hostname(config-gtp)# gtp-map inbound_gtp
hostname(config-gtp-map)#
```

- Step 5** (Optional) Change the default configuration as required by entering any of the supported GTP map configuration commands, summarized in [Table 21-3](#).

The default GTP map is used when you enable GTP without specifying a GTP map. This default GTP map is preconfigured with the following default values:

- **timeout tunnel** 0:01:00
- **request-queue** 200
- **timeout gsn** 0:30:00
- **timeout pdp-context** 0:30:00
- **timeout request** 0:01:00
- **timeout signaling** 0:30:00
- **tunnel-limit** 500

- Step 6** Name the policy map by entering the following command:

```
hostname(config-gtp-map)# exit
hostname(config)# policy-map policy_map_name
```

Replace *policy_map_name* with the name of the policy map, as in the following example:

```
hostname(config)# policy-map sample_policy
```

The CLI enters the policy map configuration mode and the prompt changes accordingly, as follows:

```
hostname(config-pmap)#
```

- Step 7** Specify the traffic class defined in [Step 2](#) to be included in the policy map by entering the following command:

```
hostname(config-pmap)# class class_map_name
```

For example, the following command assigns the *gtp_port* traffic class to the current policy map:

```
hostname(config-pmap)# class gtp_port
```

The CLI enters the policy map class configuration mode and the prompt changes accordingly, as follows:

```
hostname(config-pmap-c)#
```

- Step 8** To enable GTP application inspection using a GTP map, enter the following command:

```
hostname(config-pmap-c)# inspect gtp [gtp_map_name]
```

The default GTP map is used when you enable GTP without specifying a GTP map. To use a different GTP map, replace *gtp_map_name* with the GTP map that you want to use. For example, the following command causes the security appliance to use the GTP map created in the previous steps.

```
hostname(config-pmap-c)# inspect gtp inbound_gtp
```

- Step 9** Return to policy map configuration mode by entering the following command:

```
hostname(config-pmap-c)# exit
hostname(config-pmap)#
```

- Step 10** Return to global configuration mode by entering the following command:

```
hostname(config-pmap) # exit
hostname(config) #
```

Step 11 Apply the policy map globally or to a specific interface by entering the following command:

```
hostname(config) # service-policy policy_map_name [global | interface interface_ID
```

Replace `policy_map_name` with the policy map you configured in [Step 6](#), and identify all the interfaces with the **global** option or a specific interface using the name assigned with the **nameif** command.

For example, the following command applies the `sample_policy` to the outside interface:

```
hostname(config) # service-policy sample_policy interface outside
```

The following command applies the `sample_policy` to the all the security appliance interfaces:

```
hostname(config) # service-policy sample_policy global
```

The following example shows how to use access lists to identify GTP traffic, define a GTP map, define a policy, and apply the policy to the outside interface.

Example 21-4 Enabling and Configuring GTP Inspection

```
hostname(config) # access-list gtp_acl permit udp any any eq 3386
hostname(config) # access-list gtp_acl permit udp any any eq 2123
hostname(config) # class-map gtp-traffic
hostname(config-cmap) # match access-list gtp_acl
hostname(config-cmap) # exit
hostname(config) # gtp-map inbound_gtp
hostname(config-gtp-map) # request-queue 300
hostname(config-gtp-map) # mcc 111 mnc 222
hostname(config-gtp-map) # message-length min 20 max 300
hostname(config-gtp-map) # drop message 20
hostname(config-gtp-map) # tunnel-limit 10000
hostname(config) # policy-map sample_policy
hostname(config-pmap) # class gtp-traffic
hostname(config-pmap-c) # inspect gtp inbound_gtp
hostname(config) # service-policy sample_policy outside
```

[Table 21-4](#) summarizes the configuration commands available in GTP map configuration mode. Refer to the command page in the *Cisco Security Appliance Command Reference* for the detailed syntax of each command.

Table 21-4 GTP Map Configuration Commands

Command	Description
description	Specifies the GTP configuration map description.
drop	Specifies the message ID, APN, or GTP version to drop.
help	Displays help for GTP map configuration commands.
mcc	Specifies the three-digit mobile country code (000 - 999) and the two or three-digit mobile network code. One or two-digit entries are prepended with 0s.
message-length	Specifies the message length min and max values.
permit errors	Permits packets with errors or different GTP versions.

Table 21-4 GTP Map Configuration Commands (continued)

Command	Description
permit response	Permits GSN load balancing. For more information, see Enabling and Configuring GSN Pooling, page 21-32 .
request-queue	Specifies the maximum requests allowed in the queue.
timeout	Specifies the idle timeout for the GSN, PDP context, requests, signaling connections, and tunnels.
tunnel-limit	Specifies the maximum number of tunnels allowed.

**Note**

The actions that you can specify for messages that fail the criteria set using the different configuration commands include **allow**, **reset**, or **drop**. In addition to these actions, you can specify to log the event or not.

Enabling and Configuring GSN Pooling

If the security appliance performs GTP inspection, by default the security appliance drops GTP responses from GSNs that were not specified in the GTP request. This situation occurs when you use load-balancing among a pool of GSNs to provide efficiency and scalability of GPRS.

You can enable support for GSN pooling by using the **permit response** command. This command configures the security appliance to allow responses from any of a designated set of GSNs, regardless of the GSN to which a GTP request was sent. You identify the pool of load-balancing GSNs as a network object. Likewise, you identify the SGSN as a network object. If the GSN responding belongs to the same object group as the GSN that the GTP request was sent to and if the SGSN is in a object group that the responding GSN is permitted to send a GTP response to, the security appliance permits the response. You add the **permit response** command to a GTP map configuration, which in turn is specified by the **inspect gtp** command.

The following procedure provides steps for adding support for GSN pooling to an existing GTP inspection configuration. For more information about configuring GTP inspection, see “[Enabling and Configuring GTP Inspection](#)” section on page 21-29.

To enable GSN pooling for an existing GTP inspection configuration, perform the following steps:

Step 1 Create an object to represent the pool of load-balancing GSNs. To do so, perform the following steps:

- a. Use the **object-group** command to define a new network object group representing the pool of load-balancing GSNs.

```
hostname(config)# object-group network GSN-pool-name
hostname(config-network)#
```

For example, the following command creates an object group named gsnpool32:

```
hostname(config)# object-group network gsnpool32
hostname(config-network)#
```

- b. Use the **network-object** command to specify the load-balancing GSNs. You can do so with one **network-object** command per GSN, using the **host** keyword. You can also using **network-object** command to identify whole networks containing GSNs that perform load balancing.

```
hostname(config-network)# network-object host IP-address
```

For example, the following commands create three network objects representing individual hosts:

```
hostname(config-network)# network-object host 192.168.100.1
hostname(config-network)# network-object host 192.168.100.2
hostname(config-network)# network-object host 192.168.100.3
hostname(config-network)#
```

- c. Exit Network configuration mode.

```
hostname(config-network)# exit
hostname(config)#
```

Step 2 Create an object to represent the SGSN that the load-balancing GSNs are permitted to respond to. To do so, perform the following steps:

- a. Use the **object-group** command to define a new network object group that will represent the SGSN that sends GTP requests to the GSN pool.

```
hostname(config)# object-group network SGSN-name
hostname(config-network)#
```

For example, the following command creates an object group named sgsn32:

```
hostname(config)# object-group network sgsn32
hostname(config-network)#
```

- b. Use the **network-object** command with the **host** keyword to identify the SGSN.

```
hostname(config-network)# network-object host IP-address
```

For example, the following command creates a network objects representing the SGSN:

```
hostname(config-network)# network-object host 192.168.50.100
hostname(config-network)#
```

- c. Exit Network configuration mode.

```
hostname(config-network)# exit
hostname(config)#
```

Step 3 Enter GTP map configuration mode for the GTP map to which you want to add GSN pooling support.

```
hostname(config)# gtp-map GTP-map-name
hostname(config-gtp-map)#
```

For example, the following command enters GTP map configuration mode for the GTP map named gtp-policy:

```
hostname(config)# gtp-map gtp-policy
```

Step 4 Use the **permit response** command to allow GTP responses from any GSN in the network object representing the GSN pool, defined in [Step 1](#), to the network object representing the SGSN, defined in [Step 2](#).

```
hostname(config-gtp-map)# permit response to-object-group SGSN-name from-object-group GSN-pool-name
```

For example, the following command permits GTP responses from any host in the object group named gsnpool32 to the host in the object group named sgsn32:

```
hostname(config-gtp-map)# permit response to-object-group sgsn32 from-object-group gsnpool32
```

Example 21-5 shows how to support GSN pooling by defining network objects for the GSN pool and the SGSN. An entire Class C network is defined as the GSN pool but you can identify multiple individual IP addresses, one per **network-object** command, instead of identifying whole networks. The example then modifies a GTP map to permit responses from the GSN pool to the SGSN.

Example 21-5 Enabling GSN Pooling

```
hostname(config)# object-group network gsnpool32
hostname(config-network)# network-object 192.168.100.0 255.255.255.0
hostname(config)# object-group network sgsn32
hostname(config-network)# network-object host 192.168.50.100
hostname(config-network)# exit
hostname(config)# gtp-map gtp-policy
hostname(config-gtp-map)# permit response to-object-group sgsn32 from-object-group
gsnpool32
```

Verifying and Monitoring GTP Inspection

To display GTP configuration, enter the **show service-policy inspect gtp** command in privileged EXEC mode. For the detailed syntax for this command, see the command page in the *Cisco Security Appliance Command Reference*.

Use the **show service-policy inspect gtp statistics** command to show the statistics for GTP inspection. The following is sample output from the **show service-policy inspect gtp statistics** command:

```
hostname# show service-policy inspect gtp statistics
GPRS GTP Statistics:
  version_not_support          0      msg_too_short          0
  unknown_msg                 0      unexpected_sig_msg     0
  unexpected_data_msg         0      ie_duplicated          0
  mandatory_ie_missing        0      mandatory_ie_incorrect 0
  optional_ie_incorrect       0      ie_unknown             0
  ie_out_of_order             0      ie_unexpected          0
  total_forwarded             0      total_dropped          0
  signalling_msg_dropped      0      data_msg_dropped       0
  signalling_msg_forwarded    0      data_msg_forwarded     0
  total_created_pdp           0      total_deleted_pdp      0
  total_created_pdpmcb        0      total_deleted_pdpmcb   0
  pdp_non_existent            0
```

You can use the vertical bar (|) to filter the display. Type ?| for more display filtering options.

Use the **show service-policy inspect gtp pdp-context** command to display PDP context-related information. The following is sample output from the **show service-policy inspect gtp pdp-context** command:

```
hostname# show service-policy inspect gtp pdp-context detail
1 in use, 1 most used, timeout 0:00:00

Version TID                MS Addr      SGSN Addr    Idle        APN
v1      1234567890123425      10.0.1.1    10.0.0.2   0:00:13    gprs.cisco.com

  user_name (IMSI): 214365870921435    MS address:      1.1.1.1
  primary pdp: Y                          nsapi: 2
  sgsn_addr_signal:      10.0.0.2      sgsn_addr_data:      10.0.0.2
  ggsn_addr_signal:      10.1.1.1      ggsn_addr_data:      10.1.1.1
  sgsn control teid:     0x000001d1    sgsn data teid:      0x000001d3
  ggsn control teid:     0x6306ffa0    ggsn data teid:      0x6305f9fc
  seq_tpdu_up:           0                      seq_tpdu_down:      0
```

```

signal_sequence:                0
upstream_signal_flow:           0    upstream_data_flow:           0
downstream_signal_flow:         0    downstream_data_flow:         0
RAupdate_flow:                  0

```

The PDP context is identified by the tunnel ID, which is a combination of the values for IMSI and NSAPI. A GTP tunnel is defined by two associated PDP contexts in different GSN nodes and is identified with a Tunnel ID. A GTP tunnel is necessary to forward packets between an external packet data network and a MS user.

You can use the vertical bar (|) to filter the display, as in the following example:

```
hostname# show service-policy gtp statistics | grep gsn
```

Managing H.323 Inspection

This section describes how to enable H.323 application inspection and change the default port configuration. This section includes the following topics:

- [H.323 Inspection Overview, page 21-35](#)
- [How H.323 Works, page 21-35](#)
- [Limitations and Restrictions, page 21-37](#)
- [Enabling and Configuring H.323 Inspection, page 21-37](#)
- [Configuring H.225 Timeout Values, page 21-39](#)
- [Verifying and Monitoring H.323 Inspection, page 21-39](#)

H.323 Inspection Overview

The **inspect h323** command provides support for H.323 compliant applications such as Cisco CallManager and VocalTec Gatekeeper. H.323 is a suite of protocols defined by the International Telecommunication Union for multimedia conferences over LANs. The security appliance supports H.323 through Version 4, including H.323 v3 feature Multiple Calls on One Call Signaling Channel.

With H323 inspection enabled, the security appliance supports multiple calls on the same call signaling channel, a feature introduced with H.323 Version 3. This feature reduces call setup time and reduces the use of ports on the security appliance.

The two major functions of H.323 inspection are as follows:

- NAT the necessary embedded IPv4 addresses in the H.225 and H.245 messages. Because H.323 messages are encoded in PER encoding format, the security appliance uses an ASN.1 decoder to decode the H.323 messages.
- Dynamically allocate the negotiated H.245 and RTP/RTCP connections.

How H.323 Works

The H.323 collection of protocols collectively may use up to two TCP connection and four to six UDP connections. FastConnect uses only one TCP connection, and RAS uses a single UDP connection for registration, admissions, and status.

An H.323 client may initially establish a TCP connection to an H.323 server using TCP port 1720 to request Q.931 call setup. As part of the call setup process, the H.323 terminal supplies a port number to the client to use for an H.245 TCP connection. In environments where H.323 gatekeeper is in use, the initial packet is transmitted using UDP.

H.323 inspection monitors the Q.931 TCP connection to determine the H.245 port number. If the H.323 terminals are not using FastConnect, the security appliance dynamically allocates the H.245 connection based on the inspection of the H.225 messages.

Within each H.245 message, the H.323 endpoints exchange port numbers that are used for subsequent UDP data streams. H.323 inspection inspects the H.245 messages to identify these ports and dynamically creates connections for the media exchange. RTP uses the negotiated port number, while RTCP uses the next higher port number.

The H.323 control channel handles H.225 and H.245 and H.323 RAS. H.323 inspection uses the following ports.

- 1718—Gate Keeper Discovery UDP port
- 1719—RAS UDP port
- 1720—TCP Control Port

You must open an access list for the well-known H.323 port 1720 for the H.225 call signaling. However, the H.245 signaling ports are negotiated between the endpoints in the H.225 signaling. When an H.323 gatekeeper is used, the security appliance opens an H.225 connection based on inspection of the ACF message.

The security appliance dynamically allocates the H.245 channel after inspecting the H.225 messages and then links to the H.245 channel to be fixed up as well. That means whatever H.245 messages pass through the security appliance pass through the H.245 application inspection, NATing embedded IP addresses and opening the negotiated media channels.

The H.323 ITU standard requires that a TPKT header, defining the length of the message, precede the H.225 and H.245, before being passed on to the reliable connection. Because the TPKT header does not necessarily need to be sent in the same TCP packet as the H.225/H.245 message, the security appliance must remember the TPKT length to process/decode the messages properly. The security appliance keeps a data structure for each connection and that data structure contains the TPKT length for the next expected message.

If the security appliance needs to NAT any IP addresses, then it changes the checksum, the UUIE length, and the TPKT, if included in the TCP packet with the H.225 message. If the TPKT is sent in a separate TCP packet, then the security appliance proxy ACKs that TPKT and appends a new TPKT to the H.245 message with the new length.

**Note**

The security appliance does not support TCP options in the Proxy ACK for the TPKT.

Each UDP connection with a packet going through H.323 inspection is marked as an H.323 connection and times out with the H.323 timeout as configured with the **timeout** command.

Limitations and Restrictions

The following are some of the known issues and limitations when using H.323 application inspection:

- Static PAT may not properly translate IP addresses embedded in optional fields within H.323 messages. If you experience this kind of problem, do not use static PAT with H.323.
- It has been observed that when a NetMeeting client registers with an H.323 gatekeeper and tries to call an H.323 gateway that is also registered with the H.323 gatekeeper, the connection is established but no voice is heard in either direction. This problem is unrelated to the security appliance.
- If you configure a network static address where the network static address is the same as a third-party netmask and address, then any outbound H.323 connection fails.

Enabling and Configuring H.323 Inspection

To enable H.323 inspection or change the default port used for receiving H.323 traffic, perform the following steps:

- Step 1** Define access control lists to identify the two ports required for receiving H.323 traffic. For example, the following commands identify the default ports for H.323 inspection.

```
hostname(config)# access-list h323_acl permit udp any any eq 1720
hostname(config)# access-list h323_acl permit udp any any eq 1721
```

- Step 2** Name the traffic class by entering the following command in global configuration mode:

```
hostname(config)# class-map class_map_name
```

Replace *class_map_name* with the name of the traffic class, for example:

```
hostname(config)# class-map h323_port
```

When you enter the **class-map** command, the CLI enters the class map configuration mode, and the prompt changes, as in the following example:

```
hostname(config-cmap)#
```

In the class map configuration mode, define the **match** command, as in the following example:

```
hostname(config-cmap)# match access-list h323_acl
hostname(config-cmap)# exit
hostname(config)#
```

To assign a range of continuous ports, enter the **range** keyword, as in the following example:

```
hostname(config-cmap)# match port tcp range 1718-1720
```

To assign more than one non-contiguous port for H323 inspection, enter the **access-list** command and define an access control entry to match each port. Then enter the **match** command to associate the access lists with the H323 traffic class.

- Step 3** Name the policy map by entering the following command:

```
hostname(config)# policy-map policy_map_name
```

Replace *policy_map_name* with the name of the policy map, as in the following example:

```
hostname(config)# policy-map sample_policy
```

The CLI enters the policy map configuration mode and the prompt changes accordingly, as follows:

```
hostname(config-pmap)#
```

- Step 4** Specify the traffic class defined in [Step 2](#) to be included in the policy map by entering the following command:

```
hostname(config-pmap)# class class_map_name
```

For example, the following command assigns the h323_port traffic class to the current policy map.

```
hostname(config-pmap)# class h323_port
```

The CLI enters the policy map class configuration mode and the prompt changes accordingly, as follows:

```
hostname(config-pmap-c)#
```

- Step 5** To enable H.323 traffic inspection, enter the following commands:

```
hostname(config-pmap-c)# inspect h323 ras
hostname(config-pmap-c)# inspect h323 h225
```

Return to policy map configuration mode by entering the following command:

```
hostname(config-pmap-c)# exit
hostname(config-pmap)#
```

- Step 6** Return to global configuration mode by entering the following command:

```
hostname(config-pmap)# exit
hostname(config)#
```

- Step 7** Apply the policy map globally or to a specific interface by entering the following command:

```
hostname(config)# service-policy policy_map_name [global | interface interface_ID
```

Replace *policy_map_name* with the policy map you configured in [Step 3](#), and identify all the interfaces with the **global** option or a specific interface using the name assigned with the **nameif** command.

For example, the following command applies the sample_policy to the outside interface:

```
hostname(config)# service-policy sample_policy interface outside
```

The following command applies the sample_policy to all the security appliance interfaces:

```
hostname(config)# service-policy sample_policy global
```

Example 21-6 Enabling and Configuring H.323 Inspection

You enable the H.323 inspection engine as shown in the following example, which creates a class map to match H.323 traffic on the default port (1720). The service policy is then applied to the outside interface.

```
hostname(config)# access-list h323_acl permit udp any any eq 1720
hostname(config)# access-list h323_acl permit udp any any eq 1721
hostname(config)# class-map h323-traffic
hostname(config-cmap)# match access-list h323_acl
hostname(config-cmap)# exit
hostname(config)# policy-map sample_policy
hostname(config-pmap)# class h323_port
hostname(config-pmap-c)# inspect h323 ras
```

```
hostname(config-pmap-c)# inspect h323 h225
hostname(config-pmap-c)# exit
hostname(config)# service-policy sample_policy interface outside
```

To enable H.323 inspection for all interfaces, enter the **global** parameter in place of **interface outside**.

Configuring H.225 Timeout Values

To configure the idle time after which an H.225 signalling connection is closed, enter the following command:

```
hostname(config)# timeout h225
```

The default is 1:00:00.

To configure the idle time after which an H.323 control connection is closed, enter the following command:

```
hostname(config)# timeout h323
```

The default is 0:05:00.

Verifying and Monitoring H.323 Inspection

This section describes how to display information about H.323 sessions. This section includes the following topics:

- [Monitoring H.225 Sessions, page 21-39](#)
- [Monitoring H.245 Sessions, page 21-40](#)
- [Monitoring H.323 RAS Sessions, page 21-40](#)

Monitoring H.225 Sessions

The **show h225** command displays information for H.225 sessions established across the security appliance. Along with the **debug h323 h225 event**, **debug h323 h245 event**, and **show local-host** commands, this command is used for troubleshooting H.323 inspection engine issues.

Before entering the **show h225**, **show h245**, or **show h323-ras** commands, we recommend that you configure the **pager** command. If there are a lot of session records and the **pager** command is not configured, it may take a while for the **show** command output to reach its end. If there is an abnormally large number of connections, check that the sessions are timing out based on the default timeout values or the values set by you. If they are not, then there is a problem that needs to be investigated.

The following is sample output from the **show h225** command:

```
hostname# show h225
Total H.323 Calls: 1
1 Concurrent Call(s) for
  Local: 10.130.56.3/1040 Foreign: 172.30.254.203/1720
  1. CRV 9861
  Local: 10.130.56.3/1040 Foreign: 172.30.254.203/1720
0 Concurrent Call(s) for
  Local: 10.130.56.4/1050 Foreign: 172.30.254.205/1720
```

This output indicates that there is currently 1 active H.323 call going through the security appliance between the local endpoint 10.130.56.3 and foreign host 172.30.254.203, and for these particular endpoints, there is 1 concurrent call between them, with a CRV for that call of 9861.

For the local endpoint 10.130.56.4 and foreign host 172.30.254.205, there are 0 concurrent calls. This means that there is no active call between the endpoints even though the H.225 session still exists. This could happen if, at the time of the **show h225** command, the call has already ended but the H.225 session has not yet been deleted. Alternately, it could mean that the two endpoints still have a TCP connection opened between them because they set “maintainConnection” to TRUE, so the session is kept open until they set it to FALSE again, or until the session times out based on the H.225 timeout value in your configuration.

Monitoring H.245 Sessions

The **show h245** command displays information for H.245 sessions established across the security appliance by endpoints using slow start. Slow start is when the two endpoints of a call open another TCP control channel for H.245. Fast start is where the H.245 messages are exchanged as part of the H.225 messages on the H.225 control channel.) Along with the **debug h323 h245 event**, **debug h323 h225 event**, and **show local-host** commands, this command is used for troubleshooting H.323 inspection engine issues.

The following is sample output from the **show h245** command:

```
hostname# show h245
Total: 1
      LOCAL          TPKT    FOREIGN          TPKT
1     10.130.56.3/1041      0      172.30.254.203/1245    0
      MEDIA: LCN 258 Foreign 172.30.254.203 RTP 49608 RTCP 49609
              Local   10.130.56.3 RTP 49608 RTCP 49609
      MEDIA: LCN 259 Foreign 172.30.254.203 RTP 49606 RTCP 49607
              Local   10.130.56.3 RTP 49606 RTCP 49607
```

There is currently one H.245 control session active across the security appliance. The local endpoint is 10.130.56.3, and we are expecting the next packet from this endpoint to have a TPKT header because the TPKT value is 0. The TKTP header is a 4-byte header preceding each H.225/H.245 message. It gives the length of the message, including the 4-byte header. The foreign host endpoint is 172.30.254.203, and we are expecting the next packet from this endpoint to have a TPKT header because the TPKT value is 0.

The media negotiated between these endpoints have an LCN of 258 with the foreign RTP IP address/port pair of 172.30.254.203/49608 and an RTCP IP address/port of 172.30.254.203/49609 with a local RTP IP address/port pair of 10.130.56.3/49608 and an RTCP port of 49609.

The second LCN of 259 has a foreign RTP IP address/port pair of 172.30.254.203/49606 and an RTCP IP address/port pair of 172.30.254.203/49607 with a local RTP IP address/port pair of 10.130.56.3/49606 and RTCP port of 49607.

Monitoring H.323 RAS Sessions

The **show h323-ras** command displays information for H.323 RAS sessions established across the security appliance between a gatekeeper and its H.323 endpoint. Along with the **debug h323 ras event** and **show local-host** commands, this command is used for troubleshooting H.323 RAS inspection engine issues.

The **show h323-ras** command displays connection information for troubleshooting H.323 inspection engine issues. The following is sample output from the **show h323-ras** command:

```
hostname# show h323-ras
Total: 1
      GK                               Caller
      172.30.254.214 10.130.56.14
```

This output shows that there is one active registration between the gatekeeper 172.30.254.214 and its client 10.130.56.14.

Managing HTTP Inspection

This section describes how the HTTP inspection engine works and how you can change its configuration. This section includes the following topics:

- [HTTP Inspection Overview, page 21-41](#)
- [Enabling and Configuring Advanced HTTP Inspection, page 21-42](#)

HTTP Inspection Overview

Use the **inspect http** command to protect against specific attacks and other threats that may be associated with HTTP traffic. HTTP inspection performs several functions:

- Enhanced HTTP inspection
- URL screening through N2H2 or Websense
- Java and ActiveX filtering

The latter two features are configured in conjunction with the **filter** command. See the “[Applying Filtering](#)” chapter.



Note

The **no inspect http** command also disables the **filter url** command.

The enhanced HTTP inspection feature, which is also known as an application firewall, verifies that HTTP messages conform to RFC 2616, use RFC-defined methods, and comply with various other criteria. This can help prevent attackers from using HTTP messages for circumventing network security policy. In many cases, you can configure these criteria and the way the system responds when these criteria are not met. The actions that you can specify for messages that fail the criteria set using the different configuration commands include **allow**, **reset**, or **drop**. In addition to these actions, you can specify to log the event or not.

The criteria that you can apply to HTTP messages include the following:

- Does not include any method on a configurable list.
- Specific transfer encoding method or application type.
- HTTP transaction adheres to RFC specification.
- Message body size is within configurable limits.
- Request and response message header size is within a configurable limit.
- URI length is within a configurable limit.
- The content-type in the message body matches the header.

- The content-type in the response message matches the *accept-type* field in the request message.
- MIME type is included on a predefined list.
- Specified keywords are present or absent at specified positions in the message.

To enable enhanced HTTP inspection, enter the **inspect http** *http-map* command. The rules that this applies to HTTP traffic are defined by the specific HTTP map, which you configure by entering the **http-map** command and HTTP map configuration mode commands.

**Note**

When you enable HTTP inspection with an HTTP map, strict HTTP inspection with the action reset and log is enabled by default. You can change the actions performed in response to inspection failure, but you cannot disable strict inspection as long as the HTTP map remains enabled.

Enabling and Configuring Advanced HTTP Inspection

Use the procedures in this section to change the default HTTP configuration, in any of the following ways:

- Enable enhanced HTTP inspection (application firewall)
- Change the default configuration for enhanced HTTP inspection
- Change the default port number

To enable or configure enhanced HTTP inspection, perform the following steps:

Step 1 Name the traffic class by entering the following command in global configuration mode:

```
hostname(config)# class-map class_map_name
```

Replace *class_map_name* with the name of the traffic class, for example:

```
hostname(config)# class-map http_port
```

When you enter the **class-map** command, the CLI enters the class map configuration mode, and the prompt changes, as in the following example:

```
hostname(config-cmap)#
```

Step 2 In the class map configuration mode, define the **match** command, as in the following example:

```
hostname(config-cmap)# match port tcp eq 80
hostname(config-cmap)# exit
hostname(config)#
```

To assign a range of continuous ports, enter the **range** keyword, as in the following example:

```
hostname(config-cmap)# match port tcp range 1080-1090
```

To assign more than one non-contiguous port for HTTP inspection, enter the **access-list** command and define an access control entry to match each port. Then enter the **match** command to associate the access lists with the HTTP traffic class.

Step 3 Create an HTTP map by entering the following command:

```
hostname(config)# http-map http_map_name
```

Replace *http_map_name* with the name of the HTTP map, for example:

```
hostname(config)# http-map inbound_http
```

The system enters HTTP map configuration mode and the CLI prompt changes as in the following example:

```
hostname(config-http-map)#
```

Step 4 Change the default configuration as required by entering any of the supported HTTP map configuration commands, summarized in [Table 21-5](#).

Step 5 Return to global configuration mode by entering the following command:

```
hostname(config-http-map)# exit  
hostname(config)#
```

Step 6 Name the policy map by entering the following command:

```
hostname(config)# policy-map policy_map_name
```

Replace *policy_map_name* with the name of the policy map, as in the following example:

```
hostname(config)# policy-map sample_policy
```

The CLI enters the policy map configuration mode and the prompt changes accordingly, as follows:

```
hostname(config-pmap)#
```

Step 7 Specify the traffic class defined in [Step 1](#) to be included in the policy map by entering the following command:

```
hostname(config-pmap)# class class_map_name
```

For example, the following command assigns the `http_port` traffic class to the current policy map.

```
hostname(config-pmap)# class http_port
```

The CLI enters the policy map class configuration mode and the prompt changes accordingly, as follows:

```
hostname(config-pmap-c)#
```

Step 8 To apply strict inspection to the traffic that matches the criteria defined in the traffic class, enter the following command:

```
hostname(config-pmap-c)# inspect http inbound_http
```

Step 9 Return to policy map configuration mode by entering the following command:

```
hostname(config-pmap-c)# exit  
hostname(config-pmap)#
```

Step 10 Return to global configuration mode by entering the following command:

```
hostname(config-pmap)# exit  
hostname(config)#
```

Step 11 Apply the policy map globally or to a specific interface by entering the following command:

```
hostname(config)# service-policy policy_map_name [global | interface interface_ID]
```

Replace *policy_map_name* with the policy map you configured in [Step 6](#), and identify all the interfaces with the **global** option or a specific interface using the name assigned with the **nameif** command.

For example, the following command applies the `sample_policy` to the outside interface:

```
hostname(config)# service-policy sample_policy interface outside
```

The following command applies the `sample_policy` to the all the security appliance interfaces:

```
hostname(config)# service-policy sample_policy global
```

Example 21-7 Enabling and Configuring Enhanced HTTP Inspection

The following example shows how to use access lists to identify HTTP traffic, define an HTTP map, define a policy, and apply the policy to the outside interface:

```
hostname(config)# class-map http_port
hostname(config-cmap)# match port tcp eq 80
hostname(config-cmap)# exit
hostname(config)# http-map inbound_http
hostname(config-http-map)# content-length min 100 max 2000 action reset log
hostname(config-http-map)# content-type-verification match-req-rsp reset log
hostname(config-http-map)# max-header-length request bytes 100 action log reset
hostname(config-http-map)# max-uri-length 100 action reset log
hostname(config-http-map)# exit
hostname(config)# policy-map sample_policy
hostname(config-pmap)# class http_port
hostname(config-pmap-c)# inspect http inbound_http
hostname(config-pmap-c)# exit
hostname(config-pmap)# exit
hostname(config)# service-policy sample_policy interface outside
```

[Table 21-5](#) summarizes the configuration commands available in HTTP map configuration mode. Refer to the command page in the *Cisco Security Appliance Command Reference* for the detailed syntax of each command.

Table 21-5 HTTP Map Configuration Commands

Command	Description
content-length	Enables inspection based on the length of the HTTP content.
content-type-verification	Enables inspection based on the type of HTTP content.
max-header-length	Enables inspection based on the length of the HTTP header.
max-uri-length	Enables inspection based on the length of the URI.
no	Negates a command or sets a parameter to its default value.
port-misuse	Enables application firewall inspection.
request-method	Enables inspection based on the HTTP request method.
strict-http	Enables strict HTTP inspection.
transfer-encoding	Enables inspection based on the transfer encoding type.



Note

The actions that you can specify for messages that fail the criteria set using the different configuration commands include **allow**, **reset**, or **drop**. In addition to these actions, you can specify to log the event or not.

Managing IPSec Pass Through Inspection

This section describes how the HTTP inspection engine works and how you can change its configuration. This section includes the following topics:

- [IPSec Pass Through Inspection Overview, page 21-45](#)
- [Enabling and Configuring IPSec Pass Through Inspection, page 21-45](#)

IPSec Pass Through Inspection Overview

The IPSec Pass Through inspection engine lets the security appliance pass ESP (IP protocol 50) traffic that is formed between two hosts because of successful IKE (UDP port 500) negotiation without the requirement of specific ESP access lists.

The inspection engine works on IKE UDP port 500 to create the control flow. The **inspect ipsec-pass-thru** command is attached to an UDP flow as defined in the MPF framework. When an ESP packet between the two peers arrives at the device, or an UDP packet with either source or destination port equal to 500, the packet is sent to the inspect module.

The ESP traffic is permitted by the inspection engine with the configured idle timeout if there is an existing control flow and it is within the connection limit defined in the MPF framework. A new control flow is created for IKE UDP port 500 traffic with the configured UDP idle timeout if there isn't one, or it uses the existing flow.

To ensure that the packet arrives into the inspection engine, a hole is punched for all such traffic (ESP). This inspect is attached to the control flow. The control flow is present as long as there is at least one data flow (ESP) established, but the traffic always flows on the same connection. Since this IKE connection is kept open as long as data flows, a rekey would always succeed. The flows are created irrespective of NAT or no NAT.



Note

AH (IP protocol 51) is not supported. PAT is not supported.

Enabling and Configuring IPSec Pass Through Inspection

Inspect IPSec Pass Through is disabled by default. When enabled without using a parameter map, the inspection uses the default IPSec Pass Through parameter map, which allows only ESP traffic with unlimited connections and the default idle timeout of 10 minutes for the ESP connection.

The following example shows how to define an IPSec Pass Through map:

```
hostname(config)# access-list test-udp-acl extended permit udp any any eq 500

hostname(config)# class-map test-udp-class
hostname(config-cmap)# match access-list test-udp-acl

hostname(config)# policy-map test-udp-policy
hostname(config-pmap)# class test-udp-class
hostname(config-pmap-c)# inspect IPSec-pass-thru IPSec-map
```

This policy is applied on the interface that has the policy to permit UDP 500 traffic through initially. In this example it is the outside interface.

To verify that the inspection engine opens the ESP data flows for IPSec Pass Through based on the IKE control flow, use the **show conn** command:

```
hostname(config)# show conn
ESP out 192.168.51.25 in 192.168.52.50 idle 0:00:00 bytes 864
ESP out 192.168.51.25 in 192.168.52.50 idle 0:00:10 bytes 0
UDP out 192.168.51.25:500 in 192.168.52.50:500 idle 0:00:00 flags -
ESP out 192.168.51.25 in 192.168.52.50 idle 0:00:00 bytes 864
ESP out 0.0.0.0 in 0.0.0.0 idle 0:00:10 bytes 0
```

Managing MGCP Inspection

This section describes how to enable and configure MGCP application inspection and change the default port configuration. This section includes the following topics:

- [MGCP Inspection Overview, page 21-46](#)
- [Configuring MGCP Call Agents and Gateways, page 21-48](#)
- [Configuring and Enabling MGCP Inspection, page 21-48](#)
- [Configuring MGCP Timeout Values, page 21-51](#)
- [Verifying and Monitoring MGCP Inspection, page 21-51](#)

MGCP Inspection Overview

MGCP is a master/slave protocol used to control media gateways from external call control elements called media gateway controllers or call agents. A media gateway is typically a network element that provides conversion between the audio signals carried on telephone circuits and data packets carried over the Internet or over other packet networks. Using NAT and PAT with MGCP lets you support a large number of devices on an internal network with a limited set of external (global) addresses.

Examples of media gateways are:

- Trunking gateways, that interface between the telephone network and a Voice over IP network. Such gateways typically manage a large number of digital circuits.
- Residential gateways, that provide a traditional analog (RJ11) interface to a Voice over IP network. Examples of residential gateways include cable modem/cable set-top boxes, xDSL devices, broad-band wireless devices.
- Business gateways, that provide a traditional digital PBX interface or an integrated soft PBX interface to a Voice over IP network.

MGCP messages are transmitted over UDP. A response is sent back to the source address (IP address and UDP port number) of the command, but the response may not arrive from the same address as the command was sent to. This can happen when multiple call agents are being used in a failover configuration and the call agent that received the command has passed control to a backup call agent, which then sends the response. [Figure 21-5](#) illustrates how NAT can be used with MGCP.

Figure 21-5 Using NAT with MGCP

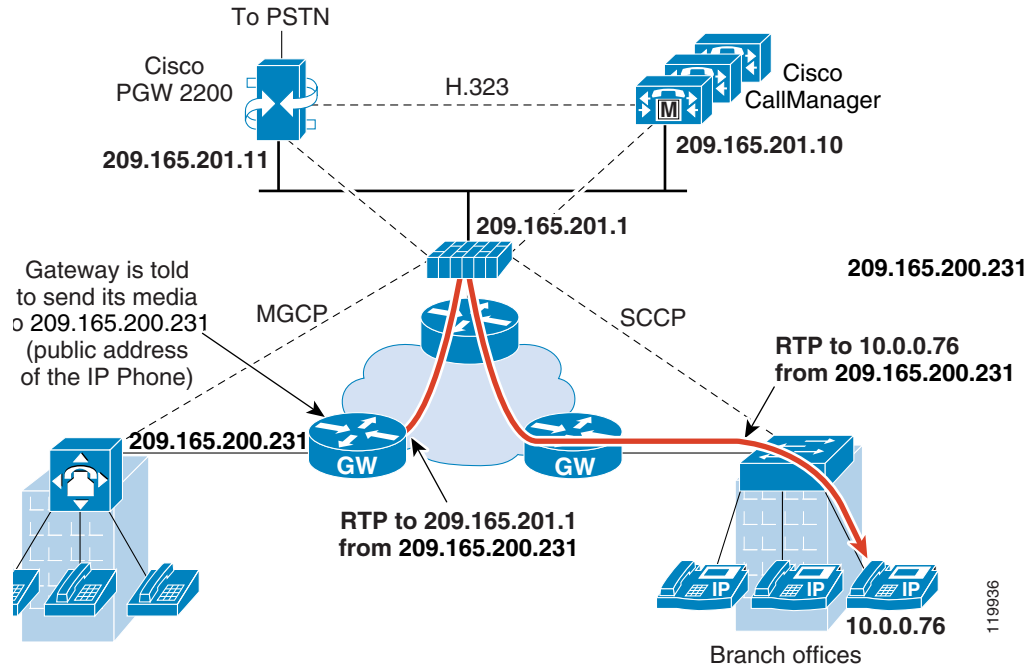

MGCP endpoints are physical or virtual sources and destinations for data. Media gateways contain endpoints on which the call agent can create, modify and delete connections to establish and control media sessions with other multimedia endpoints. Also, the call agent can instruct the endpoints to detect certain events and generate signals. The endpoints automatically communicate changes in service state to the call agent.

MGCP transactions are composed of a command and a mandatory response. There are eight types of commands:

- CreateConnection
- ModifyConnection
- DeleteConnection
- NotificationRequest
- Notify
- AuditEndpoint
- AuditConnection
- RestartInProgress

The first four commands are sent by the call agent to the gateway. The Notify command is sent by the gateway to the call agent. The gateway may also send a DeleteConnection. The registration of the MGCP gateway with the call agent is achieved by the RestartInProgress command. The AuditEndpoint and the AuditConnection commands are sent by the call agent to the gateway.

All commands are composed of a Command header, optionally followed by a session description. All responses are composed of a Response header, optionally followed by a session description.

To use MGCP, you usually need to configure at least two **inspect** commands: one for the port on which the gateway receives commands, and one for the port on which the call agent receives commands. Normally, a call agent sends commands to the default MGCP port for gateways (2427) while a gateway sends commands to the default MGCP port for call agents (2727).

Configuring MGCP Call Agents and Gateways

Use the **call-agent** command to specify a group of call agents that can manage one or more gateways. The call agent group information is used to open connections for the call agents in the group (other than the one a gateway sends a command to) so that any of the call agents can send the response. Call agents with the same *group_id* belong to the same group. A call agent may belong to more than one group. The *group_id* option is a number from 0 to 4294967295. The *ip_address* option specifies the IP address of the call agent.

To specify a group of call agents, enter the **call-agent** command in MGCP map configuration mode, which is accessible by entering the **mgcp-map** command. To remove the configuration, enter the **no** form of the command.

Use the **gateway** command to specify which group of call agents are managing a particular gateway. The IP address of the gateway is specified with the *ip_address* option. The *group_id* option is a number from 0 to 4294967295 that must correspond with the *group_id* of the call agents that are managing the gateway. A gateway may only belong to one group.



Note

MGCP call agents send AUEP messages to determine if MGCP end points are present. This establishes a flow through the security appliance and allows MGCP end points to register with the call agent.

Configuring and Enabling MGCP Inspection

Use the **mgcp-map** command to identify a specific map for defining the parameters for MGCP inspection. When you enter this command, the system enters a configuration mode that lets you enter the different commands used for defining the specific map. After defining the MGCP map, you enter the **inspect mgcp** command to enable the map. You use Modular Policy Framework to apply the **inspect** command to a defined class of traffic and to apply the policy to a specific interface.

To enable and configure MGCP application inspection, perform the following steps:

- Step 1** Define access control lists to identify the two ports required for receiving MGCP traffic. For example, the following commands identify the default ports for MGCP inspection.

```
hostname(config)# access-list mgcp_acl permit udp any any eq 2427
hostname(config)# access-list mgcp_acl permit udp any any eq 2727
hostname(config)# class-map mgcp-traffic
hostname(config-cmap)# match access-list mgcp_acl
```

Name the traffic class by entering the following command in global configuration mode:

```
hostname(config)# class-map class_map_name
```

Replace *class_map_name* with the name of the traffic class, for example:

```
hostname(config)# class-map mgcp_port
```

When you enter the **class-map** command, the CLI enters the class map configuration mode, and the prompt changes, as in the following example:

```
hostname(config-cmap)#
```

- Step 2** In the class map configuration mode, define the **match** command, as in the following example:

```
hostname(config-cmap)# match port udp eq 2427
hostname(config-cmap)# exit
hostname(config)#
```

Step 3 (Optional) Create a MGCP map by entering the following command:

```
hostname(config)# mgcp-map policy_map_name
```



Note An MGCP map is only required if the network has multiple call agents and gateways for which the firewall has to open pinholes.

Replace *mgcp_map_name* with the name of the MGCP map, for example:

```
hostname(config)# mgcp-map inbound_mgcp
```

The system enters MGCP map configuration mode and the CLI prompt changes as in the following example:

```
hostname(config-mgcp-map)#
```

Step 4 Configure the call agents, as in the following example:

```
hostname(config-mgcp-map)# call-agent 10.10.11.5 101
hostname(config-mgcp-map)# call-agent 10.10.11.6 101
hostname(config-mgcp-map)# call-agent 10.10.11.7 102
hostname(config-mgcp-map)# call-agent 10.10.11.8 102
```

Step 5 Configure the gateways, as in the following example:

```
hostname(config-mgcp-map)# gateway 10.10.10.115 101
hostname(config-mgcp-map)# gateway 10.10.10.116 102
hostname(config-mgcp-map)# gateway 10.10.10.117 102
```

Step 6 (Optional) To change the maximum number of commands allowed in the MGCP command queue, enter the following command:

```
hostname(config-mgcp-map)# command-queue command_limit
hostname(config-mgcp-map)# exit
hostname(config)#
```

Step 7 Name the policy map by entering the following command:

```
hostname(config)# policy-map policy_map_name
```

Replace *policy_map_name* with the name of the policy map, as in the following example:

```
hostname(config)# policy-map sample_policy
```

The CLI enters the policy map configuration mode and the prompt changes accordingly, as follows:

```
hostname(config-pmap)#
```

Step 8 Specify the traffic class defined in [Step 1](#) to be included in the policy map by entering the following command:

```
hostname(config-pmap)# class class_map_name
```

For example, the following command assigns the *mgcp_port* traffic class to the current policy map.

```
hostname(config-pmap)# class mgcp_port
```

The CLI enters the policy map class configuration mode and the prompt changes accordingly, as follows:

```
hostname(config-pmap-c)#
```

- Step 9** (Optional) To change the default port used by the security appliance for receiving MGCP traffic, enter the following command:

```
hostname(config-pmap-c)# inspect mgcp inbound_mgcp
```

If you are not using an MGCP map, enter the following command:

```
hostname(config-pmap-c)# inspect mgcp
```

- Step 10** Return to policy map configuration mode by entering the following command:

```
hostname(config-pmap-c)# exit
hostname(config-pmap)#
```

- Step 11** Return to global configuration mode by entering the following command:

```
hostname(config-pmap)# exit
hostname(config)#
```

- Step 12** Apply the policy map globally or to a specific interface by entering the following command:

```
hostname(config)# service-policy policy_map_name [global | interface interface_ID
```

Replace *policy_map_name* with the policy map you configured in [Step 7](#), and identify all the interfaces with the **global** option or a specific interface using the name assigned with the **nameif** command.

For example, the following command applies the *sample_policy* to the outside interface:

```
hostname(config)# service-policy sample_policy interface outside
```

The following command applies the *sample_policy* to the all the security appliance interfaces:

```
hostname(config)# service-policy sample_policy global
```

[Example 21-6](#) shows how to identify MGCP traffic, define a MGCP map, define a policy, and apply the policy to the outside interface. This creates a class map to match MGCP traffic on the default ports (2427 and 2727). The service policy is then applied to the outside interface.

Example 21-8 Enabling and Configuring MGCP Inspection

```
hostname(config)# access-list mgcp_acl permit udp any any eq 2427
hostname(config)# access-list mgcp_acl permit udp any any eq 2727
hostname(config)# class-map mgcp-traffic
hostname(config-cmap)# match access-list mgcp_acl
hostname(config-cmap)# exit
hostname(config)# mgcp-map inbound_mgcp
hostname(config-mgcp-map)# call-agent 10.10.11.5 101
hostname(config-mgcp-map)# call-agent 10.10.11.6 101
hostname(config-mgcp-map)# call-agent 10.10.11.7 102
hostname(config-mgcp-map)# call-agent 10.10.11.8 102
hostname(config-mgcp-map)# gateway 10.10.10.115 101
hostname(config-mgcp-map)# gateway 10.10.10.116 102
hostname(config-mgcp-map)# gateway 10.10.10.117 102
hostname(config-mgcp-map)# command-queue 150
hostname(config-mgcp-map)# exit
hostname(config)# policy-map sample_policy
hostname(config-pmap)# class mgcp_port
hostname(config-pmap-c)# inspect mgcp inbound_mgcp
hostname(config-pmap-c)# exit
hostname(config)# service-policy sample_policy interface outside
```

This configuration allows call agents 10.10.11.5 and 10.10.11.6 to control gateway 10.10.10.115, and allows call agents 10.10.11.7 and 10.10.11.8 to control both gateways 10.10.10.116 and 10.10.10.117. The maximum number of MGCP commands that can be queued is 150.

To enable MGCP inspection for all interfaces, enter the **global** parameter in place of **interface outside**.

Configuring MGCP Timeout Values

The **timeout mgcp** command lets you set the interval for inactivity after which an MGCP media connection is closed. The default is 5 minutes.

The **timeout mgcp-pat** command lets you set the timeout for PAT xlates. Because MGCP does not have a keepalive mechanism, if you use non-Cisco MGCP gateways (call agents), the PAT xlates are torn down after the default timeout interval, which is 30 seconds.

Verifying and Monitoring MGCP Inspection

The **show mgcp commands** command lists the number of MGCP commands in the command queue. The **show mgcp sessions** command lists the number of existing MGCP sessions. The **detail** option includes additional information about each command (or session) in the output. The following is sample output from the **show mgcp commands** command:

```
hostname# show mgcp commands
1 in use, 1 most used, 200 maximum allowed
CRCX, gateway IP: host-pc-2, transaction ID: 2052, idle: 0:00:07
```

The following is sample output from the **show mgcp detail** command.

```
hostname# show mgcp commands detail
1 in use, 1 most used, 200 maximum allowed
CRCX, idle: 0:00:10
  Gateway IP      host-pc-2
  Transaction ID  2052
  Endpoint name   aaln/1
  Call ID         9876543210abcdef
  Connection ID
  Media IP        192.168.5.7
  Media port      6058
```

The following is sample output from the **show mgcp sessions** command.

```
hostname# show mgcp sessions
1 in use, 1 most used
Gateway IP host-pc-2, connection ID 6789af54c9, active 0:00:11
```

The following is sample output from the **show mgcp sessions detail** command.

```
hostname# show mgcp sessions detail
1 in use, 1 most used
Session active 0:00:14
  Gateway IP      host-pc-2
  Call ID         9876543210abcdef
  Connection ID   6789af54c9
  Endpoint name   aaln/1
  Media lcl port  6166
  Media rmt IP    192.168.5.7
  Media rmt port  6058
```

Managing RTSP Inspection

This section describes how to enable RTSP application inspection and change the default port configuration. This section includes the following topics:

- [RTSP Inspection Overview, page 21-52](#)
- [Using RealPlayer, page 21-52](#)
- [Restrictions and Limitations, page 21-53](#)
- [Configuring RTSP Inspection, page 21-53](#)

RTSP Inspection Overview

To configure RTSP application inspection or to change the ports to which the security appliance listens, enter the **inspect rtsp** command in policy map class configuration mode, which is accessible by entering the **class** command within policy map configuration mode. To remove the configuration, enter the **no** form of the command. This command is enabled by default.

The **inspect rtsp** command lets the security appliance pass RTSP packets. RTSP is used by RealAudio, RealNetworks, Apple QuickTime 4, RealPlayer, and Cisco IP/TV connections.



Note

For Cisco IP/TV, use RTSP TCP port 554 and TCP 8554.

RTSP applications use the well-known port 554 with TCP (rarely UDP) as a control channel. The security appliance only supports TCP, in conformity with RFC 2326. This TCP control channel is used to negotiate the data channels that is used to transmit audio/video traffic, depending on the transport mode that is configured on the client.

The supported RDT transports are: rtp/avp, rtp/avp/udp, x-real-rdt, x-real-rdt/udp, and x-pn-tng/udp.

The security appliance parses Setup response messages with a status code of 200. If the response message is travelling inbound, the server is outside relative to the security appliance and dynamic channels need to be opened for connections coming inbound from the server. If the response message is outbound, then the security appliance does not need to open dynamic channels.

Because RFC 2326 does not require that the client and server ports must be in the SETUP response message, the security appliance keeps state and remembers the client ports in the SETUP message. QuickTime places the client ports in the SETUP message and then the server responds with only the server ports.

RTSP inspection does not support PAT or dual-NAT. Also, the security appliance cannot recognize HTTP cloaking where RTSP messages are hidden in the HTTP messages.

Using RealPlayer

When using RealPlayer, it is important to properly configure transport mode. For the security appliance, add an **access-list** command from the server to the client or vice versa. For RealPlayer, change transport mode by clicking **Options>Preferences>Transport>RTSP Settings**.

If using TCP mode on the RealPlayer, select the **Use TCP to Connect to Server** and **Attempt to use TCP for all content** check boxes. On the security appliance, there is no need to configure the inspection engine.

If using UDP mode on the RealPlayer, select the **Use TCP to Connect to Server** and **Attempt to use UDP for static content** check boxes, and for live content not available via Multicast. On the security appliance, add an **inspect rtsp port** command.

Restrictions and Limitations

The following restrictions apply to the **inspect rtsp** command. The security appliance does not support multicast RTSP or RTSP messages over UDP.

- PAT is not supported with the **inspect rtsp** command.
- The security appliance does not have the ability to recognize HTTP cloaking where RTSP messages are hidden in the HTTP messages.
- The security appliance cannot perform NAT on RTSP messages because the embedded IP addresses are contained in the SDP files as part of HTTP or RTSP messages. Packets could be fragmented and security appliance cannot perform NAT on fragmented packets.
- With Cisco IP/TV, the number of NATs the security appliance performs on the SDP part of the message is proportional to the number of program listings in the Content Manager (each program listing can have at least six embedded IP addresses).
- You can configure NAT for Apple QuickTime 4 or RealPlayer. Cisco IP/TV only works with NAT if the Viewer and Content Manager are on the outside network and the server is on the inside network.

Configuring RTSP Inspection

To configure RTSP application inspection, perform the following steps:

- Step 1** Define access control lists to identify the two ports required for receiving RTSP traffic. For example, the following commands identify the default ports for RTSP inspection:

```
hostname(config)# access-list rtsp_acl permit tcp any any eq 554
hostname(config)# access-list rtsp_acl permit tcp any any eq 8554
```

- Step 2** Name the traffic class by entering the following command in global configuration mode:

```
hostname(config)# class-map class_map_name
```

Replace *class_map_name* with the name of the traffic class, for example:

```
hostname(config)# class-map rtsp_port
```

When you enter the **class-map** command, the CLI enters the class map configuration mode, and the prompt changes, as in the following example:

```
hostname(config-cmap)#
```

- Step 3** In the class map configuration mode, define the **match** command, as in the following example:

```
hostname(config-cmap)# match access-list rtsp_acl
hostname(config-cmap)# exit
hostname(config)#
```

- Step 4** Name the policy map by entering the following command:

```
hostname(config)# policy-map policy_map_name
```

Replace *policy_map_name* with the name of the policy map, as in the following example:

```
hostname(config)# policy-map sample_policy
```

The CLI enters the policy map configuration mode and the prompt changes accordingly, as follows:

```
hostname(config-pmap)#
```

- Step 5** Specify the traffic class defined in [Step 2](#) to be included in the policy map by entering the following command:

```
hostname(config-pmap)# class class_map_name
```

For example, the following command assigns the `rtsp_port` traffic class to the current policy map.

```
hostname(config-pmap)# class rtsp_port
```

The CLI enters the policy map class configuration mode and the prompt changes accordingly, as follows:

```
hostname(config-pmap-c)#
```

- Step 6** (Optional) To change the default port used by the security appliance for receiving RTSP traffic, enter the following command:

```
hostname(config-pmap-c)# inspect rtsp
```

- Step 7** Return to policy map configuration mode by entering the following command:

```
hostname(config-pmap-c)# exit
hostname(config-pmap)#
```

- Step 8** Return to global configuration mode by entering the following command:

```
hostname(config-pmap)# exit
hostname(config)#
```

- Step 9** Apply the policy map globally or to a specific interface by entering the following command:

```
hostname(config)# service-policy policy_map_name [global | interface interface_ID
```

Replace *policy_map_name* with the policy map you configured in [Step 4](#), and identify all the interfaces with the **global** option or a specific interface using the name assigned with the **nameif** command.

For example, the following command applies the `sample_policy` to the `outside` interface:

```
hostname(config)# service-policy sample_policy interface outside
```

The following command applies the `sample_policy` to all the security appliance interfaces:

```
hostname(config)# service-policy sample_policy global
```

Example 21-9 Enabling and Configuring RTSP Inspection

You enable the RTSP inspection engine as shown in the following example, which creates a class map to match RTSP traffic on the default ports (554 and 8554). The service policy is then applied to the `outside` interface.

```
hostname(config)# access-list rtsp_acl permit tcp any any eq 554
hostname(config)# access-list rtsp_acl permit tcp any any eq 8554
hostname(config)# class-map rtsp-traffic
hostname(config-cmap)# match access-list rtsp_acl
hostname(config-cmap)# exit
hostname(config)# policy-map sample_policy
```

```
hostname(config-pmap) # class rtsp_port
hostname(config-pmap-c) # inspect rtsp 554
hostname(config-pmap-c) # inspect rtsp 8554
hostname(config-pmap-c) # exit
hostname(config) # service-policy sample_policy interface outside
```

To enable RTSP inspection for all interfaces, enter the **global** parameter in place of **interface outside**.

Managing SIP Inspection

This section describes how to enable SIP application inspection and change the default port configuration. This section includes the following topics:

- [SIP Inspection Overview, page 21-55](#)
- [SIP Instant Messaging, page 21-56](#)
- [Enabling and Configuring SIP Inspection, page 21-57](#)
- [Configuring SIP Timeout Values, page 21-58](#)
- [Verifying and Monitoring SIP Inspection, page 21-59](#)

SIP Inspection Overview

SIP, as defined by the IETF, enables call handling sessions, particularly two-party audio conferences, or “calls.” SIP works with SDP for call signalling. SDP specifies the ports for the media stream. Using SIP, the security appliance can support any SIP VoIP gateways and VoIP proxy servers. SIP and SDP are defined in the following RFCs:

- SIP: Session Initiation Protocol, RFC 2543
- SDP: Session Description Protocol, RFC 2327

To support SIP calls through the security appliance, signaling messages for the media connection addresses, media ports, and embryonic connections for the media must be inspected, because while the signaling is sent over a well-known destination port (UDP/TCP 5060), the media streams are dynamically allocated. Also, SIP embeds IP addresses in the user-data portion of the IP packet. SIP inspection applies NAT for these embedded IP addresses.

The following limitations and restrictions apply when using PAT with SIP:

- If a remote endpoint tries to register with a SIP proxy on a network protected by the security appliance, the registration will fail under very specific conditions. These conditions are when PAT is configured for the remote endpoint, the SIP registrar server is on the outside network, and when the port is missing in the contact field in the REGISTER message sent by the endpoint to the proxy server.
- When using PAT, if a SIP device transmits a packet in which the SDP portion has an IP address in the owner/creator (o=) field that is different than the IP address in the connection field (c=), the IP address in the o= field may not be properly translated. This is due to a limitation in the SIP protocol, which does not provide a port value in the o= field.

SIP Instant Messaging

Instant Messaging refers to the transfer of messages between users in near real-time. SIP supports the Chat feature on Windows XP using Windows Messenger RTC Client version 4.7.0105 only. The MESSAGE/INFO methods and 202 Accept response are used to support IM as defined in the following RFCs:

- Session Initiation Protocol (SIP)-Specific Event Notification, RFC 3265
- Session Initiation Protocol (SIP) Extension for Instant Messaging, RFC 3428

MESSAGE/INFO requests can come in at any time after registration/subscription. For example, two users can be online at any time, but not chat for hours. Therefore, the SIP inspection engine opens pinholes that time out according to the configured SIP timeout value. This value must be configured at least five minutes longer than the subscription duration. The subscription duration is defined in the Contact Expires value and is typically 30 minutes.

Because MESSAGE/INFO requests are typically sent using a dynamically allocated port other than port 5060, they are required to go through the SIP inspection engine.



Note

Only the Chat feature is currently supported. Whiteboard, File Transfer, and Application Sharing are not supported. RTC Client 5.0 is not supported.

SIP inspection NATs the SIP text-based messages, recalculates the content length for the SDP portion of the message, and recalculates the packet length and checksum. It dynamically opens media connections for ports specified in the SDP portion of the SIP message as address/ports on which the endpoint should listen.

SIP inspection has a database with indices CALL_ID/FROM/TO from the SIP payload that identifies the call, as well as the source and destination. Contained within this database are the media addresses and media ports that were contained in the SDP media information fields and the media type. There can be multiple media addresses and ports for a session. RTP/RTCP connections are opened between the two endpoints using these media addresses/ports.

The well-known port 5060 must be used on the initial call setup (INVITE) message. However, subsequent messages may not have this port number. The SIP inspection engine opens signaling connection pinholes, and marks these connections as SIP connections. This is done for the messages to reach the SIP application and be NATed.

As a call is set up, the SIP session is considered in the “transient” state until the media address and media port is received in a Response message from the called endpoint indicating the RTP port the called endpoint listen on. If there is a failure to receive the response messages within one minute, the signaling connection is torn down.

Once the final handshake is made, the call state is moved to active and the signaling connection remains until a BYE message is received.

If an inside endpoint initiates a call to an outside endpoint, a media hole is opened to the outside interface to allow RTP/RTCP UDP packets to flow to the inside endpoint media address and media port specified in the INVITE message from the inside endpoint. Unsolicited RTP/RTCP UDP packets to an inside interface does not traverse the security appliance, unless the security appliance configuration specifically allows it.

Enabling and Configuring SIP Inspection

To enable SIP inspection or change the default port used for receiving SIP traffic, perform the following steps:

- Step 1** Name the traffic class by entering the following command in global configuration mode:

```
hostname(config)# class-map class_map_name
```

Replace *class_map_name* with the name of the traffic class, for example:

```
hostname(config)# class-map sip_port
```

When you enter the **class-map** command, the CLI enters the class map configuration mode, and the prompt changes, as in the following example:

```
hostname(config-cmap)#
```

- Step 2** In the class map configuration mode, define the **match** command, as in the following example:

```
hostname(config-cmap)# match port tcp eq 5060  
hostname(config-cmap)# exit  
hostname(config)#
```

To assign a range of continuous ports, enter the **range** keyword, as in the following example:

```
hostname(config-cmap)# match port tcp range 5060-5070
```

To assign more than one non-contiguous port for SIP inspection, enter the **access-list** command and define an access control entry to match each port. Then enter the **match** command to associate the access lists with the SIP traffic class.

- Step 3** Name the policy map by entering the following command:

```
hostname(config)# policy-map policy_map_name
```

Replace *policy_map_name* with the name of the policy map, as in the following example:

```
hostname(config)# policy-map sample_policy
```

The CLI enters the policy map configuration mode and the prompt changes accordingly, as follows:

```
hostname(config-pmap)#
```

- Step 4** Specify the traffic class defined in [Step 1](#) to be included in the policy map by entering the following command:

```
hostname(config-pmap)# class class_map_name
```

For example, the following command assigns the *sip_port* traffic class to the current policy map.

```
hostname(config-pmap)# class sip_port
```

The CLI enters the policy map class configuration mode and the prompt changes accordingly, as follows:

```
hostname(config-pmap-c)#
```

- Step 5** (Optional) To change the default port used by the security appliance for receiving SIP traffic, enter the following command:

```
hostname(config-pmap-c)# inspect sip
```

Step 6 Return to policy map configuration mode by entering the following command:

```
hostname(config-pmap-c)# exit
hostname(config-pmap)#
```

Step 7 Return to global configuration mode by entering the following command:

```
hostname(config-pmap)# exit
hostname(config)#
```

Step 8 Apply the policy map globally or to a specific interface by entering the following command:

```
hostname(config)# service-policy policy_map_name [global | interface interface_ID
```

Replace `policy_map_name` with the policy map you configured in [Step 3](#), and identify all the interfaces with the **global** option or a specific interface using the name assigned with the **nameif** command.

For example, the following command applies the `sample_policy` to the `outside` interface:

```
hostname(config)# service-policy sample_policy interface outside
```

The following command applies the `sample_policy` to the all the security appliance interfaces:

```
hostname(config)# service-policy sample_policy global
```

You enable the SIP inspection engine as shown in [Example 21-8](#), which creates a class map to match SIP traffic on the default port (5060). The service policy is then applied to the `outside` interface.

Example 21-10 Enabling SIP Application Inspection

```
hostname(config)# class-map sip_port
hostname(config-cmap)# match port tcp eq 5060
hostname(config-cmap)# exit
hostname(config)# policy-map sample_policy
hostname(config-pmap)# class sip_port
hostname(config-pmap-c)# inspect sip 5060
hostname(config-pmap-c)# exit
hostname(config)# service-policy sample_policy interface outside
```

To enable SIP inspection for all interfaces, enter the **global** parameter in place of **interface outside**.

Configuring SIP Timeout Values

The media connections are torn down within two minutes after the connection becomes idle. This is, however, a configurable timeout and can be set for a shorter or longer period of time. To configure the timeout for the SIP control connection, enter the following command:

```
timeout sip
```

This command configures the idle timeout after which a SIP control connection is closed.

To configure the timeout for the SIP media connection, enter the following command:

```
timeout sip_media
```

This command configures the idle timeout after which a SIP media connection is closed.

Verifying and Monitoring SIP Inspection

The **show sip** command assists in troubleshooting SIP inspection engine issues and is described with the **inspect protocol sip udp 5060** command. The **show timeout sip** command displays the timeout value of the designated protocol.

The **show sip** command displays information for SIP sessions established across the security appliance. Along with the **debug sip** and **show local-host** commands, this command is used for troubleshooting SIP inspection engine issues.



Note

We recommend that you configure the **pager** command before entering the **show sip** command. If there are a lot of SIP session records and the **pager** command is not configured, it takes a while for the **show sip** command output to reach its end.

The following is sample output from the **show sip** command:

```
hostname# show sip
Total: 2
call-id c3943000-960ca-2e43-228f@10.130.56.44
    state Call init, idle 0:00:01
call-id c3943000-860ca-7e1f-11f7@10.130.56.45
    state Active, idle 0:00:06
```

This sample shows two active SIP sessions on the security appliance (as shown in the Total field). Each call-id represents a call.

The first session, with the call-id c3943000-960ca-2e43-228f@10.130.56.44, is in the state Call Init, which means the session is still in call setup. Call setup is not complete until a final response to the call has been received. For instance, the caller has already sent the INVITE, and maybe received a 100 Response, but has not yet seen the 200 OK, so the call setup is not complete yet. Any non-1xx response message is considered a final response. This session has been idle for 1 second.

The second session is in the state Active, in which call setup is complete and the endpoints are exchanging media. This session has been idle for 6 seconds.

Managing Skinny (SCCP) Inspection

This section describes how to enable SCCP application inspection and change the default port configuration. This section includes the following topics:

- [SCCP Inspection Overview, page 21-60](#)
- [Supporting Cisco IP Phones, page 21-60](#)
- [Restrictions and Limitations, page 21-60](#)
- [Verifying and Monitoring SCCP Inspection, page 21-62](#)

SCCP Inspection Overview

Skiny (SCCP) is a simplified protocol used in VoIP networks. Cisco IP Phones using SCCP can coexist in an H.323 environment. When used with Cisco CallManager, the SCCP client can interoperate with H.323 compliant terminals. Application layer functions in the security appliance recognize SCCP Version 3.3. The functionality of the application layer software ensures that all SCCP signaling and media packets can traverse the security appliance by providing NAT of the SCCP signaling packets.

There are five versions of the SCCP protocol: 2.4, 3.0.4, 3.1.1, 3.2, and 3.3.2. The security appliance supports all versions through Version 3.3.2. The security appliance provides both PAT and NAT support for SCCP. PAT is necessary if you have limited numbers of global IP addresses for use by IP phones.

Normal traffic between the Cisco CallManager and Cisco IP Phones uses SCCP and is handled by SCCP inspection without any special configuration. The security appliance also supports DHCP options 150 and 66, which allow the security appliance to send the location of a TFTP server to Cisco IP Phones and other DHCP clients. Cisco IP Phones might also include DHCP option 3 in their requests, which sets the default route. For more information, see the “Using Cisco IP Phones with a DHCP Server” section in Chapter 8, “Configuring IP Networking.”

Supporting Cisco IP Phones

In topologies where Cisco CallManager is located on the higher security interface with respect to the Cisco IP Phones, if NAT is required for the Cisco CallManager IP address, the mapping must be **static** because a Cisco IP Phone requires the Cisco CallManager IP address to be specified explicitly in its configuration. An identity static entry allows the Cisco CallManager on the higher security interface to accept registrations from the Cisco IP Phones.

Cisco IP Phones require access to a TFTP server to download the configuration information they need to connect to the Cisco CallManager server.

When the Cisco IP Phones are on a lower security interface compared to the TFTP server, you must use an access list to connect to the protected TFTP server on UDP port 69. While you do need a static entry for the TFTP server, this does not have to be an identity static entry. When using NAT, an identity static entry maps to the same IP address. When using PAT, it maps to the same IP address and port.

When the Cisco IP Phones are on a higher security interface compared to the TFTP server and Cisco CallManager, no access list or static entry is required to allow the Cisco IP Phones to initiate the connection.

Restrictions and Limitations

The following are limitations that apply to the current version of PAT and NAT support for SCCP:

- PAT does not work with configurations containing the **alias** command.
- Outside NAT or PAT is *not* supported.



Note

Stateful Failover of SCCP calls is now supported except for calls that are in the middle of call setup.

If the address of an internal Cisco CallManager is configured for NAT or PAT to a different IP address or port, registrations for external Cisco IP Phones fail because the security appliance currently does not support NAT or PAT for the file content transferred over TFTP. Although the security appliance does

support NAT of TFTP messages, and opens a pinhole for the TFTP file to traverse the security appliance, the security appliance cannot translate the Cisco CallManager IP address and port embedded in the Cisco IP Phone configuration files that are being transferred using TFTP during phone registration.

To enable SCCP inspection or change the default port used for receiving SCCP traffic, perform the following steps:

Step 1 Name the traffic class by entering the following command in global configuration mode:

```
hostname(config)# class-map class_map_name
```

Replace *class_map_name* with the name of the traffic class, for example:

```
hostname(config)# class-map sccp_port
```

When you enter the **class-map** command, the CLI enters the class map configuration mode, and the prompt changes, as in the following example:

```
hostname(config-cmap)#
```

Step 2 In the class map configuration mode, define the **match** command, as in the following example:

```
hostname(config-cmap)# match port tcp eq 2000  
hostname(config-cmap)# exit  
hostname(config)#
```

To assign a range of continuous ports, enter the **range** keyword, as in the following example:

```
hostname(config-cmap)# match port tcp range 2000-2010
```

To assign more than one non-contiguous port for SCCP inspection, enter the **access-list** command and define an access control entry to match each port. Then enter the **match** command to associate the access lists with the SCCP traffic class.

Step 3 Name the policy map by entering the following command:

```
hostname(config)# policy-map policy_map_name
```

Replace *policy_map_name* with the name of the policy map, as in the following example:

```
hostname(config)# policy-map sample_policy
```

The CLI enters the policy map configuration mode and the prompt changes accordingly, as follows:

```
hostname(config-pmap)#
```

Step 4 Specify the traffic class defined in [Step 1](#) to be included in the policy map by entering the following command:

```
hostname(config-pmap)# class class_map_name
```

For example, the following command assigns the `sccp_port` traffic class to the current policy map:

```
hostname(config-pmap)# class sccp_port
```

The CLI enters the policy map class configuration mode and the prompt changes accordingly, as follows:

```
hostname(config-pmap-c)#
```

Step 5 (Optional) To change the default port used by the security appliance for receiving SCCP traffic, enter the following command:

```
hostname(config-pmap-c)# inspect skinny
```

Step 6 Return to policy map configuration mode by entering the following command:

```
hostname(config-pmap-c)# exit
hostname(config-pmap)#
```

Step 7 Return to global configuration mode by entering the following command:

```
hostname(config-pmap)# exit
hostname(config)#
```

Step 8 Apply the policy map globally or to a specific interface by entering the following command:

```
hostname(config)# service-policy policy_map_name [global | interface interface_ID
```

Replace `policy_map_name` with the policy map you configured in [Step 3](#), and identify all the interfaces with the **global** option or a specific interface using the name assigned with the **nameif** command.

For example, the following command applies the `sample_policy` to the `outside` interface:

```
hostname(config)# service-policy sample_policy interface outside
```

The following command applies the `sample_policy` to the all the security appliance interfaces:

```
hostname(config)# service-policy sample_policy global
```

You enable the SCCP inspection engine as shown in [Example 21-9](#), which creates a class map to match SCCP traffic on the default port (2000). The service policy is then applied to the `outside` interface.

Example 21-11 Enabling SCCP Application Inspection

```
hostname(config)# class-map sccp_port
hostname(config-cmap)# match port tcp eq 2000
hostname(config-cmap)# exit
hostname(config)# policy-map sample_policy
hostname(config-pmap)# class sccp_port
hostname(config-pmap-c)# inspect skinny
hostname(config-pmap-c)# exit
hostname(config)# service-policy sample_policy interface outside
```

Verifying and Monitoring SCCP Inspection

The **show skinny** command assists in troubleshooting SCCP (Skinny) inspection engine issues. The following is sample output from the **show skinny** command under the following conditions. There are two active Skinny sessions set up across the security appliance. The first one is established between an internal Cisco IP Phone at local address 10.0.0.11 and an external Cisco CallManager at 172.18.1.33. TCP port 2000 is the CallManager. The second one is established between another internal Cisco IP Phone at local address 10.0.0.22 and the same Cisco CallManager.

```
hostname# show skinny
-----
LOCAL                FOREIGN                STATE
-----
1      10.0.0.11/52238      172.18.1.33/2000      1
  MEDIA 10.0.0.11/22948 172.18.1.22/20798
2      10.0.0.22/52232     172.18.1.33/2000      1
  MEDIA 10.0.0.22/20798 172.18.1.11/22948
```

The output indicates that a call has been established between two internal Cisco IP Phones. The RTP listening ports of the first and second phones are UDP 22948 and 20798 respectively.

The following is sample output from the **show xlate debug** command for these Skinny connections:

```
hostname# show xlate debug
2 in use, 2 most used
Flags: D - DNS, d - dump, I - identity, i - inside, n - no random,
      r - portmap, s - static
NAT from inside:10.0.0.11 to outside:172.18.1.11 flags si idle 0:00:16 timeout 0:05:00
NAT from inside:10.0.0.22 to outside:172.18.1.22 flags si idle 0:00:14 timeout 0:05:00
```

Managing SMTP and Extended SMTP Inspection

This section describes how to enable SMTP and ESMTP application inspection and change the default port configuration. This section includes the following topics:

- [SMTP and Extended SMTP Inspection Overview, page 21-63](#)
- [Enabling and Configuring SMTP and Extended SMTP Application Inspection, page 21-64](#)

SMTP and Extended SMTP Inspection Overview

ESMTP application inspection provides improved protection against SMTP-based attacks by restricting the types of SMTP commands that can pass through the security appliance and by adding monitoring capabilities.

ESMTP is an enhancement to the SMTP protocol and is similar in most respects to SMTP. For convenience, the term SMTP is used in this document to refer to both SMTP and ESMTP. The application inspection process for extended SMTP is similar to SMTP application inspection and includes support for SMTP sessions. Most commands used in an extended SMTP session are the same as those used in an SMTP session but an ESMTP session is considerably faster and offers more options related to reliability and security, such as delivery status notification.

The **inspect esmtp** command includes the functionality previously provided by the **inspect smtp** command, and provides additional support for some extended SMTP commands. Extended SMTP application inspection adds support for eight extended SMTP commands, including AUTH, EHLO, ETRN, HELP, SAML, SEND, SOML and VRFY. Along with the support for seven RFC 821 commands (DATA, HELO, MAIL, NOOP, QUIT, RCPT, RSET), the security appliance supports a total of fifteen SMTP commands.

Other extended SMTP commands, such as ATRN, STARTLS, ONEX, VERB, CHUNKING, and private extensions are not supported. Unsupported commands are translated into Xs, which are rejected by the internal server. This results in a message such as “500 Command unknown: 'XXX'.” Incomplete commands are discarded.

If you enter the **inspect smtp** command, the security appliance automatically converts the command into the **inspect esmtp** command, which is the configuration that is shown if you enter the **show running-config** command.

The **inspect esmtp** command changes the characters in the server SMTP banner to asterisks except for the “2”, “0”, “0” characters. Carriage return (CR) and linefeed (LF) characters are ignored.

With SMTP inspection enabled, a Telnet session used for interactive SMTP may hang if the following rules are not observed: SMTP commands must be at least four characters in length; must be terminated with carriage return and line feed; and must wait for a response before issuing the next reply.

An SMTP server responds to client requests with numeric reply codes and optional human-readable strings. SMTP application inspection controls and reduces the commands that the user can use as well as the messages that the server returns. SMTP inspection performs three primary tasks:

- Restricts SMTP requests to seven basic SMTP commands and eight extended commands.
- Monitors the SMTP command-response sequence.
- Generates an audit trail—Audit record 108002 is generated when invalid character embedded in the mail address is replaced. For more information, see RFC 821.

SMTP inspection monitors the command and response sequence for the following anomalous signatures:

- Truncated commands.
- Incorrect command termination (not terminated with <CR><LR>).
- The MAIL and RCPT commands specify who are the sender and the receiver of the mail. Mail addresses are scanned for strange characters. The pipeline character (!) is deleted (changed to a blank space) and “<” ,”>” are only allowed if they are used to define a mail address (“>” must be preceded by “<”).
- Unexpected transition by the SMTP server.
- For unknown commands, the security appliance changes all the characters in the packet to X. In this case, the server generates an error code to the client. Because of the change in the packed, the TCP checksum has to be recalculated or adjusted.
- TCP stream editing.
- Command pipelining.

Enabling and Configuring SMTP and Extended SMTP Application Inspection

To enable SMTP and extended SMTP inspection or change the default port used for receiving SMTP traffic, perform the following steps:

Step 1 Name the traffic class by entering the following command in global configuration mode:

```
hostname(config)# class-map class_map_name
```

Replace *class_map_name* with the name of the traffic class, for example:

```
hostname(config)# class-map smtp_port
```

When you enter the **class-map** command, the CLI enters the class map configuration mode, and the prompt changes, as in the following example:

```
hostname(config-cmap)#
```

Step 2 In the class map configuration mode, define the **match** command, as in the following example:

```
hostname(config-cmap)# match port tcp eq 25
hostname(config-cmap)# exit
hostname(config)#
```

To assign a range of continuous ports, enter the **range** keyword, as in the following example:

```
hostname(config-cmap)# match port tcp range 2025-2030
```

To assign more than one non-contiguous port for SMTP inspection, enter the **access-list** command and define an access control entry to match each port. Then enter the **match** command to associate the access lists with the SMTP traffic class.

Step 3 Name the policy map by entering the following command:

```
hostname(config)# policy-map policy_map_name
```

Replace *policy_map_name* with the name of the policy map, as in the following example:

```
hostname(config)# policy-map sample_policy
```

The CLI enters the policy map configuration mode and the prompt changes accordingly, as follows:

```
hostname(config-pmap)#
```

Step 4 Specify the traffic class defined in [Step 1](#) to be included in the policy map by entering the following command:

```
hostname(config-pmap)# class class_map_name
```

For example, the following command assigns the `smtp_port` traffic class to the current policy map.

```
hostname(config-pmap)# class smtp_port
```

The CLI enters the policy map class configuration mode and the prompt changes accordingly, as follows:

```
hostname(config-pmap-c)#
```

Step 5 (Optional) To change the default port used by the security appliance for receiving SMTP traffic, enter the following command:

```
hostname(config-pmap-c)# inspect esmtip
```

Step 6 Return to policy map configuration mode by entering the following command:

```
hostname(config-pmap-c)# exit  
hostname(config-pmap)#
```

Step 7 Return to global configuration mode by entering the following command:

```
hostname(config-pmap)# exit  
hostname(config)#
```

Step 8 Apply the policy map globally or to a specific interface by entering the following command:

```
hostname(config)# service-policy policy_map_name [global | interface interface_ID]
```

Replace *policy_map_name* with the policy map you configured in [Step 3](#). Identify all the security appliance interfaces with the **global** option or identify a specific interface using the name assigned with the **nameif** command.

For example, the following command applies the `sample_policy` policy map to the `outside` interface:

```
hostname(config)# service-policy sample_policy interface outside
```

The following command applies the `sample_policy` policy map to the all the security appliance interfaces:

```
hostname(config)# service-policy sample_policy global
```

You enable the SMTP inspection engine as shown in [Example 21-10](#), which enables SMTP traffic on the default port (25). The service policy is then applied to the `outside` interface.

Example 21-12 Enabling and Configuring SMTP and ESMTP Inspection

```

hostname(config)# class-map smtp_port
hostname(config-cmap)# match port tcp eq 25
hostname(config-cmap)# exit
hostname(config)# policy-map sample_policy
hostname(config-pmap)# class smtp_port
hostname(config-pmap-c)# inspect esmtp 25
hostname(config-pmap-c)# exit
hostname(config)# service-policy sample_policy interface outside

```

To enable SMTP inspection for all interfaces, enter the **global** parameter in place of **interface outside**.

Managing SNMP Inspection

This section describes how to enable SNMP application inspection and change the default port configuration. This section includes the following topics:

- [SNMP Inspection Overview, page 21-66](#)
- [Enabling and Configuring SNMP Application Inspection, page 21-66](#)

SNMP Inspection Overview

Use the **inspect snmp** command to enable SNMP inspection, using the settings configured with an SNMP map, which you create by entering the **snmp-map** command. Enter the **deny version** command in SNMP map configuration mode to restrict SNMP traffic to a specific version of SNMP.

Earlier versions of SNMP are less secure, so denying SNMP Version 1 traffic may be required by your security policy. To deny a specific version of SNMP, enter the **deny version** command within an SNMP map, which you create by entering the **snmp-map** command. After configuring the SNMP map, you enable the map by entering the **inspect snmp** command and then apply it to one or more interfaces by entering the **service-policy** command.

Enabling and Configuring SNMP Application Inspection

To change the default configuration for SNMP inspection, perform the following steps:

Step 1 Define access control lists to identify the two ports required for receiving SNMP traffic:

```

hostname(config)# access-list snmp_acl permit snmp any any eq 161
hostname(config)# access-list snmp_acl permit snmp any any eq 162

```

Step 2 Name the traffic class by entering the following command in global configuration mode:

```
hostname(config)# class-map class_map_name
```

Replace *class_map_name* with the name of the traffic class, for example:

```
hostname(config)# class-map snmp_port
```

When you enter the **class-map** command, the CLI enters the class map configuration mode, and the prompt changes, as in the following example:

```
hostname(config-cmap)#
```

Step 3 In the class map configuration mode, define the **match** command, as in the following example:

```
hostname(config-cmap)# match access-list snmp_acl
hostname(config-cmap)# exit
hostname(config)#
```

To assign a range of continuous ports, you can also enter the **range** keyword, as in the following example:

```
hostname(config-cmap)# match port snmp range 161-162
```

In this case, you do not need to create access lists for defining the ports on which to enable SNMP application inspection.

Step 4 Create an SNMP map by entering the following command:

```
hostname(config)# snmp-map snmp_map_name
```

Replace *snmp_map_name* with the name of the SNMP map, for example:

```
hostname(config)# snmp-map sample_policy
```

The system enters SNMP map configuration mode and the CLI prompt changes as in the following example:

```
hostname(config-snmp-map)#
```

Step 5 Restrict the configuration of the SNMP map by entering the following command:

```
hostname(config-snmp-map)# deny version version
```

Replace *version* with one or more SNMP versions that you want to restrict, for example:

```
hostname(config-inbound_ftp)# deny version 1
```

Step 6 Name the policy map by entering the following command:

```
hostname(config)# policy-map policy_map_name
```

Replace *policy_map_name* with the name of the policy map, as in the following example:

```
hostname(config)# policy-map sample_policy
```

The CLI enters the policy map configuration mode and the prompt changes accordingly, as follows:

```
hostname(config-pmap)#
```

Step 7 Specify the traffic class defined in [Step 1](#) to be included in the policy map by entering the following command:

```
hostname(config-pmap)# class class_map_name
```

For example, the following command assigns the `snmp_port` traffic class to the current policy map.

```
hostname(config-pmap)# class snmp_port
```

The CLI enters the policy map class configuration mode and the prompt changes accordingly, as follows:

```
hostname(config-pmap-c)#
```

Step 8 To apply strict inspection to the traffic that matches the criteria defined in the traffic class, enter the following command:

```
hostname(config-pmap-c)# inspect snmp snmp_map_name
```

Replace *snmp_map_name* with the SNMP map that you want to use. For example, the following command causes the security appliance to use the SNMP map created in the previous steps:

```
hostname(config-pmap-c)# inspect snmp sample_policy
```

Step 9 Return to policy map configuration mode by entering the following command:

```
hostname(config-pmap-c)# exit
hostname(config-pmap)#
```

Step 10 Return to global configuration mode by entering the following command:

```
hostname(config-pmap)# exit
hostname(config)#
```

Step 11 Apply the policy map globally or to a specific interface by entering the following command:

```
hostname(config)# service-policy policy_map_name [global | interface interface_ID
```

Replace `policy_map_name` with the policy map you configured in [Step 6](#), and identify all the interfaces with the **global** option or a specific interface using the name assigned with the **nameif** command.

For example, the following command applies the `sample_policy` to the `outside` interface:

```
hostname(config)# service-policy sample_policy interface outside
```

To enable strict SNMP application inspection for all interfaces, enter the **global** parameter in place of **interface outside**.

The following command applies the `sample_policy` to the all the security appliance interfaces:

```
hostname(config)# service-policy sample_policy global
```

The following example identifies SNMP traffic, defines an SNMP map, defines a policy, enables SNMP inspection, and applies the policy to the `outside` interface:

Example 21-13 Configuring SNMP Application Inspection

```
hostname(config)# access-list snmp_acl permit snmp eq 161
hostname(config)# access-list snmp_acl permit snmp eq 162
hostname(config)# class-map snmp_port
hostname(config-cmap)# match access-list snmp_acl
hostname(config-cmap)# exit
hostname(config)# snmp-map sample_policy
hostname(config-snmp-map)# deny version 1
hostname(config-snmp-map)# exit
hostname(config)# policy-map sample_policy
hostname(config-pmap)# class snmp_port
hostname(config-pmap-c)# inspect snmp sample_policy
hostname(config-pmap-c)# exit
```

Managing Sun RPC Inspection

This section describes how to enable Sun RPC application inspection, change the default port configuration, and manage the Sun RPC service table. This section includes the following topics:

- [Sun RPC Inspection Overview, page 21-69](#)
- [Enabling and Configuring Sun RPC Inspection, page 21-69](#)
- [Managing Sun RPC Services, page 21-71](#)
- [Verifying and Monitoring Sun RPC Inspection, page 21-72](#)

Sun RPC Inspection Overview

To enable Sun RPC application inspection or to change the ports to which the security appliance listens, use the **inspect sunrpc** command in policy map class configuration mode, which is accessible by using the **class** command within policy map configuration mode. To remove the configuration, use the **no** form of this command.

The **inspect sunrpc** command enables or disables application inspection for the Sun RPC protocol. Sun RPC is used by NFS and NIS. Sun RPC services can run on any port on the system. When a client attempts to access an Sun RPC service on a server, it must find out which port that service is running on. It does this by querying the portmapper process on the well-known port of 111.

The client sends the Sun RPC program number of the service, and gets back the port number. From this point on, the client program sends its Sun RPC queries to that new port. When a server sends out a reply, the security appliance intercepts this packet and opens both embryonic TCP and UDP connections on that port.

**Note**

NAT or PAT of Sun RPC payload information is not supported.

Enabling and Configuring Sun RPC Inspection

**Note**

To enable or configure Sun RPC inspection over UDP, you do not have to define a separate traffic class or a new policy map. You simply add the **inspect sunrpc** command into a policy map whose traffic class is defined by the default traffic class. An example of this configuration is shown in [Example 21-15 on page 21-71](#).

To enable Sun RPC inspection or change the default port used for receiving Sun RPC traffic using TCP, perform the following steps:

Step 1 Name the traffic class by entering the following command in global configuration mode:

```
hostname(config)# class-map class_map_name
```

Replace *class_map_name* with the name of the traffic class, as in the following example:

```
hostname(config)# class-map sunrpc_port
```

When you enter the **class-map** command, the CLI enters the class map configuration mode, and the prompt changes, as in the following example:

```
hostname(config-cmap)#
```

Step 2 In the class map configuration mode, define the **match** command, as in the following example:

```
hostname(config-cmap)# match port tcp eq 111
hostname(config-cmap)# exit
hostname(config)#
```

To assign a range of continuous ports, enter the **range** keyword, as in the following example:

```
hostname(config-cmap)# match port tcp range 111-112
```

To assign more than one non-contiguous port for Sun RPC inspection, enter the **access-list** command and define an access control entry to match each port. Then enter the **match** command to associate the access lists with the Sun RPC traffic class.

Step 3 Name the policy map by entering the following command:

```
hostname(config)# policy-map policy_map_name
```

Replace *policy_map_name* with the name of the policy map, as in the following example:

```
hostname(config)# policy-map sample_policy
```

The CLI enters the policy map configuration mode and the prompt changes accordingly, as follows:

```
hostname(config-pmap)#
```

Step 4 Specify the traffic class defined in [Step 1](#) to be included in the policy map by entering the following command:

```
hostname(config-pmap)# class class_map_name
```

For example, the following command assigns the `sunrpc_port` traffic class to the current policy map:

```
hostname(config-pmap)# class sunrpc_port
```

The CLI enters the policy map class configuration mode and the prompt changes accordingly, as follows:

```
hostname(config-pmap-c)#
```

Step 5 To enable Sun RPC application inspection, enter the following command:

```
hostname(config-pmap-c)# inspect sunrpc
```

Step 6 Return to policy map configuration mode by entering the following command:

```
hostname(config-pmap-c)# exit
hostname(config-pmap)#
```

Step 7 Return to global configuration mode by entering the following command:

```
hostname(config-pmap)# exit
hostname(config)#
```

Step 8 Apply the policy map globally or to a specific interface by entering the following command:

```
hostname(config)# service-policy policy_map_name [global | interface interface_ID]
```

Replace *policy_map_name* with the policy map you configured in [Step 5](#), and identify all the interfaces with the **global** option or a specific interface using the name assigned with the **nameif** command.

For example, the following command applies the `sample_policy` to the outside interface:

```
hostname(config)# service-policy sample_policy interface outside
```

The following command applies the `sample_policy` to all the security appliance interfaces:

```
hostname(config)# service-policy sample_policy global
```

Example 21-14 Enabling and Configuring Sun RPC Inspection (TCP)

You enable the Sun RPC inspection engine as shown in the following example, which creates a class map to match Sun RPC traffic on TCP port 111. The service policy is then applied to the outside interface.

```
hostname(config)# class-map sunrpc_port
hostname(config-cmap)# match port tcp eq 111
hostname(config-cmap)# exit
hostname(config)# policy-map sample_policy
hostname(config-pmap)# class sunrpc_port
hostname(config-pmap-c)# inspect sunrpc
hostname(config-pmap-c)# exit
hostname(config)# service-policy sample_policy interface outside
```

To enable Sun RPC inspection for all interfaces, use the `global` parameter in place of `interface outside`.

Example 21-15 Enabling and Configuring Sun RPC Inspection (TCP)

To enable Sun RPC over UDP, simply add the `inspect sunrpc` command to a policy map whose traffic class is defined by the default traffic class, as shown in the following example:

```
hostname(config)# policy-map asa_global_fw_policy
hostname(config-pmap)# class inspection_default
hostname(config-pmap-c)# inspect sunrpc
```

Managing Sun RPC Services

Use the Sun RPC services table to control Sun RPC traffic through the security appliance based on established Sun RPC sessions. To create entries in the Sun RPC services table, use the `sunrpc-server` command in global configuration mode. To remove Sun RPC services table entries from the configuration, use the `no` form of this command.

You can use this command to specify the timeout after which the pinhole that was opened by Sun RPC application inspection will be closed. For example, to create a timeout of 30 minutes to the Sun RPC server with the IP address 192.168.100.2, enter the following command:

```
hostname(config)# sunrpc-server inside 192.168.100.2 255.255.255.255 service 100003
protocol tcp 111 timeout 00:30:00
```

This command specifies that the pinhole that was opened by Sun RPC application inspection will be closed after 30 minutes. In this example, the Sun RPC server is on the inside interface using TCP port 111. You can also specify UDP, a different port number, or a range of ports. To specify a range of ports, separate the starting and ending port numbers in the range with a hyphen (for example, 111-113).

The service type identifies the mapping between a specific service type and the port number used for the service. To determine the service type, which in this example is 100003, use the `sunrpcinfo` command at the UNIX or Linux command line on the Sun RPC server machine.

To clear the Sun RPC configuration, enter the following command.

```
hostname(config)# clear configure sunrpc-server
```

This removes the configuration performed using the **sunrpc-server** command. The **sunrpc-server** command allows pinholes to be created with a specified timeout.

To clear the active Sun RPC services, enter the following command:

```
hostname(config)# clear sunrpc-server active
```

This clears the pinholes that are opened by Sun RPC application inspection for specific services, such as NFS or NIS.

Verifying and Monitoring Sun RPC Inspection

The sample output in this section is for a Sun RPC server with an IP address of 192.168.100.2 on the inside interface and a Sun RPC client with an IP address of 209.168.200.5 on the outside interface.

To view information about the current Sun RPC connections, enter the **show conn** command. The following is sample output from the **show conn** command:

```
hostname# show conn
15 in use, 21 most used
UDP out 209.165.200.5:800 in 192.168.100.2:2049 idle 0:00:04 flags -
UDP out 209.165.200.5:714 in 192.168.100.2:111 idle 0:00:04 flags -
UDP out 209.165.200.5:712 in 192.168.100.2:647 idle 0:00:05 flags -
UDP out 192.168.100.2:0 in 209.165.200.5:714 idle 0:00:05 flags i
hostname(config)#
```

To display the information about the Sun RPC service table configuration, enter the **show running-config sunrpc-server** command. The following is sample output from the **show running-config sunrpc-server** command:

```
hostname(config)# show running-config sunrpc-server
sunrpc-server inside 192.168.100.2 255.255.255.255 service 100003 protocol UDP port 111
timeout 0:30:00
sunrpc-server inside 192.168.100.2 255.255.255.255 service 100005 protocol UDP port 111
timeout 0:30:00
```

This output shows that a timeout interval of 30 minutes is configured on UDP port 111 for the Sun RPC server with the IP address 192.168.100.2 on the inside interface.

To display the pinholes open for Sun RPC services, enter the **show sunrpc-server active** command. The following is sample output from **show sunrpc-server active** command:

```
hostname# show sunrpc-server active
LOCAL FOREIGN SERVICE TIMEOUT
-----
1 209.165.200.5/0 192.168.100.2/2049 100003 0:30:00
2 209.165.200.5/0 192.168.100.2/2049 100003 0:30:00
3 209.165.200.5/0 192.168.100.2/647 100005 0:30:00
4 209.165.200.5/0 192.168.100.2/650 100005 0:30:00
```

The entry in the LOCAL column shows the IP address of the client or server on the inside interface, while the value in the FOREIGN column shows the IP address of the client or server on the outside interface.

To view information about the Sun RPC services running on a Sun RPC server, enter the **rpcinfo -p** command from the Linux or UNIX server command line. The following is sample output from the **rpcinfo -p** command:

```
sunrpcserver:~ # rpcinfo -p
program vers proto port
100000 2 tcp 111 portmapper
100000 2 udp 111 portmapper
100024 1 udp 632 status
100024 1 tcp 635 status
100003 2 udp 2049 nfs
100003 3 udp 2049 nfs
100003 2 tcp 2049 nfs
100003 3 tcp 2049 nfs
100021 1 udp 32771 nlockmgr
100021 3 udp 32771 nlockmgr
100021 4 udp 32771 nlockmgr
100021 1 tcp 32852 nlockmgr
100021 3 tcp 32852 nlockmgr
100021 4 tcp 32852 nlockmgr
100005 1 udp 647 mountd
100005 1 tcp 650 mountd
100005 2 udp 647 mountd
100005 2 tcp 650 mountd
100005 3 udp 647 mountd
100005 3 tcp 650 mountd
```

In this output, port 647 corresponds to the mountd daemon running over UDP. The mountd process would more commonly be using port 32780. The mountd process running over TCP uses port 650 in this example.



Configuring ARP Inspection and Bridging Parameters

Transparent Firewall Mode Only

This chapter describes how to enable ARP inspection and how to customize bridging operations for the security appliance. In multiple context mode, the commands in this chapter can be entered in a security context, but not the system.

This chapter includes the following sections:

- [Configuring ARP Inspection, page 22-1](#)
- [Customizing the MAC Address Table, page 22-3](#)

Configuring ARP Inspection

This section describes ARP inspection and how to enable it, and includes the following topics:

- [ARP Inspection Overview, page 22-1](#)
- [Adding a Static ARP Entry, page 22-2](#)
- [Enabling ARP Inspection, page 22-2](#)

ARP Inspection Overview

By default, all ARP packets are allowed through the security appliance. You can control the flow of ARP packets by enabling ARP inspection.

When you enable ARP inspection, the security appliance compares the MAC address, IP address, and source interface in all ARP packets to static entries in the ARP table, and takes the following actions:

- If the IP address, MAC address, and source interface match an ARP entry, the packet is passed through.
- If there is a mismatch between the MAC address, the IP address, or the interface, then the security appliance drops the packet.
- If the ARP packet does not match any entries in the static ARP table, then you can set the security appliance to either forward the packet out all interfaces (flood), or to drop the packet.



Note The dedicated management interface, if present, never floods packets even if this parameter is set to flood.

ARP inspection prevents malicious users from impersonating other hosts or routers (known as ARP spoofing). ARP spoofing can enable a “man-in-the-middle” attack. For example, a host sends an ARP request to the gateway router; the gateway router responds with the gateway router MAC address. The attacker, however, sends another ARP response to the host with the attacker MAC address instead of the router MAC address. The attacker can now intercept all the host traffic before forwarding it on to the router.

ARP inspection ensures that an attacker cannot send an ARP response with the attacker MAC address, so long as the correct MAC address and the associated IP address are in the static ARP table.

Adding a Static ARP Entry

ARP inspection compares ARP packets with static ARP entries in the ARP table. To add a static ARP entry, enter the following command:

```
hostname(config)# arp interface_name ip_address mac_address
```

For example, to allow ARP responses from the router at 10.1.1.1 with the MAC address 0009.7cbe.2100 on the outside interface, enter the following command:

```
hostname(config)# arp outside 10.1.1.1 0009.7cbe.2100
```



Note

The transparent firewall uses dynamic ARP entries in the ARP table for traffic to and from the security appliance, such as management traffic.

Enabling ARP Inspection

To enable ARP inspection, enter the following command:

```
hostname(config)# arp-inspection interface_name enable [flood | no-flood]
```

Where **flood** forwards non-matching ARP packets out all interfaces, and **no-flood** drops non-matching packets.



Note

The default setting is to flood non-matching packets. To restrict ARP through the security appliance to only static entries, then set this command to **no-flood**.

For example, to enable ARP inspection on the outside interface, and to drop all non-matching ARP packets, enter the following command:

```
hostname(config)# arp-inspection outside enable no-flood
```

To view the current settings for ARP inspection on all interfaces, enter the **show arp-inspection** command.

Customizing the MAC Address Table

This section describes the MAC address table, and includes the following topics:

- [MAC Address Table Overview, page 22-3](#)
- [Adding a Static MAC Address, page 22-3](#)
- [Setting the MAC Address Timeout, page 22-3](#)
- [Disabling MAC Address Learning, page 22-4](#)
- [Viewing the MAC Address Table, page 22-4](#)

MAC Address Table Overview

The security appliance learns and builds a MAC address table in a similar way as a normal bridge or switch: when a device sends a packet through the security appliance, the security appliance adds the MAC address to its table. The table associates the MAC address with the source interface so that the security appliance knows to send any packets addressed to the device out the correct interface.

Because the security appliance is a firewall, if the destination MAC address of a packet is not in the table, the security appliance does not flood the original packet on all interfaces as a normal bridge does. Instead, it generates the following packets for directly connected devices or for remote devices:

- Packets for directly connected devices—The security appliance generates an ARP request for the destination IP address, so that the security appliance can learn which interface receives the ARP response.
- Packets for remote devices—The security appliance generates a ping to the destination IP address so that the security appliance can learn which interface receives the ping reply.

The original packet is dropped.

Adding a Static MAC Address

Normally, MAC addresses are added to the MAC address table dynamically as traffic from a particular MAC address enters an interface. You can add static MAC addresses to the MAC address table if desired. One benefit to adding static entries is to guard against MAC spoofing. If a client with the same MAC address as a static entry attempts to send traffic to an interface that does not match the static entry, then the security appliance drops the traffic and generates a system message.

To add a static MAC address to the MAC address table, enter the following command:

```
hostname(config)# mac-address-table static interface_name mac_address
```

The *interface_name* is the source interface.

Setting the MAC Address Timeout

The default timeout value for dynamic MAC address table entries is 5 minutes, but you can change the timeout. To change the timeout, enter the following command:

```
hostname(config)# mac-address-table aging-time timeout_value
```

The *timeout_value* (in minutes) is between 5 and 720 (12 hours). 5 minutes is the default.

Disabling MAC Address Learning

By default, each interface automatically learns the MAC addresses of entering traffic, and the security appliance adds corresponding entries to the MAC address table. You can disable MAC address learning if desired, however, unless you statically add MAC addresses to the table, no traffic can pass through the security appliance.

To disable MAC address learning, enter the following command:

```
hostname(config)# mac-learn interface_name disable
```

The **no** form of this command reenables MAC address learning. The **clear configure mac-learn** command reenables MAC address learning on all interfaces.

Viewing the MAC Address Table

You can view the entire MAC address table (including static and dynamic entries for both interfaces), or you can view the MAC address table for an interface. To view the MAC address table, enter the following command:

```
hostname# show mac-address-table [interface_name]
```

The following is sample output from the **show mac-address-table** command that shows the entire table:

```
hostname# show mac-address-table
interface      mac address      type      Time Left
-----
outside        0009.7cbe.2100   static    -
inside         0010.7cbe.6101   static    -
inside         0009.7cbe.5101   dynamic   10
```

The following is sample output from the **show mac-address-table** command that shows the table for the inside interface:

```
hostname# show mac-address-table inside
interface      mac address      type      Time Left
-----
inside        0010.7cbe.6101   static    -
inside        0009.7cbe.5101   dynamic   10
```

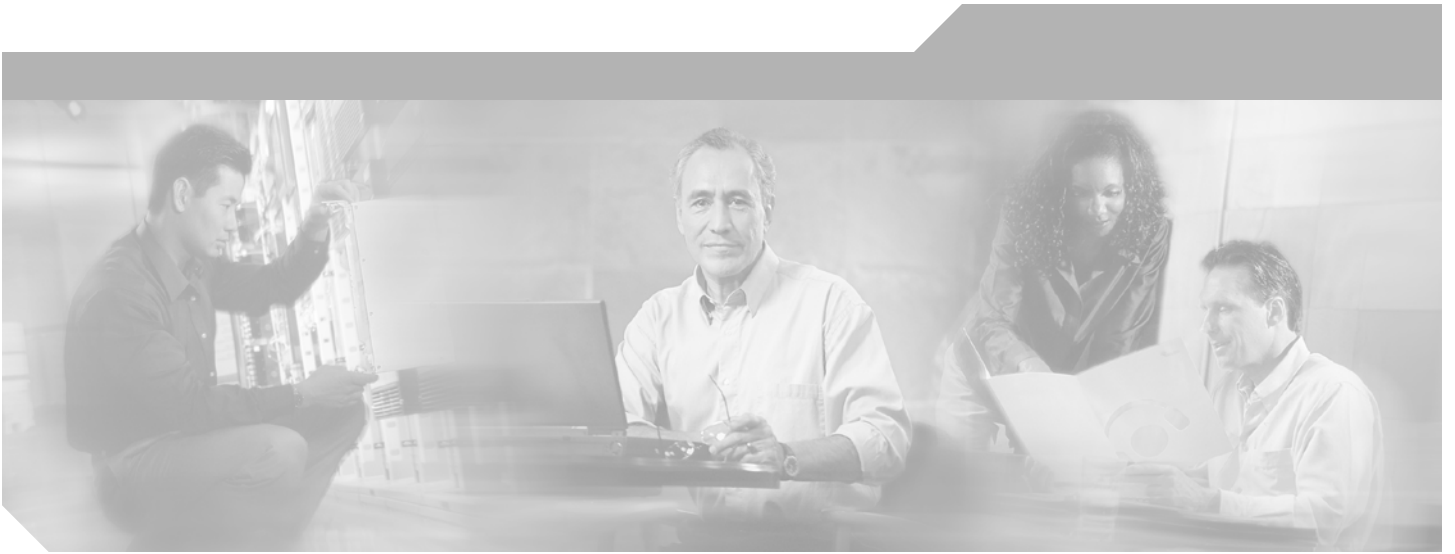

PART 3

Configuring VPN





Configuring IPsec and ISAKMP

This chapter describes how to configure the IPsec and ISAKMP standards to build virtual private networks. It includes the following sections:

- [Tunneling Overview, page 23-1](#)
- [IPsec Overview, page 23-2](#)
- [Configuring ISAKMP, page 23-2](#)
- [Configuring Certificate Group Matching, page 23-9](#)
- [Configuring IPsec, page 23-11](#)
- [Clearing Security Associations, page 23-27](#)
- [Clearing Crypto Map Configurations, page 23-27](#)

Tunneling Overview

Tunneling makes it possible to use a public TCP/IP network, such as the Internet, to create secure connections between remote users and a private corporate network. Each secure connection is called a tunnel.

The security appliance uses the ISAKMP and IPsec tunneling standards to build and manage tunnels. ISAKMP and IPsec accomplish the following:

- Negotiate tunnel parameters
- Establish tunnels
- Authenticate users and data
- Manage security keys
- Encrypt and decrypt data
- Manage data transfer across the tunnel
- Manage data transfer inbound and outbound as a tunnel endpoint or router

The security appliance functions as a bidirectional tunnel endpoint. It can receive plain packets from the private network, encapsulate them, create a tunnel, and send them to the other end of the tunnel where they are unencapsulated and sent to their final destination. It can also receive encapsulated packets from the public network, unencapsulate them, and send them to their final destination on the private network.

IPsec Overview

IPsec provides authentication and encryption services to prevent unauthorized viewing or modification of data within your network or as it travels over an unprotected network, such as the public Internet. Our implementation of the IPsec standard uses the ESP security protocol to provide authentication, encryption, and anti-replay services.

The security appliance uses IPsec for LAN-to-LAN VPN connections, and provides the option of using IPsec for client-to-LAN VPN connections. In IPsec terminology, a “peer” is a remote-access client or another secure gateway. For both connection types, the security appliance supports only Cisco peers. Because we adhere to VPN industry standards, ASAs may work with other vendors' peers; however, we do not support them.

During tunnel establishment, the two peers negotiate security associations that govern authentication, encryption, encapsulation, and key management. These negotiations involve two phases: first, to establish the tunnel (the IKE SA); and second, to govern traffic within the tunnel (the IPsec SA).

A LAN-to-LAN VPN connects networks in different geographic locations. In IPsec LAN-to-LAN connections, the security appliance can function as initiator or responder. In IPsec client-to-LAN connections, the security appliance functions only as responder. Initiators propose SAs; responders accept, reject, or make counter-proposals—all in accordance with configured SA parameters. To establish a connection, both entities must agree on the SAs.

Configuring ISAKMP

This section describes the Internet Key Exchange protocol which is also called the Internet Security Association and Key Management Protocol. The security appliance IKE commands use ISAKMP as a keyword, which this guide echoes. ISAKMP works with IPsec to make VPNs more scalable. This section includes the following topics:

- [ISAKMP Overview, page 23-2](#)
- [Configuring ISAKMP Policies, page 23-5](#)
- [Enabling ISAKMP on the Outside Interface, page 23-6](#)
- [Disabling ISAKMP in Aggressive Mode, page 23-6](#)
- [Determining an ID Method for ISAKMP Peers, page 23-6](#)
- [Enabling IPsec over NAT-T, page 23-7](#)
- [Enabling IPsec over TCP, page 23-8](#)
- [Waiting for Active Sessions to Terminate Prior to Reboot, page 23-8](#)
- [Alerting Peers Before Disconnecting, page 23-9](#)

ISAKMP Overview

IKE, also called ISAKMP, is the negotiation protocol that lets two hosts agree on how to build an IPsec security association. ISAKMP separates negotiation into two phases: Phase 1 and Phase 2.

Phase 1 creates the first tunnel, which protects later ISAKMP negotiation messages. Phase 2 creates the tunnel that protects data.

To set the terms of the ISAKMP negotiations, you create an ISAKMP policy, which includes the following:

- An authentication method, to ensure the identity of the peers.
- An encryption method, to protect the data and ensure privacy.
- A Hashed Message Authentication Codes (HMAC) method to ensure the identity of the sender, and to ensure that the message has not been modified in transit.
- A Diffie-Hellman group to determine the strength of the encryption-key-determination algorithm. The security appliance uses this algorithm to derive the encryption and hash keys.
- A limit for how long the security appliance uses an encryption key before replacing it.

Table 23-1 provides information about the ISAKMP policy keywords and their values.

Table 23-1 ISAKMP Policy Keywords for CLI Commands

Command	Keyword	Meaning	Description
isakmp policy authentication	rsa-sig	A digital certificate with keys generated by the RSA signatures algorithm	Specifies the authentication method the security appliance uses to establish the identity of each IPsec peer.
	dsa-sig	A digital certificate with keys generated by the DSA signatures algorithm	Specifies Digital Signature Algorithm signatures as the authentication method.
	pre-share (default)	Preshared keys	Preshared keys do not scale well with a growing network but are easier to set up in a small network.
isakmp policy encryption	des	56-bit DES-CBC	Specifies the symmetric encryption algorithm that protects data transmitted between two IPsec peers. The default is 168-bit Triple DES.
	3des (default)	168-bit Triple DES	
	aes aes-192 aes-256		The Advanced Encryption Standard supports key lengths of 128, 192, 256 bits.
isakmp policy hash	sha (default)	SHA-1 (HMAC variant)	Specifies the hash algorithm used to ensure data integrity. It ensures that a packet comes from where it says it comes from, and that it has not been modified in transit.
	md5	MD5 (HMAC variant)	The default is SHA-1. MD5 has a smaller digest and is considered to be slightly faster than SHA-1. A successful (but extremely difficult) attack against MD5 has occurred; however, the HMAC variant IKE uses prevents this attack.

Table 23-1 ISAKMP Policy Keywords for CLI Commands (continued)

Command	Keyword	Meaning	Description
isakmp policy group	1	Group 1 (768-bit)	Specifies the Diffie-Hellman group identifier, which the two IPsec peers use to derive a shared secret without transmitting it to each other.
	2 (default)	Group 2 (1024-bit)	
	5	Group 5 (1536-bit)	With the exception of Group 7, the lower the Diffie-Hellman group no., the less CPU time it requires to execute. The higher the Diffie-Hellman group no., the greater the security. Cisco VPN Client Version 3.x or higher requires a minimum of Group 2. (If you configure DH Group 1, the Cisco VPN Client cannot connect.) AES support is available on security appliances licensed for VPN-3DES only. To support the large key sizes required by AES, ISAKMP negotiation should use Diffie-Hellman (DH) Group 5. Designed for devices with low processing power, such as PDAs and mobile telephones, Group 7 provides the greatest security. The Certicom Movian Client requires Group 7.
	7	Group 7 (Elliptical curve field size is 163 bits.)	
isakmp policy lifetime	integer value (86400 = default)	120 to 2147483647 seconds	Specifies the SA lifetime. The default is 86,400 seconds or 24 hours. As a general rule, a shorter lifetime provides more secure ISAKMP negotiations (up to a point). However, with shorter lifetimes, the security appliance sets up future IPsec SAs more quickly.

Each configuration supports a maximum of 20 ISAKMP policies, each with a different set of values. Assign a unique priority to each policy you create. The lower the priority number, the higher the priority.

When ISAKMP negotiations begin, the peer that initiates the negotiation sends all of its policies to the remote peer, and the remote peer tries to find a match. The remote peer checks all of the peer's policies against each of its configured policies in priority order (highest priority first) until it discovers a match.

A match exists when both policies from the two peers contain the same encryption, hash, authentication, and Diffie-Hellman parameter values, and when the remote peer policy specifies a lifetime less than or equal to the lifetime in the policy the initiator sent. If the lifetimes are not identical, the security appliance uses the shorter lifetime. If no acceptable match exists, ISAKMP refuses negotiation and the SA is not established.

There is an implicit trade-off between security and performance when you choose a specific value for each parameter. The level of security the default values provide is adequate for the security requirements of most organizations. If you are interoperating with a peer that supports only one of the values for a parameter, your choice is limited to that value.

**Note**

New ASA configurations do not have a default ISAKMP policy.

Configuring ISAKMP Policies

To configure ISAKMP policies, in global configuration mode, use the **isakmp policy** command with its various arguments. The syntax for ISAKMP policy commands is as follows:

```
isakmp policy priority attribute_name [attribute_value | integer]
```

You must include the priority in each of the ISAKMP commands. The priority number uniquely identifies the policy, and determines the priority of the policy in ISAKMP negotiations.

To enable and configure ISAKMP, complete the following steps, using the examples as a guide:



Note

If you do not specify a value for a given policy parameter, the default value applies.

-
- Step 1** Specify the encryption algorithm. The default is Triple DES. This example sets encryption to DES.
- ```
isakmp policy priority encryption [aes | aes-192 | aes-256 | des | 3des]
```
- For example:
- ```
hostname(config)# isakmp policy 2 encryption des
```
- Step 2** Specify the hash algorithm. The default is SHA-1. This example configures MD5.
- ```
isakmp policy priority hash [md5 | sha]
```
- For example:
- ```
hostname(config)# isakmp policy 2 hash md5
```
- Step 3** Specify the authentication method. The default is preshared keys. This example configures RSA signatures.
- ```
isakmp policy priority authentication [pre-share | dsa-sig | rsa-sig]
```
- For example:
- ```
hostname(config)# isakmp policy 2 authentication rsa-sig
```
- Step 4** Specify the Diffie-Hellman group identifier. The default is Group 2. This example configures Group 5.
- ```
isakmp policy priority group [1 | 2 | 5 | 7]
```
- For example:
- ```
hostname(config)# isakmp policy 2 group 5
```
- Step 5** Specify the SA lifetime. This examples sets a lifetime of 4 hours (14400 seconds). The default is 86400 seconds (24 hours).
- ```
isakmp policy priority lifetime seconds
```
- For example:
- ```
hostname(config)# isakmp policy 2 lifetime 14400
```
-

Enabling ISAKMP on the Outside Interface

You must enable ISAKMP on the interface that terminates the VPN tunnel. Typically this is the outside, or public interface.

To enable ISAKMP, enter the following command:

```
isakmp enable interface-name
```

For example:

```
hostname(config)# isakmp enable outside
```

Disabling ISAKMP in Aggressive Mode

Phase 1 ISAKMP negotiations can use either main mode or aggressive mode. Both provide the same services, but aggressive mode requires only two exchanges between the peers totaling 3 messages, rather than three exchanges totaling 6 messages. Aggressive mode is faster, but does not provide identity protection for the communicating parties. Therefore, the peers must exchange identification information prior to establishing a secure SA. Aggressive mode is enabled by default.

- Main mode is slower, using more exchanges, but it protects the identities of the communicating peers.
- Aggressive mode is faster, but does not protect the identities of the peers.

To disable ISAKMP in aggressive mode, enter the following command:

```
isakmp am-disable
```

For example:

```
hostname(config)# isakmp am-disable
```

If you have disabled aggressive mode, and want to revert to back to it, use the **no** form of the command. For example:

```
hostname(config)# no isakmp am-disable
```



Note

Disabling aggressive mode prevents Cisco VPN clients from using preshared key authentication to establish tunnels to the security appliance. However, they may use certificate-based authentication (that is, ASA or RSA) to establish tunnels.

Determining an ID Method for ISAKMP Peers

During Phase I ISAKMP negotiations the peers must identify themselves to each other. You can choose the identification method from the following options:

Address	Uses the IP addresses of the hosts exchanging ISAKMP identity information
Automatic	Determines ISAKMP negotiation by connection type: <ul style="list-style-type: none"> • IP address for preshared key • Cert Distinguished Name for certificate authentication

Hostname	Uses the fully qualified domain name of the hosts exchanging ISAKMP identity information (default). This name comprises the hostname and the domain name
Key ID	Uses the string the remote peer uses to look up the preshared key

The security appliance uses the Phase I ID to send to the peer. This is true for all VPN scenarios except LAN-to-LAN connections in main mode that authenticate with preshared keys.

The default setting is hostname.

To change the peer identification method, enter the following command:

```
isakmp identity {address | hostname | key-id id-string | auto}
```

For example, the following command sets the identification method to automatic:

```
hostname(config)# isakmp identity auto
```

Enabling IPsec over NAT-T

NAT-T lets IPsec peers establish a connection through a NAT device. It does this by encapsulating IPsec traffic in UDP datagrams, using port 4500, thereby providing NAT devices with port information. NAT-T auto-detects any NAT devices, and only encapsulates IPsec traffic when necessary. This feature is disabled by default.

- The security appliance can simultaneously support standard IPsec, IPsec over TCP, NAT-T, and IPsec over UDP, depending on the client with which it is exchanging data.
- When both NAT-T and IPsec over UDP are enabled, NAT-T takes precedence.
- When enabled, IPsec over TCP takes precedence over all other connection methods.
- When you enable NAT-T, the security appliance automatically opens port 4500 on all IPsec enabled interfaces.

The security appliance supports multiple IPsec peers behind a single NAT/PAT device operating in one of the following networks, but not both:

- LAN-to-LAN
- Remote access

In a mixed environment, the remote access tunnels fail the negotiation because all peers appear to be coming from the same public IP address, that of the NAT device. Also, remote access tunnels fail in a mixed environment because they often use the same name as the LAN-to-LAN tunnel group (that is, the IP address of the NAT device). This match can cause negotiation failures among multiple peers in a mixed LAN-to-LAN and remote access network of peers behind the NAT device.

Using NAT-T

To use NAT-T you must perform three tasks:

1. Enable IPsec over NAT-T globally on the security appliance.
2. Select the “before-fragmentation” option for the IPsec fragmentation policy. This option lets traffic travel across NAT devices that do not support IP fragmentation. It does not impede the operation of NAT devices that do support IP fragmentation.
3. Set a keepalive value, which can be from 10 to 3600 seconds. The default is 20 seconds.

To enable NAT-T globally on the security appliance, enter the following command:

```
isakmp nat-traversal natkeepalive
```

This example enables NAT-T and sets the keepalive to one hour.

```
hostname(config)# isakmp nat-traversal 3600
```

Enabling IPsec over TCP

IPsec over TCP enables a Cisco VPN client to operate in an environment in which standard ESP or ISAKMP cannot function, or can function only with modification to existing firewall rules. IPsec over TCP encapsulates both the ISAKMP and IPsec protocols within a TCP-like packet, and enables secure tunneling through both NAT and PAT devices and firewalls. This feature is disabled by default.



Note

This feature does not work with proxy-based firewalls.

IPsec over TCP works with remote access clients. You enable it globally, and it works on all ISAKMP enabled interfaces. It is a client to security appliance feature only. It does not work for LAN-to-LAN connections.

- The security appliance can simultaneously support standard IPsec, IPsec over TCP, NAT-Traversal, and IPsec over UDP, depending on the client with which it is exchanging data.
- The VPN 3002 hardware client, which supports one tunnel at a time, can connect using standard IPsec, IPsec over TCP, NAT-Traversal, or IPsec over UDP.
- When enabled, IPsec over TCP takes precedence over all other connection methods.

You enable IPsec over TCP on both the security appliance and the client to which it connects.

You can enable IPsec over TCP for up to 10 ports that you specify. If you enter a well-known port, for example port 80 (HTTP) or port 443 (HTTPS), the system displays a warning that the protocol associated with that port no longer works on the public interface. The consequence is that you can no longer use a browser to manage the security appliance through the public interface. To solve this problem, reconfigure the HTTP/HTTPS management to different ports.

The default port is 10000.

You must configure TCP port(s) on the client as well as on the security appliance. The client configuration must include at least one of the ports you set for the security appliance.

To enable IPsec over TCP globally on the security appliance, enter the following command:

```
isakmp ipsec-over-tcp [port port 1...port0]
```

This example enables IPsec over TCP on port 45:

```
hostname(config)# isakmp ctcp port 45
```

Waiting for Active Sessions to Terminate Prior to Reboot

You can schedule a security appliance reboot to occur only when all active sessions have terminated voluntarily. This feature is disabled by default.

To enable waiting for all active sessions to voluntarily terminate before the security appliance reboots, enter the following command:

```
isakmp reload-wait
```

For example:

```
hostname(config)# isakmp reload-wait
```

Use the **reload** command to reboot the security appliance. If you set the **reload-wait** command, you can use the **reload quick** command to override the **reload-wait** setting. The **reload** and **reload-wait** commands are available in Privileged EXEC mode; neither includes the **isakmp** prefix.

Alerting Peers Before Disconnecting

Remote access or LAN-to-LAN sessions can drop for several reasons, such as: a security appliance shutdown or reboot, session idle timeout, maximum connection time exceeded, or administrator cut-off.

The security appliance can notify qualified peers (in LAN-to-LAN configurations), Cisco VPN Clients and VPN 3002 hardware clients of sessions that are about to be disconnected. The peer or client receiving the alert decodes the reason and displays it in the event log or in a pop-up panel. This feature is disabled by default.

Qualified clients and peers include the following:

- Security appliances with Alerts enabled.
- Cisco VPN clients running version 4.0 or later software (no configuration required).
- VPN 3002 hardware clients running version 4.0 or later software, and with Alerts enabled.
- VPN 3000 Series concentrators running version 4.0 or later software, with Alerts enabled.

To enable disconnect notification to IPsec peers, enter the **isakmp disconnect-notify command**.

For example:

```
hostname(config)# isakmp disconnect-notify
```

Configuring Certificate Group Matching

Tunnel groups define user connection terms and permissions. Certificate group matching lets you match a user to a tunnel group using either the Subject DN or Issuer DN of the user certificate.

To match users to tunnel groups based on these fields of the certificate, you must first create rules that define a matching criteria, and then associate each rule with the desired tunnel group.

To create a certificate map, use the **crypto ca certificate map** command. To define a tunnel group, use the **tunnel-group** command.

You must also configure a certificate group matching policy that sets one of the following methods for identifying the permission groups of certificate users:

- Match the group from the rules
- Match the group from the organizational unit (OU) field
- Use a default group for all certificate users

You can use any or all of these methods.

Creating a Certificate Group Matching Rule and Policy

To configure the policy and rules by which certificate-based ISAKMP sessions map to tunnel groups, and to associate the certificate map entries with tunnel groups, enter the **tunnel-group-map** command in global configuration mode.

The syntax follows:

```
tunnel-group-map enable { rules | ou | ike-id | peer ip }
```

```
tunnel-group-map [rule-index] enable policy
```

<i>policy</i>	<p>Specifies the policy for deriving the tunnel group name from the certificate. <i>Policy</i> can be one of the following:</p> <p>ike-id—Indicates that if a tunnel-group is not determined based on a rule lookup or taken from the ou, then the certificate-based ISAKMP sessions are mapped to a tunnel group based on the content of the phase1 ISAKMP ID.</p> <p>ou—Indicates that if a tunnel-group is not determined based on a rule lookup, then use the value of the OU in the subject distinguished name (DN).</p> <p>peer-ip—Indicates that if a tunnel-group is not determined based on a rule lookup or taken from the ou or ike-id methods, then use the peer IP address.</p> <p>rules—Indicates that the certificate-based ISAKMP sessions are mapped to a tunnel group based on the certificate map associations configured by this command.</p>
<i>rule index</i>	<p>Optional. Refers to parameters specified by the crypto ca certificate map command. The values are 1 to 65535.</p>

Be aware of the following:

- You can invoke this command multiple times as long as each invocation is unique and you do not reference a map index more than once.
- Rules cannot be longer than 255 characters.
- You can assign multiple rules to the same group. To do that, you add the rule priority and group first. Then you define as many criteria statements as you need for each group. When multiple rules are assigned to the same group, a match results for the first rule that tests true.
- Create a single rule if you want to require all criteria to match before assigning a user to a specific tunnel group. Requiring all criteria to match is equivalent to a logical AND operation. Alternatively, create one rule for each criterion if you want to require that only one match before assigning a user to a specific tunnel group. Requiring only one criterion to match is equivalent to a logical OR operation.

The following example enables mapping of certificate-based ISAKMP sessions to a tunnel group based on the content of the phase1 ISAKMP ID:

```
hostname(config)# tunnel-group-map enable ike-id
hostname(config)#
```

The following example enables mapping of certificate-based ISAKMP sessions to a tunnel group based on the IP address of the peer:

```
hostname(config)# tunnel-group-map enable peer-ip
hostname(config)#
```

The following example enables mapping of certificate-based ISAKMP sessions based on the organizational unit (OU) in the subject distinguished name (DN):

```
hostname(config)# tunnel-group-map enable ou
hostname(config)#
```

The following example enables mapping of certificate-based ISAKMP sessions based on established rules:

```
hostname(config)# tunnel-group-map enable rules
hostname(config)#
```

Using the Tunnel-group-map default-group Command

This command specifies a default tunnel group to use when the name cannot be derived by other configured methods.

The syntax is **tunnel-group-map** [*rule-index*] **default-group** *tunnel-group-name* where the *rule-index* is the priority for the rule, and *tunnel-group name* must be for a tunnel group that already exists.

Configuring IPsec

This section provides background information about IPsec and describes the procedures required to configure the security appliance when using IPsec to implement a VPN. It contains the following topics:

- [Understanding IPsec Tunnels, page 23-11](#)
- [Understanding Transform Sets, page 23-12](#)
- [Defining Crypto Maps, page 23-12](#)
- [Applying Crypto Maps to Interfaces, page 23-20](#)
- [Using Interface Access Lists, page 23-20](#)
- [Changing IPsec SA Lifetimes, page 23-22](#)
- [Creating a Basic IPsec Configuration, page 23-23](#)
- [Using Dynamic Crypto Maps, page 23-24](#)
- [Providing Site-to-Site Redundancy, page 23-26](#)
- [Viewing an IPsec Configuration, page 23-26](#)

Understanding IPsec Tunnels

IPsec tunnels are sets of SAs that the security appliance establishes between peers. The SAs define the protocols and algorithms to apply to sensitive data, and also specify the keying material the peers use. IPsec SAs control the actual transmission of user traffic. SAs are unidirectional, but are generally established in pairs (inbound and outbound).

The peers negotiate the settings to use for each SA. Each SA consists of the following:

- Transform sets
- Crypto maps
- Access lists

- Tunnel groups
- Pre fragmentation policies

Understanding Transform Sets

A transform set is a combination of security protocols and algorithms that define how the security appliance protects data. You create multiple transform sets, and then specify up to six of them in a crypto map.

During IPsec SA negotiations, the peers must identify a transform set that is the same at both peers. The security appliance then applies the matching transform set to create an SA that protects data flows in the access list for that crypto map.

If you change a transform set definition, the security appliance tears down the tunnel. See “[Clearing Security Associations](#)” for further information.



Note

If you clear or delete the only element in a transform set, the security appliance automatically removes the crypto map references to it.

Defining Crypto Maps

Crypto maps define the IPsec policy to be negotiated in the IPsec SA. They include the following:

- Access list to identify the packets that the IPsec connection permits and protects.
- Peer identification
- Local address for the IPsec traffic (See “[Applying Crypto Maps to Interfaces](#)” for more details.)
- Up to six transform sets with which to attempt to match the peer security settings.

A *crypto map set* consists of one or more crypto maps that have the same map name. You create a crypto map set when you create its first crypto map. The following command syntax creates or adds to a crypto map:

```
crypto map map-name seq-num match address access-list-name
```

You can continue to enter this command to add crypto maps to the crypto map set. In the following example, “mymap” is the name of the crypto map set to which you might want to add crypto maps:

```
crypto map mymap 10 match address 101
```

Among crypto maps with the same name, the *sequence number* (seq-num) shown in the syntax above distinguishes one from the other. The sequence number assigned to a crypto map also determines its priority among the other crypto maps within a crypto map set. The lower the sequence number, the higher the priority. After you assign a crypto map set to an interface, the security appliance evaluates all IP traffic passing through the interface against the crypto maps in the set, beginning with the crypto map with the lowest sequence number.

The *access control list* (ACL) assigned to a crypto map consists of all of the access control entries (ACEs) that have the same access-list-name, as shown in the following command syntax:

```
access-list access-list-name {deny | permit} ip source source-netmask destination destination-netmask
```

Each ACL consists of one or more ACEs that have the same access-list-name. You create an ACL when you create its first ACE. The following command syntax creates or adds to an ACL:

```
access-list access-list-name {deny | permit} ip source source-netmask destination destination-netmask
```

In the following example, the security appliance applies the IPsec protections assigned to the crypto map to all traffic flowing from the 10.0.0.0 subnet to the 10.1.1.0 subnet.

```
access-list 101 permit ip 10.0.0.0 255.255.255.0 10.1.1.0 255.255.255.0
```

The crypto map that matches the packet determines the security settings used in the SA negotiations. If the local security appliance initiates the negotiation, it uses the policy specified in the static crypto map to create the offer to send to the specified peer. If the peer initiates the negotiation, the security appliance attempts to match the policy to a static crypto map, and if that fails, any dynamic crypto maps in the crypto map set, to decide whether to accept or reject the peer offer.

For two peers to succeed in establishing an SA, they must have at least one compatible crypto map. To be compatible, a crypto map must meet the following criteria:

- The crypto map must contain compatible crypto ACLs (for example, mirror image ACLs). If the responding peer uses dynamic crypto maps, so must the security appliance as a requirement to apply IPsec.
- Each crypto map identifies the other peer (unless the responding peer uses dynamic crypto maps).
- The crypto maps have at least one transform set in common.

You can apply only one crypto map set to a single interface. Create multiple crypto maps for a particular interface on the security appliance if any of the following conditions exist:

- You want specific peers to handle different data flows.
- You want different IPsec security to apply to different types of traffic.

For example, create a crypto map and assign an ACL to identify traffic between two subnets and assign one transform set. Create another crypto map with a different ACL to identify traffic between another two subnets and apply a transform set with different VPN parameters.

If you create more than one crypto map for an interface, specify a sequence number (seq-num) for each map entry to determine its priority within the crypto map set.

Each ACE contains a permit or deny statement. [Table 23-2](#) explains the special meanings of permit and deny ACEs in ACLs applied to crypto maps.

Table 23-2 *Special Meanings of Permit and Deny in Crypto Access Lists Applied to Outbound Traffic*

Result of Crypto Map Evaluation	Response
Match criterion in an ACE containing a permit statement	Halt further evaluation of the packet against the remaining ACEs in the crypto map set, and evaluate the packet security settings against those in the transform sets assigned to the crypto map. After matching the security settings to those in a transform set, the security appliance applies the associated IPsec settings. Typically for outbound traffic, this means that it decrypts, authenticates, and routes the packet.
Match criterion in an ACE containing a deny statement	Interrupt further evaluation of the packet against the remaining ACEs in the crypto map under evaluation, and resume evaluation against the ACEs in the next crypto map, as determined by the next seq-num assigned to it.
Fail to match all tested permit ACEs in the crypto map set	Route the packet without encrypting it.

ACEs containing deny statements filter out outbound traffic that does not require IPsec protection (for example, routing protocol traffic). Therefore, insert initial deny statements to filter outbound traffic that should not be evaluated against permit statements in a crypto access list.

For an inbound, encrypted packet, the security appliance uses the source address and ESP SPI to determine the decryption parameters. After the security appliance decrypts the packet, it compares the inner header of the decrypted packet to the permit ACEs in the ACL associated with the packet's SA. If the inner header fails to match the proxy, the security appliance drops the packet. If the inner header matches the proxy, the security appliance routes the packet.

When comparing the inner header of an inbound packet that was not encrypted, the security appliance ignores all deny rules because they would prevent the establishment of a Phase 2 SA.

**Note**

To route inbound, unencrypted traffic as clear text, insert deny ACEs before permit ACEs.

Figure 23-1 shows an example LAN-to-LAN network of security appliances.

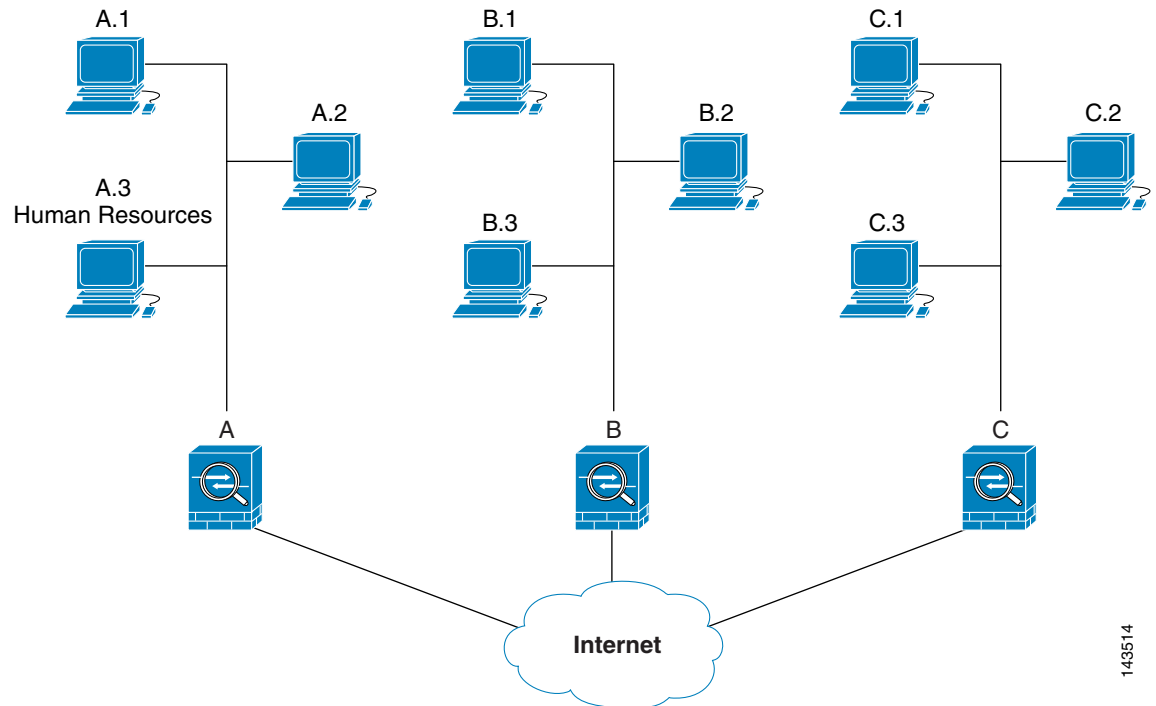
Figure 23-1 Effect of Permit and Deny ACEs on Traffic (Conceptual Addresses)

143514

The simple address notation shown in this figure and used in the following explanation is an abstraction. An example with real IP addresses follows the explanation.

The objective in configuring Security Appliances A, B, and C in this example LAN-to-LAN network is to permit tunneling of all traffic originating from one of the hosts shown in [Figure 23-1](#) and destined for one of the other hosts. However, because traffic from Host A.3 contains sensitive data from the Human Resources department, it requires strong encryption and more frequent rekeying than the other traffic. So we want to assign a special transform set for traffic from Host A.3.

To configure Security Appliance A for outbound traffic, we create two crypto maps, one for traffic from Host A.3 and the other for traffic from the other hosts in Network A, as shown in the following example:

```
Crypto Map Seq_No_1
  deny packets from A.3 to B
  deny packets from A.3 to C
  permit packets from A to B
  permit packets from A to C
Crypto Map Seq_No_2
  permit packets from A.3 to B
  permit packets from A.3 to C
```

After creating the ACLs, you assign a transform set to each crypto map to apply the required IPsec to each matching packet.

Cascading ACLs involves the insertion of deny ACEs to bypass evaluation against an ACL and resume evaluation against a subsequent ACL in the crypto map set. Because you can associate each crypto map with different IPsec settings, you can use deny ACEs to exclude special traffic from further evaluation in the corresponding crypto map, and match the special traffic to permit statements in another crypto map to provide or require different security. The sequence number assigned to the crypto ACL determines its position in the evaluation sequence within the crypto map set.

Figure 23-2 shows the cascading ACLs created from the conceptual ACEs above. Each symbol in the figure represents the following:





	Crypto map within a crypto map set.
	(Gap in a straight line) Exit from a crypto map when a packet matches an ACE.
	Packet that fits the description of one ACE. Each size ball represents a different packet matching the respective ACE in the figure. The differences in size merely represent differences in the source and destination of each packet.
	Redirection to the next crypto map in the crypto map set.
	Response when a packet either matches an ACE or fails to match all of the permit ACEs in a crypto map set.

Figure 23-2 Cascading ACLs in a Crypto Map Set

Security Appliance A evaluates a packet originating from Host A.3 until it matches a permit ACE and attempts to assign the IPsec security associated with the crypto map. Whenever the packet matches a deny ACE, the security appliance ignores the remaining ACEs in the crypto map and resumes evaluation against the next crypto map, as determined by the sequence number assigned to it. So in the example, if Security Appliance A receives a packet from Host A.3, it matches the packet to a deny ACE in the first crypto map and resumes evaluation of the packet against the next crypto map. When it matches the packet to the permit ACE in that crypto map, it applies the associated IPsec security (strong encryption and frequent rekeying).

To complete the security appliance configuration in the example network, we assign mirror crypto maps to Security Appliances B and C. However, because security appliances ignore deny ACEs when evaluating inbound, encrypted traffic, we can omit the mirror equivalents of the deny A.3 B and deny A.3 C ACEs, and therefore omit the mirror equivalents of Crypto Map 2. So the configuration of cascading ACLs in Security Appliances B and C is unnecessary.

Table 23-3 shows the ACLs assigned to the crypto maps configured for all three security appliances in Figure 23-1.

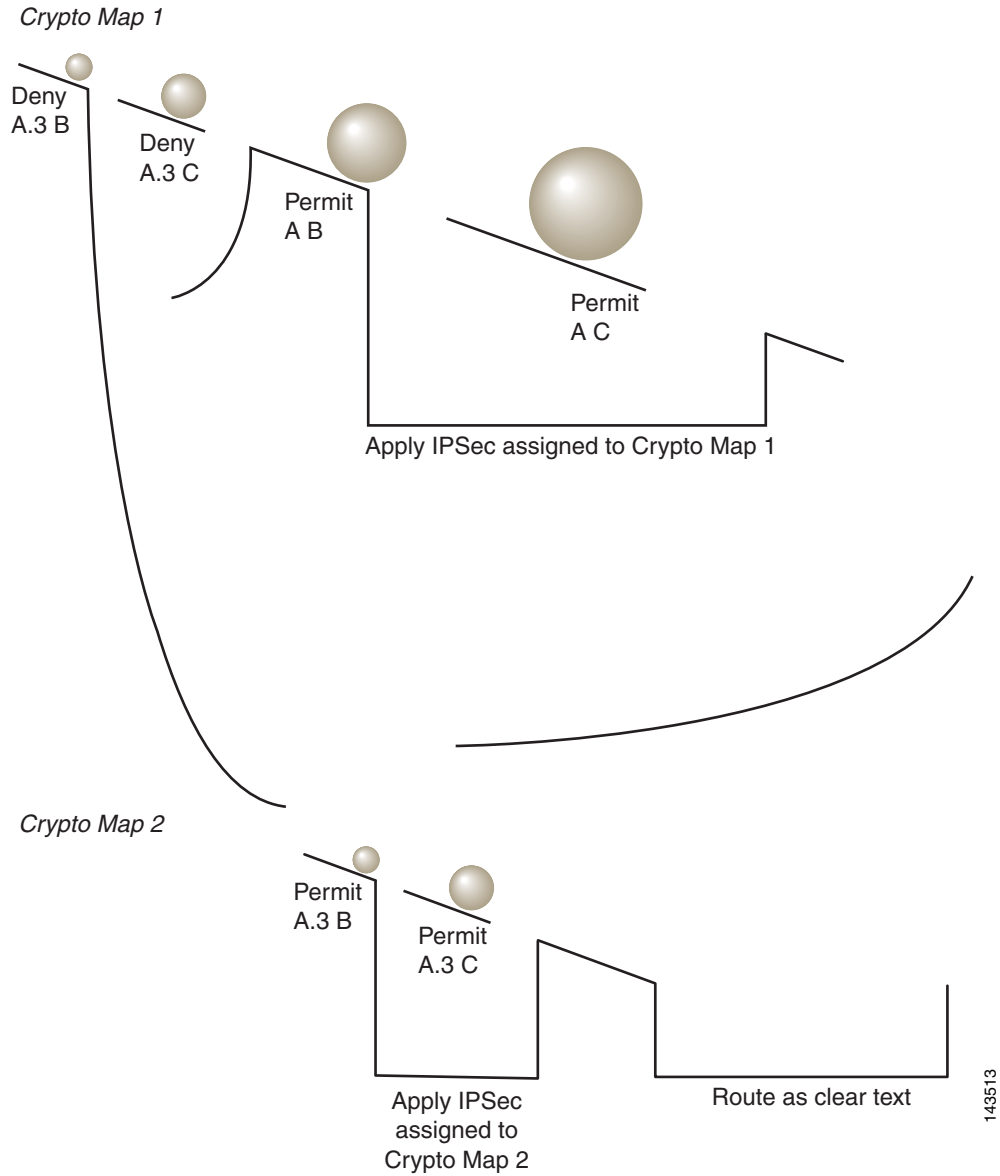
Table 23-3 Example Permit and Deny Statements (Conceptual)

Security Appliance A		Security Appliance B		Security Appliance C	
Crypto Map Sequence No.	ACE Pattern	Crypto Map Sequence No.	ACE Pattern	Crypto Map Sequence No.	ACE Pattern
1	deny A.3 B	1	permit B A	1	permit C A
	deny A.3 C				
	permit A B				
	permit A C		permit B C		permit C B
2	permit A.3 B				
	permit A.3 C				

Figure 23-3 maps the conceptual addresses shown in Figure 23-1 to real IP addresses.

Figure 23-3 Effect of Permit and Deny ACEs on Traffic (Real Addresses)

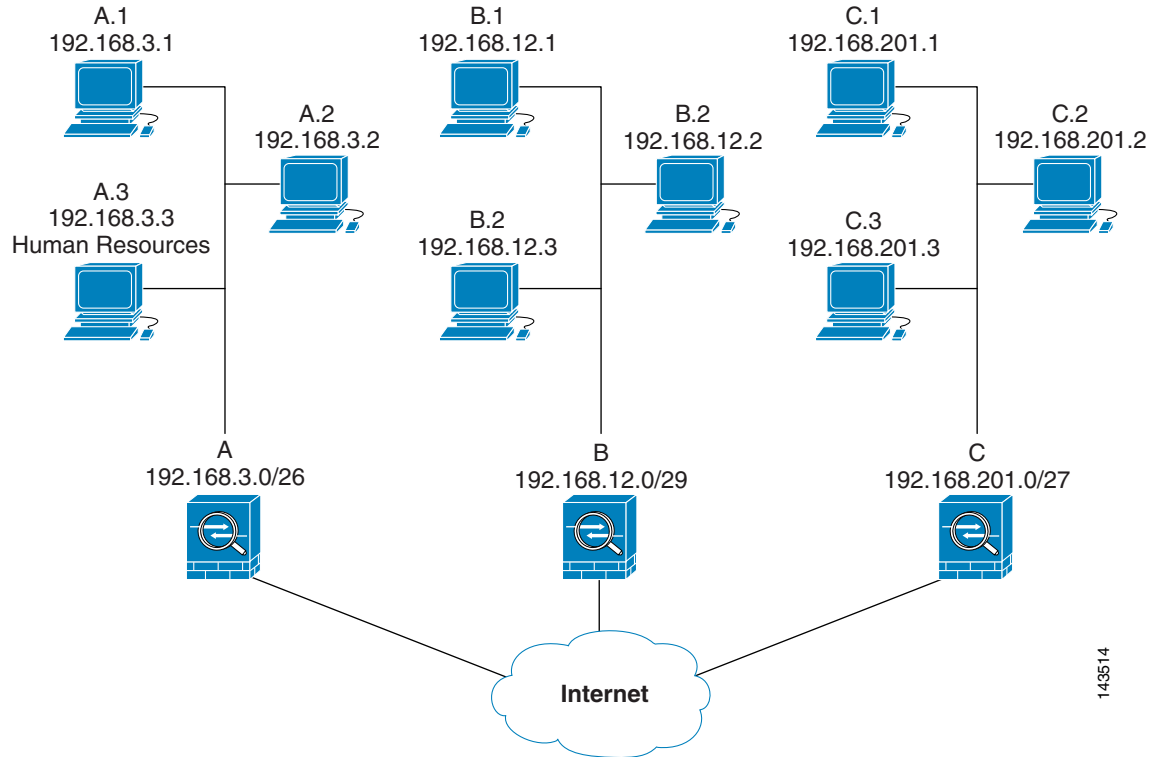

143514

The tables that follow combine the IP addresses shown in [Figure 23-3](#) to the concepts shown in [Table 23-3](#). The real ACEs shown in these tables ensure that all IPsec packets under evaluation within this network receive the proper IPsec settings.

Table 23-4 Example Permit and Deny Statements for Security Appliance A

Security Appliance	Crypto Map Sequence No.	ACE Pattern	Real ACEs
A	1	deny A.3 B	deny 192.168.3.3 255.255.255.192 192.168.12.0 255.255.255.248
		deny A.3 C	deny 192.168.3.3 255.255.255.192 192.168.201.0 255.255.255.224
		permit A B	permit 192.168.3.0 255.255.255.192 192.168.12.0 255.255.255.248
		permit A C	permit 192.168.3.0 255.255.255.192 192.168.201.0 255.255.255.224
A	2	permit A.3 B	permit 192.168.3.3 255.255.255.192 192.168.12.0 255.255.255.248
		permit A.3 C	permit 192.168.3.3 255.255.255.192 192.168.201.0 255.255.255.224
B	None needed	permit B A	permit 192.168.12.0 255.255.255.248 192.168.3.0 255.255.255.192
		permit B C	permit 192.168.12.0 255.255.255.248 192.168.201.0 255.255.255.224
C	None needed	permit C A	permit 192.168.201.0 255.255.255.224 192.168.3.0 255.255.255.192
		permit C B	permit 192.168.201.0 255.255.255.224 192.168.12.0 255.255.255.248

You can apply the same reasoning shown in the example network to use cascading ACLs to assign different security settings to different hosts or subnets protected by a Cisco security appliance.

**Note**

By default, the security appliance does not support IPsec traffic destined for the same interface from which it enters. (Names for this type of traffic include U-turn, hub-and-spoke, and hairpinning.) However, you might want IPsec to support U-turn traffic. To do so, insert an ACE to permit traffic to and from the network. For example, to support U-turn traffic on Security Appliance B, add a conceptual “permit B B” ACE to ACL1. The actual ACE would be as follows:

```
permit 192.168.12.0 255.255.255.248 192.168.12.0 255.255.255.248
```

Applying Crypto Maps to Interfaces

You must assign a crypto map set to each interface through which IPsec traffic flows. The security appliance supports IPsec on all interfaces. Assigning the crypto map set to an interface instructs the security appliance to evaluate all the traffic against the crypto map set and to use the specified policy during connection or SA negotiation.

Assigning a crypto map to an interface also initializes run-time data structures, such as the SA database and the security policy database. Reassigning a modified crypto map to the interface resynchronizes the run-time data structures with the crypto map configuration. Also, adding new peers through the use of new sequence numbers and reassigning the crypto map does not tear down existing connections.

Using Interface Access Lists

By default, the security appliance lets IPsec packets bypass interface ACLs. If you want to apply interface access lists to IPsec traffic, use the **no** form of the **sysopt connection permit-ipsec** command.

The crypto map access list bound to the outgoing interface either permits or denies IPsec packets through the VPN tunnel. IPsec authenticates and deciphers packets that arrive from an IPsec tunnel, and subjects them to evaluation against the ACL associated with the tunnel.

Access lists define which IP traffic to protect. For example, you can create access lists to protect all IP traffic between two subnets or two hosts. (These access lists are similar to access lists used with the **access-group** command. However, with the **access-group** command, the access list determines which traffic to forward or block at an interface.)

Before the assignment to crypto maps, the access lists are not specific to IPsec. Each crypto map references the access lists and determines the IPsec properties to apply to a packet if it matches a permit in one of the access lists.

Access lists assigned to IPsec crypto maps have four primary functions:

- Select outbound traffic to be protected by IPsec (permit = protect).
- Trigger an ISAKMP negotiation for data travelling without an established SA.
- Process inbound traffic to filter out and discard traffic that should have been protected by IPsec.
- Determine whether to accept requests for IPsec SAs when processing IKE negotiation from the peer. (Negotiation applies only to **ipsec-isakmp crypto map** entries.) The peer must “permit” a data flow associated with an **ipsec-isakmp crypto map** command entry to ensure acceptance during negotiation.

Regardless of whether the traffic is inbound or outbound, the security appliance evaluates traffic against the access lists assigned to an interface. You assign IPsec to an interface as follows:

-
- Step 1** Create the access lists to be used for IPsec.
 - Step 2** Map the lists to one or more crypto maps, using the same crypto map name.
 - Step 3** Map the transform sets to the crypto maps to apply IPsec to the data flows.
 - Step 4** Apply the crypto maps collectively as a “crypto map set” by assigning the crypto map name they share to the interface.
-

In [Figure 23-4](#), IPsec protection applies to traffic between Host 10.0.0.1 and Host 10.2.2.2 as the data exits the outside interface on Security Appliance A toward Host 10.2.2.2.

Figure 23-4 How Crypto Access Lists Apply to IPsec

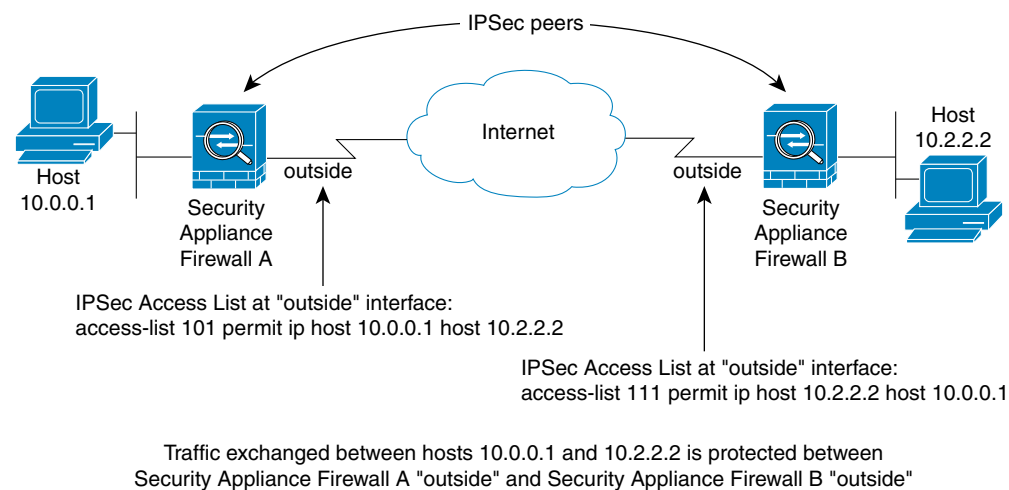

Security Appliance A evaluates traffic from Host 10.0.0.1 to Host 10.2.2.2, as follows:

- source = host 10.0.0.1
- dest = host 10.2.2.2

Security Appliance A also evaluates traffic from Host 10.2.2.2 to Host 10.0.0.1, as follows:

- source = host 10.2.2.2
- dest = host 10.0.0.1

The first permit statement that matches the packet under evaluation determines the scope of the IPsec SA.



Note

If you delete the only element in an access list, the security appliance also removes the associated crypto map.

If you modify an access list currently referenced by one or more crypto maps, use the **crypto map interface** command to re initialize the run-time SA database. See the **crypto map** command for more information.

We recommend that for every crypto access list specified for a static crypto map that you define at the local peer, you define a “mirror image” crypto access list at the remote peer. The crypto maps should also support common transforms and refer to the other system as a peer. This ensures correct processing of IPsec by both peers.

**Note**

Every static crypto map must define an access list and an IPsec peer. If either is missing, the crypto map is incomplete and the security appliance drops any traffic that it has not already matched to an earlier, complete crypto map. Use the **show conf** command to ensure that every crypto map is complete. To fix an incomplete crypto map, remove the crypto map, add the missing entries, and reapply it.

We discourage the use of the **any** keyword to specify source or destination addresses in crypto access lists because they cause problems. We strongly discourage the **permit any any** command statement because it does the following:

- Protects all outbound traffic, including all protected traffic sent to the peer specified in the corresponding crypto map.
- Requires protection for all inbound traffic.

In this scenario, the security appliance silently drops all inbound packets that lack IPsec protection.

Be sure that you define which packets to protect. If you use the **any** keyword in a **permit** statement, preface it with a series of **deny** statements to filter out traffic that would otherwise fall within that **permit** statement that you do not want to protect.

Changing IPsec SA Lifetimes

You can change the global lifetime values that the security appliance uses when negotiating new IPsec SAs. You can override these global lifetime values for a particular crypto map.

IPsec SAs use a derived, shared, secret key. The key is an integral part of the SA; they time out together to require the key to refresh. Each SA has two lifetimes: “timed” and “traffic-volume.” An SA expires after the respective lifetime and negotiations begin for a new one. The default lifetimes are 28,800 seconds (eight hours) and 4,608,000 kilobytes (10 megabytes per second for one hour).

If you change a global lifetime, the security appliance drops the tunnel. It uses the new value in the negotiation of subsequently established SAs.

When a crypto map does not have configured lifetime values and the security appliance requests a new SA, it inserts the global lifetime values used in the existing SA into the request sent to the peer. When a peer receives a negotiation request, it uses the smaller of either the lifetime value the peer proposes or the locally configured lifetime value as the lifetime of the new SA.

The peers negotiate a new SA before crossing the lifetime threshold of the existing SA to ensure that a new SA is ready when the existing one expires. The peers negotiate a new SA when about 5 to 15 percent of the lifetime of the existing SA remains.

Creating a Basic IPsec Configuration

The following steps cover basic IPsec configuration with static crypto maps.

- Step 1** Create an access list to define the traffic to protect:

```
access-list access-list-name {deny | permit} ip source source-netmask destination
destination-netmask
```

For example:

```
access-list 101 permit ip 10.0.0.0 255.255.255.0 10.1.1.0 255.255.255.0
```

In this example, the **permit** keyword causes all traffic that matches the specified conditions to be protected by crypto.

- Step 2** Configure a transform set that defines how to protect the traffic. You can configure multiple transform sets, and then specify one or more of these transform sets in a crypto map (Step 3c).

```
crypto ipsec transform-set transform-set-name transform1 [tctransform2, transform3]
```

For example:

```
crypto ipsec transform-set myset1 esp-des esp-sha-hmac
crypto ipsec transform-set myset2 esp-3des esp-sha-hmac
crypto ipsec transform-set aes_set esp-md5-hmac esp-aes-256
```

In this example, “myset1” and “myset2” and “aes_set” are the names of the transform sets.

- Step 3** Create a crypto map by performing the following steps:

- a. Assign an access list to a crypto map:

```
crypto map map-name seq-num match address access-list-name
```

In the following example, “mymap” is the name of the crypto map set. The map set sequence number 10, which is used to rank multiple entries within one crypto map set. The lower the sequence number, the higher the priority.

```
crypto map mymap 10 match address 101
```

In this example, the access list named 101 is assigned to crypto map “mymap.”

- b. Specify the peer to which the IPsec protected traffic can be forwarded:

```
crypto map map-name seq-num set peer ip-address
```

For example:

```
crypto map mymap 10 set peer 192.168.1.100
```

The security appliance sets up an SA with the peer assigned the IP address 192.168.1.100. Specify multiple peers by repeating this command.

- c. Specify which transform sets are allowed for this crypto map. List multiple transform sets in order of priority (highest priority first). You can specify up to six transform sets.

```
crypto map map-name seq-num set transform-set transform-set-name1
[transform-set-name2, ...transform-set-name6]
```

For example:

```
crypto map mymap 10 set transform-set myset1 myset2
```

In this example, when traffic matches access list 101, the SA can use either “myset1” (first priority) or “myset2” (second priority) depending on which transform set matches the peer’s transform set.

- d. (Optional) Specify an SA lifetime for the crypto map if you want to override the global lifetime.

```
crypto map map-name seq-num set security-association lifetime {seconds seconds |
kilobytes kilobytes}
```

For example:

```
crypto map mymap 10 set security-association lifetime seconds 2700
```

This example shortens the timed lifetime for the crypto map “mymap 10” to 2700 seconds (45 minutes). The traffic volume lifetime is not changed.

- e. (Optional) Specify that IPsec require perfect forward secrecy when requesting new SA for this crypto map, or require PFS in requests received from the peer:

```
crypto map map-name seq-num set pfs [group1 | group2 | group5 | group7]
```

For example:

```
crypto map mymap 10 set pfs group2
```

This example requires PFS when negotiating a new SA for the crypto map “mymap 10.”

The security appliance uses the 1024-bit Diffie-Hellman prime modulus group in the new SA.

- Step 4** Apply a crypto map set to an interface for evaluating IPsec traffic:

```
crypto map map-name interface interface-name
```

For example:

```
crypto map mymap interface outside
```

In this example, the security appliance evaluates the traffic going through the outside interface against the crypto map “mymap” to determine whether it needs to be protected.

Using Dynamic Crypto Maps

Dynamic crypto maps can ease IPsec configuration and we recommend them for use in networks where the peers are not always predetermined. Use dynamic crypto maps for Cisco VPN clients (such as mobile users) and routers that obtain dynamically assigned IP addresses.



Note

Use care when using the **any** keyword in **permit** entries in dynamic crypto maps. If the traffic covered by such a **permit** entry could include multicast or broadcast traffic, insert **deny** entries for the appropriate address range into the access list. Remember to insert **deny** entries for network and subnet broadcast traffic, and for any other traffic that IPsec should not protect.

Dynamic crypto maps work only to negotiate SAs with remote peers that initiate the connection. The security appliance cannot use dynamic crypto maps to initiate connections to a remote peer. With a dynamic crypto map, if outbound traffic matches a permit entry in an access list and the corresponding SA does not yet exist, the security appliance drops the traffic.

A dynamic crypto map is essentially a crypto map without all the parameters configured. It acts as a policy template where the missing parameters are later dynamically configured (as the result of an IPsec negotiation) to match the peer requirements. Dynamic crypto maps let peers exchange IPsec traffic with the security appliance even if the security appliance does not have a crypto map specifically configured that meets all the peer requirements.



Note A dynamic crypto map requires only the **transform-set** parameter.

A crypto map set may include a dynamic crypto map. Dynamic crypto map sets should be the lowest priority crypto maps in the crypto map set (that is, they should have the highest sequence numbers) so that the security appliance evaluates other crypto maps first. It examines the dynamic crypto map set only when the other (static) map entries do not match.

Similar to static crypto map sets, a dynamic crypto map set consists of all of the dynamic crypto maps with the same dynamic-map-name. The dynamic-seq-num differentiates the dynamic crypto maps in a set. If you configure a dynamic crypto map, insert a permit ACL to identify the data flow of the IPsec peer for the crypto access list. Otherwise the security appliance accepts any data flow identity the peer proposes.

The procedure for using a crypto dynamic map entry is the same as the basic configuration described in “[Creating a Basic IPsec Configuration](#),” except that instead of creating a static crypto map, you create a crypto dynamic map entry. You can also combine static and dynamic map entries within a single crypto map set.

Create a crypto dynamic map entry by performing the following steps:

Step 1 (Optional) Assign an access list to a dynamic crypto map:

```
crypto dynamic-map dynamic-map-name dynamic-seq-num match address access-list-name
```

This determines which traffic should be protected and not protected.

For example:

```
crypto dynamic-map dyn1 10 match address 101
```

In this example, access list 101 is assigned to dynamic crypto map “dyn1.” The map’s sequence number is 10.

Step 2 Specify which transform sets are allowed for this dynamic crypto map. List multiple transform sets in order of priority (highest priority first).

```
crypto dynamic-map dynamic-map-name dynamic-seq-num set transform-set transform-set-name1,
[transform-set-name2, ...transform-set-name9]
```

For example:

```
crypto dynamic-map dyn 10 set transform-set myset1 myset2
```

In this example, when traffic matches access list 101, the SA can use either “myset1” (first priority) or “myset2” (second priority), depending on which transform set matches the peer’s transform sets.

Step 3 (Optional) Specify the SA lifetime for the crypto dynamic map entry if you want to override the global lifetime value:

```
crypto dynamic-map dynamic-map-name dynamic-seq-num set security-association lifetime
{seconds seconds | kilobytes kilobytes}
```

For example:

```
crypto dynamic-map dyn1 10 set security-association lifetime seconds 2700
```

This example shortens the timed lifetime for dynamic crypto map “dyn1 10” to 2700 seconds (45 minutes). The time volume lifetime is not changed.

- Step 4** (Optional) Specify that IPsec ask for PFS when requesting new SAs for this dynamic crypto map, or should demand PFS in requests received from the peer:

```
crypto dynamic-map dynamic-map-name dynamic-seq-num set pfs [group1 | group2 | group5 | group7]
```

For example:

```
crypto dynamic-map dyn1 10 set pfs group5
```

- Step 5** Add the dynamic crypto map set into a static crypto map set.

Be sure to set the crypto maps referencing dynamic maps to be the lowest priority entries (highest sequence numbers) in a crypto map set.

```
crypto map map-name seq-num ipsec-isakmp dynamic dynamic-map-name
```

For example:

```
crypto map mymap 200 ipsec-isakmp dynamic dyn1
```

Providing Site-to-Site Redundancy

You can define multiple peers by using crypto maps to provide redundancy. This configuration is useful for site-to-site VPNs.

If one peer fails, the security appliance establishes a tunnel to the next peer associated with the crypto map. It sends data to the peer that it has successfully negotiated with, and that peer becomes the “active” peer. The “active” peer is the peer that the security appliance keeps trying first for follow-on negotiations until a negotiation fails. At that point the security appliance goes on to the next peer. The security appliance cycles back to the first peer when all peers associated with the crypto map have failed.

Viewing an IPsec Configuration

Table 23-5 lists commands you can enter to view information about your IPsec configuration.

Table 23-5 Commands to View IPsec Configuration Information

Command	Purpose
<code>show running-configuration crypto</code>	Displays the entire crypto configuration, including IPsec, crypto maps, dynamic crypto maps, and ISAKMP.
<code>show running-config crypto ipsec</code>	Displays the complete IPsec configuration.
<code>show running-config crypto isakmp</code>	Displays the complete ISAKMP configuration.
<code>show running-config crypto map</code>	Displays the complete crypto map configuration.

Table 23-5 *Commands to View IPsec Configuration Information (continued)*

Command	Purpose
<code>show running-config crypto dynamic-map</code>	Displays the dynamic crypto map configuration.
<code>show all crypto map</code>	View all of the configuration parameters, including those with default values.

Clearing Security Associations

Certain configuration changes take effect only when negotiating subsequent SAs. If you want the new settings to take effect immediately, clear the existing SAs to reestablish them with the changed configuration. If the security appliance is actively processing IPsec traffic, it is desirable to clear only the portion of the SA database that the configuration changes would affect. Reserve clearing the full SA database for large-scale changes, or when the security appliance is processing a small amount of IPsec traffic.

Table 23-6 lists commands you can enter to clear and reinitialize IPsec SAs.

Table 23-6 *Commands to Clear and Reinitialize IPsec SAs*

Command	Purpose
<code>clear configure crypto</code>	Removes an entire crypto configuration, including IPsec, crypto maps, dynamic crypto maps, and ISAKMP.
<code>clear configure crypto ca trustpoint</code>	Removes all trustpoints.
<code>clear configure crypto dynamic-map</code>	Removes all dynamic crypto maps. Includes keywords that let you remove specific dynamic crypto maps.
<code>clear configure crypto map</code>	Removes all crypto maps. Includes keywords that let you remove specific crypto maps.
<code>clear configure isakmp</code>	Removes the entire ISAKMP configuration.
<code>clear configure isakmp policy</code>	Removes all ISAKMP policies or a specific policy.
<code>clear isakmp sa</code>	Removes the entire ISAKMP SA database.

Clearing Crypto Map Configurations

The `clear configure crypto` command includes arguments that let you remove elements of the crypto configuration, including IPsec, crypto maps, dynamic crypto maps, CA trustpoints, all certificates, certificate map configurations, and ISAKMP.

Be aware that if you enter the `clear configure crypto` command without arguments, you remove the entire crypto configuration, including all certificates.

For more information, see the `clear configure crypto` command in the *Cisco Security Appliance Command Reference*.



Setting General VPN Parameters

The security appliance implementation of virtual private networking includes useful features that do not fit neatly into categories. This chapter describes some of these features. It includes the following sections:

- [Configuring VPNs in Single, Routed Mode, page 24-1](#)
- [Configuring IPSec to Bypass ACLs, page 24-1](#)
- [Permitting Intra-Interface Traffic, page 24-2](#)
- [Setting Maximum Active IPSec VPN Sessions, page 24-3](#)
- [Configuring Client Update, page 24-3](#)

Configuring VPNs in Single, Routed Mode

VPNs work only in single, routed mode. VPN functionality is unavailable in configurations that include either security contexts, also referred to as multi-mode firewall, or Active/Active stateful failover.

The exception to this caveat is that you can configure and use one connection for administrative purposes to (not through) the security appliance in transparent mode.

Configuring IPSec to Bypass ACLs

To permit any packets that come from an IPSec tunnel without checking ACLs for the source and destination interfaces, enter the **sysopt connection permit-ipsec** command in global configuration mode.

You might want to bypass interface ACLs for IPSec traffic if you use a separate VPN concentrator behind the security appliance and want to maximize the security appliance performance. Typically, you create an ACL that permits IPSec packets using the **access-list** command and apply it to the source interface. Using an ACL is more secure because you can specify the exact traffic you want to allow through the security appliance.

The syntax is **sysopt connection permit-ipsec**. The command has no keywords or arguments.

The following example enables IPSec traffic through the security appliance without checking ACLs:

```
hostname(config)# sysopt connection permit-ipsec
```

Permitting Intra-Interface Traffic

The security appliance includes a feature that lets a VPN client send IPSec-protected traffic to another VPN user by allowing such traffic in and out of the same interface. Also called “hairpinning”, this feature can be thought of as VPN spokes (clients) connecting through a VPN hub (security appliance).

In another application, this feature can redirect incoming VPN traffic back out through the same interface as unencrypted traffic. This would be useful, for example, to a VPN client that does not have split tunneling but needs to both access a VPN and browse the Web.

Figure 24-1 shows VPN Client 1 sending secure IPSec traffic to VPN Client 2 while also sending unencrypted traffic to a public Web server.

Figure 24-1 VPN Client Using Intra-Interface Feature for Hairpinning

To configure this feature, use the **same-security-traffic** command in global configuration mode with its **intra-interface** argument.

The command syntax is **same-security-traffic permit {inter-interface | intra-interface}**.

The following example shows how to enable intra-interface traffic:

```
hostname(config)# same-security-traffic permit intra-interface
hostname(config)#
```



Note

You use the **same-security-traffic** command, but with the **inter-interface** argument, to permit communication between interfaces that have the same security level. This feature is not specific to IPSec connections. For more information, see the “Configuring Interface Parameters” chapter of this guide.

To use hairpinning, you must apply the proper NAT rules to the security appliance interface, as discussed in the following section.

NAT Considerations for Intra-Interface Traffic

For the security appliance to send unencrypted traffic back out through the interface, you must enable NAT for the interface so that publicly routable addresses replace your private IP addresses (unless you already use public IP addresses in your local IP address pool). The following example applies an interface PAT rule to traffic sourced from the client IP pool:

```
hostname(config)# ip local pool clientpool 192.168.0.10-192.168.0.100
hostname(config)# global (outside) 1 interface
hostname(config)# nat (outside) 1 192.168.0.0 255.255.255.0
```

When the security appliance sends encrypted VPN traffic back out this same interface, however, NAT is optional. The VPN-to-VPN hairpinning works with or without NAT. To apply NAT to all outgoing traffic, implement only the commands above. To exempt the VPN-to-VPN traffic from NAT, add commands (to the example above) that implement NAT exemption for VPN-to-VPN traffic, such as:

```
hostname(config)# access-list nonat permit ip 192.168.0.0 255.255.255.0 192.168.0.0
255.255.255.0
hostname(config)# nat (outside) 0 access-list nonat
```

For more information on NAT rules, see the “Applying NAT” chapter of this guide.

Setting Maximum Active IPSec VPN Sessions

To limit VPN sessions to a lower value than the security appliance allows, enter the **vpn-sessiondb max-session-limit** command in global configuration mode.

- This command applies to all types of VPN sessions, including WebVPN.
- This limit affects the calculated load percentage for VPN Load Balancing.

The syntax is **vpn-sessiondb max-session-limit {session-limit}**.

The following example shows how to set a maximum VPN session limit of 450:

```
hostname (config)# vpn-sessiondb max-session-limit 450
hostname (config)#
```

Configuring Client Update

The client update feature lets administrators at a central location automatically notify VPN client users when it is time to update the VPN client software and the VPN 3002 hardware client image.

To configure client update, enter the **client-update** command in tunnel-group ipsec-attributes configuration mode. If the client is already running a software version on the list of revision numbers, it does not need to update its software. If the client is not running a software version on the list, it should update. You can specify up to 4 client update entries.

The command syntax follows:

client-update type *type* {**url** *url-string*} {**rev-nums** *rev-nums*}

no client-update [*type*]

Syntax Description		
rev-nums <i>rev-nums</i>		Specifies the software or firmware images for this client. Enter up to 4, separated by commas.
<i>type</i>		Specifies the operating systems to notify of a client update. The list of operating systems comprises the following: <ul style="list-style-type: none"> • Windows: all windows-based platforms • WIN9X: Windows 95, Windows 98, and Windows ME platforms • WinNT: Windows NT 4.0, Windows 2000, and Windows XP platforms • vpn3002: VPN 3002 hardware client
url <i>url-string</i>		Specifies the URL for the software/firmware image. This URL must point to a file appropriate for the client.

The following example configures client update parameters for the remote-access tunnel-group called `remotegrp`. It designates the revision number 4.6.1 and the URL for retrieving the update, which is `https://support/updates`.

```
hostname(config)# tunnel-group remotegrp type ipsec_ra
hostname(config)# tunnel-group remotegrp ipsec-attributes
hostname(config-ipsec)# client-update type windows url https://support/updates/ rev-nums
4.6.1
hostname(config-ipsec)#
```



Configuring Tunnel Groups, Group Policies, and Users

This chapter describes how to configure VPN tunnel groups, group policies, and users. This chapter includes the following sections.

- [Overview of Tunnel Groups, Group Policies, and Users, page 25-1](#)
- [Configuring Tunnel Groups, page 25-4](#)
- [Group Policies, page 25-10](#)
- [Configuring Users, page 25-31](#)

In summary, you first configure tunnel groups to set the values for the connection. Then you configure group policies. These set values for users in the aggregate. Then you configure users, which can inherit values from groups and configure certain values on an individual user basis. This chapter describes how and why to configure these entities.

Overview of Tunnel Groups, Group Policies, and Users

Groups and users are core concepts in managing the security of virtual private networks (VPNs) and in configuring the security appliance. They specify attributes that determine user access to and use of the VPN. A *group* is a collection of users treated as a single entity. *Users* get their attributes from *group policies*. *Tunnel groups* identify the group policy for a specific connection. If you do not assign a particular group policy to a user, the default group policy for the connection applies.

Tunnel groups and group policies simplify system management. To streamline the configuration task, the security appliance provides a default LAN-to-LAN tunnel group (DefaultL2Lgroup), a default remote access tunnel group (DefaultRAGroup), and a default group policy (DfltGrpPolicy). The default tunnel groups and group policy provide settings that are likely to be common for many users. As you add users, you can specify that they “inherit” parameters from a group policy. Thus you can quickly configure VPN access for large numbers of users.

If you decide to grant identical rights to all VPN users, then you do not need to configure specific tunnel groups or group policies, but VPNs seldom work that way. For example, you might allow a finance group to access one part of a private network, a customer support group to access another part, and an MIS group to access other parts. In addition, you might allow specific users within MIS to access systems that other MIS users cannot access. Tunnel groups and group policies provide the flexibility to do so securely.

**Note**

The security appliance also includes the concept of object groups, which are a superset of network lists. Object groups let you define VPN access to ports as well as networks. Object groups relate to ACLs rather than to group policies and tunnel groups. For more information about using object groups, see [Chapter 13, “Identifying Traffic with Access Lists.”](#)

Tunnel Groups

A tunnel group consists of a set of records that contain tunnel connection policies. Tunnel groups contain a small number of attributes that pertain to creating the tunnel itself. Tunnel groups include a pointer to a group policy that defines user-oriented attributes.

The security appliance provides two default tunnel groups, one for LAN-to-LAN connections, and one for remote access connections. You can modify these default tunnel groups, but you cannot delete them. You can also create one or more tunnel groups specific to your environment. Tunnel groups are local to the security appliance and are not configurable on external servers.

Tunnel groups specify the following attributes:

- General parameters
- IPsec connection parameters

General Tunnel Group Parameters

The general parameters include the following:

- Tunnel group name—Both remote access and LAN-to-LAN clients select a tunnel group by its name, as follows:
 - For IPsec clients that use preshared keys to authenticate, the tunnel group name is the same as the group name that the IPsec client passes to the security appliance.
 - IPsec clients that use certificates to authenticate pass this name as part of the certificate, and the security appliance extracts the name from the certificate.

Tunnel group records contain tunnel connection policy information. These records identify the servers to which the tunnel user is authenticated, as well as the accounting servers to which connection information is sent. They also identify a default group policy for the connection, and they contain protocol-specific connection parameters.

- Connection type—Connection types include remote access IPsec, and LAN-to-LAN IPsec. A tunnel group can have only one connection type.
- Authentication, Authorization, and Accounting servers—These parameters identify the server groups or lists that the security appliance uses for the following purposes:
 - Authenticating users
 - Obtaining information about services users are authorized to access
 - Storing accounting records

A server group can consist of one or more servers.

- Default group policy for the connection—A group policy is a set of user-oriented attributes. The default group policy is the group policy whose attributes the security appliance uses as defaults when authenticating or authorizing a tunnel user.
- Client address assignment method—This method includes values for one or more DHCP servers or address pools that the security appliance assigns to clients.

IPSec Connection Parameters

IPSec parameters include the following:

- A client authentication method: preshared keys or certificates.
- ISAKMP keepalive settings. This feature lets the security appliance monitor the continued presence of a remote peer and report its own presence to that peer. If the peer becomes unresponsive, the security appliance removes the connection. Enabling IKE keepalives prevents hung connections when the IKE peer loses connectivity.

There are various forms of IKE keepalives. For this feature to work, both the security appliance and its remote peer must support a common form. This feature works with the following peers:

- Cisco VPN client (Release 3.0 and above)
- Cisco VPN 3000 Client (Release 2.x)
- Cisco VPN 3002 Hardware Client
- Cisco VPN 3000 Series Concentrators
- Cisco IOS software
- Cisco Secure PIX Firewall

Non-Cisco VPN clients do not support IKE keepalives.

If you are configuring a group of mixed peers, and some of those peers support IKE keepalives and others do not, enable IKE keepalives for the entire group. The feature does not affect the peers that do not support it.

If you disable IKE keepalives, connections with unresponsive peers remain active until they time out, so we recommend that you keep your idle timeout short. To change your idle timeout, see [“Configuring Group Policies” section on page 25-12](#).



Note

To reduce connectivity costs, disable IKE keepalives if this group includes any clients connecting via ISDN lines. ISDN connections normally disconnect if idle, but the IKE keepalives mechanism prevents connections from idling and therefore from disconnecting.

If you do disable IKE keepalives, the client disconnects only when either its IKE or IPSec keys expire. Failed traffic does not disconnect the tunnel with the Peer Timeout Profile values as it does when IKE keepalives are enabled.



Note

If you have a LAN-to-LAN configuration using IKE main mode, make sure that the two peers have the same IKE keepalives configuration. Both peers must have IKE keepalives enabled or both peers must have it disabled.

- Values for defining authorization usernames.

Configuring Tunnel Groups

The security appliance provides two default tunnel groups, one for remote access (DefaultRAGroup) and one for LAN-to-LAN (DefaultL2LGroup). You can modify these groups, but you cannot delete them. To see the current configured and default configuration of all your tunnel groups, including the default tunnel group, enter the **show running-config all tunnel-group** command.

You can configure a new tunnel group as either an IPsec Remote Access (ipsec-ra) tunnel or an IPsec LAN-to-LAN (ipsec-l2l) tunnel. The default is ipsec-ra. The subsequent parameters depend upon your choice of tunnel type.

Default Remote Access Tunnel Group Configuration

The contents of the default remote-access tunnel group are as follows:

```
tunnel-group DefaultRAGroup type ipsec-ra
tunnel-group DefaultRAGroup general-attributes
  no address-pool
  authentication-server-group LOCAL
  no authorization-server-group
  no accounting-server-group
  default-group-policy DfltGrpPolicy
  no dhcp-server
  no strip-realm
  no strip-group
tunnel-group DefaultRAGroup ipsec-attributes
  no pre-shared-key
  no authorization-required
  authorization-dn-attributes CN OU
  peer-id-validate req
  no radius-with-expiry
  no chain
  no trust-point
  isakmp keepalive threshold 300 retry 2
```

Configuring Remote-Access Tunnel Groups

To configure a remote-access tunnel group, follow the steps in this section. An IPsec Remote Access VPN tunnel group applies only to remote-access IPsec client connections.

Specify a Name and Type for the Remote-Access Tunnel Group

To assign a name and type for the tunnel group, enter the **tunnel-group** command to assign a name and type for the tunnel group.

```
hostname(config)# tunnel-group tunnel_group_name type tunnel_type
```

For a remote-access tunnel, the type is **ipsec-ra**; for example:

```
hostname(config)# tunnel-group TunnelGroup1 type ipsec-ra
```

Configure Remote-Access Tunnel Group General Attributes

To configure the tunnel group general attributes, specify the parameters in the following steps.

- Step 1** Enter the config-general mode by specifying the **tunnel-group** command with the general-attributes designator:

```
hostname(config)# tunnel-group tunnel_group_name general-attributes
```

This command enters config-general mode, in which you configure the tunnel-group general attributes.

- Step 2** Specify the name of the authentication-server group, if any, to use. If you want to use the LOCAL database for authentication if the specified server group fails, append the word LOCAL:

```
hostname(config-general)# authentication-server-group groupname [LOCAL]
```

You can also configure interface-specific authentication by including the name of an interface after the group name. The following command configures interface-specific authentication for the interface named “test” using the server “servergroup1” for authentication:

```
hostname(config-general)# authentication-server-group test servergroup1
```

- Step 3** Specify the name of the authorization-server group, if any, to use:

```
hostname(config-general)# authorization-server-group groupname
```

- Step 4** Specify the name of the accounting-server group, if any, to use:

```
hostname(config-general)# accounting-server-group groupname
```

- Step 5** Specify the name of the default group policy:

```
hostname(config-general)# default-group-policy policyname
```

The following example sets “DfltGrpPolicy” as the name of the group policy:

```
hostname(config)# default-group-policy DfltGrpPolicy
```

- Step 6** Specify the name or IP address of the DHCP server (up to 10 servers), and the names of the DHCP address pools (up to 6 pools). The defaults are no DHCP server and no address pool.

```
hostname(config-general)# dhcp-server server1 [...server10]
hostname(config-general)# address-pool [(interface name)] address_pool1 [...address_pool6]
```



Note The interface name must be enclosed in parentheses.

You configure address pools with the **ip local pool** command in global configuration mode.

- Step 7** Specify whether to strip the group or the realm from the username before passing it on to the AAA server. The default is not to strip either the group name or the realm.

```
hostname(config-general)# strip-group
hostname(config-general)# strip-realm
```

Enter the **strip-realm** command to remove the realm qualifier of the username during authentication. If you do so, authentication is based on the *username* alone. Otherwise, authentication is based on the full *username@realm* string. You must enable strip realm if your server is unable to parse delimiters. If you are using the Group Lookup feature and strip realm, do not use the @ character for the group delimiter.

- Step 8** Whether users must exist in the authorization database to connect.

```
hostname(config)# authorization-server-group groupname
```

Configure Remote-Access Tunnel Group IPsec Attributes

To configure the IPsec attributes, specify the following parameters:

- Step 1** Specify the IPsec-attributes designator:

```
hostname(config)# tunnel-group tunnel-group-name ipsec-attributes
```

For example, the following command designates that the config-ipsec mode commands that follow pertain to the tunnel group named “TG1”:

```
hostname(config)# tunnel-group TG1 ipsec-attributes
```

This command enters config-ipsec mode, in which you configure the tunnel-group IPsec attributes.

- Step 2** Specify the attribute or attributes to use in deriving a name for an authorization query from a certificate. This attribute specifies what part of the subject DN field to use as the username for authorization:

```
hostname(config-ipsec)# authorization-dn-attributes {primary-attribute  
[secondary-attribute] | use-entire-name}
```

For example, the following command specifies the use of the “CN” attribute as the username for authorization:

```
hostname(config-ipsec)# authorization-dn-attributes CN
```

The authorization-dn-attributes are **C** (Country), **CN** (Common Name), **DNQ** (DN qualifier), **EA** (E-mail Address), **GENQ** (Generational qualifier), **GN** (Given Name), **I** (Initials), **L** (Locality), **N** (Name), **O** (Organization), **OU** (Organizational Unit), **SER** (Serial Number), **SN** (Surname), **SP** (State/Province), **T** (Title), and **UID** (User ID)

- Step 3** Specify whether to require a successful authorization before allowing a user to connect. The default is not to require authorization.

```
hostname(config-ipsec)# authorization-required
```

- Step 4** Specify the client-update parameters; that is, the client type and the acceptable revision levels for that client:

```
hostname(config-ipsec)# client-update type type url url-string rev-nums rev-numbers
```

The available client types are **Win9X** (includes Windows 95, Windows 98 and Windows ME platforms), **WinNT** (includes Windows NT 4.0, Windows 2000 and Windows XP platforms), **Windows** (Includes all Windows based platforms), and **vpn3002** (VPN3002 hardware client).

If the client is already running a software version on the list of revision numbers, it does not need to update its software. If the client is not running a software version on the list, it should update. You can specify up to four of these client update entries.

The following example configures client update parameters for the remote-access tunnel-group. It designates the revision number, 4.6.1 and the URL for retrieving the update, which is “https://support/updates”:

```
hostname(config-ipsec)# client-update type windows url https://support/updates/ rev-nums  
4.6.1
```

- Step 5** Specify the preshared key to support IKE connections based on preshared keys.

```
hostname(config-ipsec)# pre-shared-key xyzx
```

The preceding command specifies the preshared key *xyzx* to support IKE connections for an IPSec remote access tunnel group:

- Step 6** Specify whether to validate the identity of the peer using the peer's certificate:

```
hostname(config-ipsec)# peer-id-validate option
```

The available options are **req** (required), **cert** (if supported by certificate), and **nocheck** (do not check). The default is **req**.

- Step 7** Specify whether to enable sending of a certificate chain. The following command includes the root certificate and any subordinate CA certificates in the transmission:

```
hostname(config-ipsec)# chain
```

You can apply this attribute to all tunnel-group types.

- Step 8** Specify the name of a trustpoint that identifies the certificate to be sent to the IKE peer:

```
hostname(config-ipsec)# trust-point trust-point-name
```

The following command specifies "mytrustpoint" as the name of the certificate to be sent to the IKE peer:

```
hostname(config-ipsec)# trust-point mytrustpoint
```

You can apply this attribute to all tunnel-group types.

- Step 9** Specify whether to have the security appliance use MS-CHAPv2 to negotiate a password update with the user during authentication:

```
hostname(config-ipsec)# radius-with-expiry
```

The security appliance ignores this command if RADIUS authentication has not been configured.

- Step 10** ISAKMP keepalive threshold and the number of retries allowed.

```
hostname(config)# isakmp keepalive threshold <number> retry <number>
```

The **threshold** parameter specifies the number of seconds (10 through 3600) that the peer is allowed to idle before beginning keepalive monitoring. The **retry** parameter is the interval (2 through 10 seconds) between retries after a keepalive response has not been received. IKE keepalives are enabled by default. To disable IKE keepalives, enter the **no** form of the **isakmp** command:

For example, the following command sets the IKE keepalive threshold value to 15 seconds and sets the retry interval to 10 seconds:

```
hostname(config-ipsec)# isakmp keepalive threshold 15 retry 10
```

The default value for the **threshold** parameter is 300 for remote-access and 10 for LAN-to-LAN, and the default value for the **retry** parameter is 2.

Default LAN-to-LAN Tunnel Group Configuration

The contents of the default LAN-to-LAN tunnel group are as follows:

```
tunnel-group DefaultL2LGroup type ipsec-l2l
tunnel-group DefaultL2LGroup general-attributes
  no accounting-server-group
  default-group-policy DfltGrpPolicy
tunnel-group DefaultL2LGroup ipsec-attributes
  no pre-shared-key
  peer-id-validate req
  no chain
  no trust-point
  isakmp keepalive threshold 10 retry 2
```

LAN-to-LAN tunnel groups have fewer parameters than remote-access tunnel groups, and most of these are the same for both groups. For your convenience in configuring the connection, they are listed separately here.

Configuring LAN-to-LAN Tunnel Groups

An IPsec LAN-to-LAN VPN tunnel group applies only to LAN-to-LAN IPsec client connections. To configure a LAN-to-LAN tunnel group, follow the steps in this section.

Specify a Name and Type for the LAN-to-LAN Tunnel Group

To specify a name and a type for a tunnel group, enter the **tunnel-group** command, as follows:

```
hostname(config)# tunnel-group tunnel_group_name type tunnel_type
```

For a LAN-to-LAN tunnel, the type is **ipsec-l2l**.; for example:

```
hostname(config)# tunnel-group TunnelGroup1 type ipsec-l2l
```

Configure LAN-to-LAN Tunnel Group General Attributes

To configure the tunnel group general attributes, specify the parameters in the following steps:

-
- Step 1** Enter configuration-general mode by specifying the general-attributes designator:

```
hostname(config)# tunnel-group tunnel_group_tunnel-group-name general-attributes
hostname(config-general)#
```

The prompt changes to indicate that you are now in config-general mode, in which you configure the tunnel-group general attributes.

- Step 2** Specify the name of the accounting-server group, if any, to use:

```
hostname(config-general)# accounting-server-group groupname
```

For example, the following command specifies the use of the accounting-server group “acctgserv1”:

```
hostname(config-general)# accounting-server-group acctgserv1
```

Step 3 Specify the name of the default group policy:

```
hostname(config-general)# default-group-policy policyname
```

For example, the following command specifies that the name of the default group policy is “MyPolicy”:

```
hostname(config-general)# default-group-policy MyPolicy
```

Configure LAN-to-LAN IPSec Attributes

To configure the IPSec attributes, do the following steps:

Step 1 To enter config-ipsec mode, in which you configure the tunnel-group IPSec attributes, enter the tunnel-group command with the IPSec-attributes designator.

```
hostname(config)# tunnel-group tunnel-group-name ipsec-attributes
```

For example, the following command enters config-ipsec mode so you can configure the parameters for the tunnel group named “TG1”:

```
hostname(config)# tunnel-group TG1 ipsec-attributes
hostname(config-ipsec)#
```

The prompt changes to indicate that you are now in config-ipsec mode.

Step 2 Specify the preshared key to support IKE connections based on preshared keys.

```
hostname(config-ipsec)# pre-shared-key key
```

For example, the following command specifies the preshared key XYZX to support IKE connections for an IPSec remote access tunnel group:

```
hostname(config-ipsec)# pre-shared-key xyzx
```

Step 3 Specify whether to validate the identity of the peer using the peer’s certificate:

```
hostname(config-ipsec)# peer-id-validate option
```

The available options are **req** (required), **cert** (if supported by certificate), and **nocheck** (do not check). The default is **req**. For example, the following command sets the peer-id-validate option to **nocheck**:

```
hostname(config-ipsec)# peer-id-validate nocheck
```

Step 4 Specify whether to enable sending of a certificate chain. This action includes the root certificate and any subordinate CA certificates in the transmission:

```
hostname(config-ipsec)# chain
```

You can apply this attribute to all tunnel-group types.

Step 5 Specify the name of a trustpoint that identifies the certificate to be sent to the IKE peer:

```
hostname(config-ipsec)# trust-point trust-point-name
```

For example, the following command sets the trustpoint name to “mytrustpoint”:

```
hostname(config-ipsec)# trust-point mytrustpoint
```

You can apply this attribute to all tunnel-group types.

- Step 6** Specify the ISAKMP keepalive threshold and the number of retries allowed. The **threshold** parameter specifies the number of seconds (10 through 3600) that the peer is allowed to idle before beginning keepalive monitoring. The **retry** parameter is the interval (2 through 10 seconds) between retries after a keepalive response has not been received. IKE keepalives are enabled by default. To disable IKE keepalives, enter the **no** form of the **isakmp** command:

```
hostname(config)# isakmp keepalive threshold <number> retry <number>
```

For example, the following command sets the ISAKMP keepalive threshold to 15 seconds and sets the retry interval to 10 seconds.:

```
hostname(config-ipsec)# isakmp keepalive threshold 15 retry 10
```

The default value for the **threshold** parameter for LAN-to-LAN is 10, and the default value for the retry parameter is 2.

Group Policies

A group policy is a set of user-oriented attribute/value pairs for IPsec connections that are stored either internally (locally) on the device or externally on a RADIUS server. The tunnel group refers to a group policy that sets terms for user connections after the tunnel is established. Group policies let you apply whole sets of attributes to a user or a group of users, rather than having to specify each attribute individually for each user.

Enter the **group-policy** commands in global configuration mode to assign a group policy to users or to modify a group policy for specific users.

The security appliance includes a default group policy. You can modify this default group policy, but you cannot delete it. You can also create one or more group policies specific to your environment.

Group policies include the following attributes:

- Identity
- Defining servers
- Client firewall settings
- Tunneling protocols
- IPsec settings
- Hardware client settings
- Filters
- Client configuration settings
- WebVPN functions
- Connection settings

Default Group Policy

The security appliance supplies a default group policy. You can modify this default group policy, but you cannot delete it. A default group policy, named “DfltGrpPolicy”, always exists on the security appliance, but this default group policy does not take effect unless you configure the security appliance to use it. To view the default group policy, enter the following command:

```
hostname(config)# show running-config all group-policy DfltGrpPolicy
```

To configure the default group policy, enter the following command:

```
hostname(config)# group-policy DfltGrpPolicy internal
```



Note

The default group policy is internal. Despite the fact that the command syntax is `hostname(config)# group-policy DfltGrpPolicy {internal | external}`, you cannot change the type to external.

If you want to change any of the attributes of the group policy, use the `group-policy attributes` command to enter attributes mode, then specify the commands to change whatever attributes that you want to modify:

```
hostname(config)# group-policy DfltGrpPolicy attributes
```



Note

The attributes mode applies only for internal group policies.

The default group policy that the security appliance provides, “DfltGrpPolicy”, is as follows:

```
group-policy DfltGrpPolicy internal
group-policy DfltGrpPolicy attributes
wins-server none
dns-server none
vpn-access-hours none
vpn-simultaneous-logins 3
vpn-idle-timeout 30
vpn-session-timeout none
vpn-filter none
vpn-tunnel-protocol IPSec
password-storage disable
ip-comp disable
re-xauth disable
group-lock none
pfs disable
banner none
ipsec-udp disable
ipsec-udp-port 10000
split-tunnel-policy tunnelall
split-tunnel-network-list none
default-domain none
split-dns none
secure-unit-authentication disable
user-authentication disable
user-authentication-idle-timeout 30
ip-phone-bypass disable
leap-bypass disable
nem disable
backup-servers keep-client-config
client-firewall none
client-access-rule none
```

```
webvpn
  functions url-entry
  no html-content-filter
  no homepage
  no filter
  no url-list
  no port-forward
  port-forward-name value Application Access
```

You can modify the default group policy, and you can also create one or more group policies specific to your environment.

Configuring Group Policies

A group policy can apply to either remote-access or LAN-to-LAN IPsec tunnels. In each case, if you do not explicitly define a parameter, the group takes the value from the default group policy. To configure a group policy, follow these steps:

Step 1 Specify a name and type (internal or external) for the group policy:

```
hostname(config)# group-policy group_policy_name type
```

For example, the following command specifies that the group policy is named “GroupPolicy1” and that its type is internal:

```
hostname(config)# group-policy GroupPolicy1 internal
```

The default type is **internal**.

You can initialize the attributes of an internal group policy to the values of a preexisting group policy by appending the keyword **from** and specifying the name of the existing policy:

```
hostname(config)# group-policy group_policy_name internal from group_policy_name
```

For an external group policy, you must identify the AAA server group that the security appliance can query for attributes and specify the password to use when retrieving attributes from the external AAA server group, as follows:

```
hostname(config)# group-policy name external server-group server_group password
server_password}
```



Note For an external group policy, RADIUS is the only supported AAA server type.

Step 2 Enter the group-policy attributes mode, using the **group-policy attributes** command in global configuration mode.

```
hostname(config)# group-policy name attributes
hostname(config-group-policy)#
```

The prompt changes to indicate the mode change. The group-policy-attributes mode lets you configure attribute-value pairs for a specified group policy. In group-policy-attributes mode, explicitly configure the attribute-value pairs that you do not want to inherit from the default group. The commands to do this are described in the following steps.

Step 3 Specify the primary and secondary WINS servers:

```
hostname(config-group-policy)# wins-server value {ip_address [ip_address] | none}
```

The first IP address specified is that of the primary WINS server. The second (optional) IP address is that of the secondary WINS server. Specifying the **none** keyword instead of an IP address sets WINS servers to a null value, which allows no WINS servers and prevents inheriting a value from a default or specified group policy.

Every time that you enter the **wins-server** command, you overwrite the existing setting. For example, if you configure WINS server x.x.x.x and then configure WINS server y.y.y.y, the second command overwrites the first, and y.y.y.y becomes the sole WINS server. The same is true for multiple servers. To add a WINS server rather than overwrite previously configured servers, include the IP addresses of all WINS servers when you enter this command.

The following example shows how to configure WINS servers with the IP addresses 10.10.10.15 and 10.10.10.30 for the group policy named “FirstGroup”:

```
hostname(config)# group-policy FirstGroup attributes
hostname(config-group-policy)# wins-server value 10.10.10.15 10.10.10.30
```

Step 4 Specify the primary and secondary DNS servers:

```
hostname(config-group-policy)# dns-server value {ip_address [ip_address] | none}
```

The first IP address specified is that of the primary DNS server. The second (optional) IP address is that of the secondary DNS server. Specifying the **none** keyword instead of an IP address sets DNS servers to a null value, which allows no DNS servers and prevents inheriting a value from a default or specified group policy.

Every time that you enter the **dns-server** command you overwrite the existing setting. For example, if you configure DNS server x.x.x.x and then configure DNS server y.y.y.y, the second command overwrites the first, and y.y.y.y becomes the sole DNS server. The same is true for multiple servers. To add a DNS server rather than overwrite previously configured servers, include the IP addresses of all DNS servers when you enter this command.

The following example shows how to configure DNS servers with the IP addresses 10.10.10.15, and 10.10.10.30 for the group policy named “FirstGroup”:

```
hostname(config)# group-policy FirstGroup attributes
hostname(config-group-policy)# dns-server value 10.10.10.15 10.10.10.30
```

Step 5 Set the VPN access hours. To do this, you associate a group policy with a configured time-range policy, using the **vpn-access-hours** command in group-policy configuration mode.

```
hostname(config-group-policy)# vpn-access-hours value {time-range | none}
```

A group policy can inherit a time-range value from a default or specified group policy. To prevent this inheritance, enter the **none** keyword instead of the name of a time-range in this command. This keyword sets VPN access hours to a null value, which allows no time-range policy.

The time-range variable is the name of a set of access hours defined in global configuration mode using the **time-range** command. The following example shows how to associate the group policy named “FirstGroup” with a time-range policy called “824”:

```
hostname(config)# group-policy FirstGroup attributes
hostname(config-group-policy)# vpn-access-hours value 824
```

Step 6 Specify the number of simultaneous logins allowed for any user, using the **vpn-simultaneous-logins** command in group-policy configuration mode.

```
hostname(config-group-policy)# vpn-simultaneous-logins integer
```

The default value is 3. The range is an integer in the range 0 through 2147483647. A group policy can inherit this value from another group policy. Enter 0 to disable login and prevent user access. The following example shows how to allow a maximum of 4 simultaneous logins for the group policy named “FirstGroup”:

```
hostname(config)# group-policy FirstGroup attributes
hostname(config-group-policy)# vpn-simultaneous-logins 4
```



Note While there is no maximum limit to the number of simultaneous logins, allowing several could compromise security and affect performance.

- Step 7** Configure the user timeout period by entering the **vpn-idle-timeout** command in group-policy configuration mode or in username configuration mode:

```
hostname(config-group-policy)# vpn-idle-timeout {minutes | none}
```

The minimum time is 1 minute, and the maximum time is 35791394 minutes. The default is 30 minutes. If there is no communication activity on the connection in this period, the security appliance terminates the connection.

A group policy can inherit this value from another group policy. To prevent inheriting a value, enter the **none** keyword instead of specifying a number of minutes with this command. The none keyword also permits an unlimited idle timeout period. It sets the idle timeout to a null value, thereby disallowing an idle timeout.

The following example shows how to set a VPN idle timeout of 15 minutes for the group policy named “FirstGroup”:

```
hostname(config)# group-policy FirstGroup attributes
hostname(config-group-policy)# vpn-idle-timeout 15
```

- Step 8** Configure a maximum amount of time for VPN connections, using the **vpn-session-timeout** command in group-policy configuration mode or in username configuration mode.

```
hostname(config-group-policy)# vpn-session-timeout {minutes | none}
```

The minimum time is 1 minute, and the maximum time is 35791394 minutes. There is no default value. At the end of this period of time, the security appliance terminates the connection.

A group policy can inherit this value from another group policy. To prevent inheriting a value, enter the **none** keyword instead of specifying a number of minutes with this command. Specifying the **none** keyword permits an unlimited session timeout period and sets session timeout with a null value, which disallows a session timeout.

The following example shows how to set a VPN session timeout of 180 minutes for the group policy named “FirstGroup”:

```
hostname(config)# group-policy FirstGroup attributes
hostname(config-group-policy)# vpn-session-timeout 180
```

- Step 9** Specify the name of the ACL to use for VPN connections, using the **vpn-filter** command in group policy or username mode.

```
hostname(config-group-policy)# vpn-filter {value ACL name | none}
```

To remove the ACL, including a null value created by entering the **vpn-filter none** command, enter the **no** form of this command. The **no** option allows inheritance of a value from another group policy.

A group policy can inherit this value from another group policy. To prevent inheriting a value, enter the **none** keyword instead of specifying an ACL name. The **none** keyword indicates that there is no access list and sets a null value, thereby disallowing an access list.

You configure ACLs to permit or deny various types of traffic for this group policy. You then enter the **vpn-filter** command to apply those ACLs.

The following example shows how to set a filter that invokes an access list named “acl_vpn” for the group policy named “FirstGroup”:

```
hostname(config)# group-policy FirstGroup attributes
hostname(config-group-policy)# vpn-filter acl_vpn
```

Step 10 Specify the VPN tunnel type (IPSec or WebVPN) for this group policy.

```
hostname(config-group-policy)# vpn-tunnel-protocol {webvpn | IPSec}
```

The default is IPSec. To remove the attribute from the running configuration, enter the **no** form of this command.

```
hostname(config-group-policy)# no vpn-tunnel-protocol [webvpn | IPSec]
```

The parameter values for this command follow:

IPSec—Negotiates an IPSec tunnel between two peers (a remote access client or another secure gateway). Creates security associations that govern authentication, encryption, encapsulation, and key management.

webvpn—Provides VPN services to remote users via an HTTPS-enabled web browser, and does not require a client.

Enter this command to configure one or more tunneling modes. You must configure at least one tunneling mode for users to connect over a VPN tunnel.

The following example shows how to configure the IPSec tunneling mode for the group policy named “FirstGroup”:

```
hostname(config)# group-policy FirstGroup attributes
hostname(config-group-policy)# vpn-tunnel-protocol IPSec
```

Step 11 Specify whether to let users store their login passwords on the client system, using the **password-storage** command with the **enable** keyword in group-policy configuration mode. To disable password storage, use the **password-storage** command with the **disable** keyword.

```
hostname(config-group-policy)# password-storage {enable | disable}
```

For security reasons, password storage is disabled by default. Enable password storage only on systems that you know to be in secure sites.

To remove the password-storage attribute from the running configuration, enter the **no** form of this command:

```
hostname(config-group-policy)# no password-storage
```

Specifying the **no** form enables inheritance of a value for password-storage from another group policy.

This command does not apply to interactive hardware client authentication or individual user authentication for hardware clients.

The following example shows how to enable password storage for the group policy named “FirstGroup”:

```
hostname(config)# group-policy FirstGroup attributes
hostname(config-group-policy)# password-storage enable
```

Step 12 Specify whether to enable IP compression, which is disabled by default.

```
hostname(config-group-policy)# ip-comp {enable | disable}
```

To enable LZS IP compression, enter the **ip-comp** command with the **enable** keyword in group-policy configuration mode. To disable IP compression, enter the **ip-comp** command with the **disable** keyword.

To remove the **ip-comp** attribute from the running configuration, enter the **no** form of this command. This enables inheritance of a value from another group policy.

```
hostname(config-group-policy)# no ip-comp
```

Enabling data compression might speed up data transmission rates for remote dial-in users connecting with modems.



Caution

Data compression increases the memory requirement and CPU usage for each user session and consequently decreases the overall throughput of the security appliance. For this reason, we recommend that you enable data compression only for remote users connecting with a modem. Design a group policy specific to modem users, and enable compression only for them.

Step 13 Specify whether to require that users reauthenticate on IKE rekey by using the **re-xauth** command with the **enable** keyword in group-policy configuration mode. To disable user reauthentication on IKE rekey, enter the **disable** keyword.

```
hostname(config-group-policy)# re-xauth {enable | disable}
```

To remove the re-xauth attribute from the running configuration, enter the **no** form of this command. This enables inheritance of a value for reauthentication on IKE rekey from another group policy.

```
hostname(config-group-policy)# no re-xauth
```

Reauthentication on IKE rekey is disabled by default. If you enable reauthentication on IKE rekey, the security appliance prompts the user to enter a username and password during initial Phase 1 IKE negotiation and also prompts for user authentication whenever an IKE rekey occurs. Reauthentication provides additional security.

If the configured rekey interval is very short, users might find the repeated authorization requests inconvenient. To avoid repeated authorization requests, disable reauthentication. To check the configured rekey interval, in monitoring mode, enter the **show crypto ipsec sa** command to view the security association lifetime in seconds and lifetime in kilobytes of data.



Note Reauthentication fails if there is no user at the other end of the connection.

Step 14 Specify whether to restrict remote users to access through the tunnel group only, using the **group-lock** command in group-policy configuration mode.

```
hostname(config-group-policy)# group-lock {value tunnel-grp-name | none}
hostname(config-group-policy)# no group-lock
```

The *tunnel-grp-name* variable specifies the name of an existing tunnel group that the security appliance requires for the user to connect. Group-lock restricts users by checking if the group configured in the VPN client is the same as the tunnel group to which the user is assigned. If it is not, the security appliance prevents the user from connecting. If you do not configure group-lock, the security appliance authenticates users without regard to the assigned group. Group locking is disabled by default.

To remove the **group-lock** attribute from the running configuration, enter the **no** form of this command. This option allows inheritance of a value from another group policy.

To disable group-lock, enter the **group-lock** command with the **none** keyword. The none keyword sets group-lock to a null value, thereby allowing no group-lock restriction. It also prevents inheriting a group-lock value from a default or specified group policy

- Step 15** Specify whether to enable perfect forward secrecy by using the **pfs** command with the **enable** keyword in group-policy configuration mode.

```
hostname(config-group-policy)# pfs {enable | disable}
```

In IPsec negotiations, PFS ensures that each new cryptographic key is unrelated to any previous key. PFS is disabled by default.

To disable PFS, enter the **disable** keyword.

To remove the PFS attribute from the running configuration, enter the **no** form of this command. A group policy can inherit a value for PFS from another group policy. To prevent inheriting a value, enter the **no** form of this command.

```
hostname(config-group-policy)# no pfs
```

- Step 16** Specify the banner, or welcome message, if any, that you want to display. The default is no banner. The message that you specify is displayed on remote clients when they connect. To specify a banner, enter the **banner** command in group-policy configuration mode. The banner text can be up to 510 characters long. Enter the “\n” sequence to insert a carriage return.



Note A carriage-return/line-feed included in the banner counts as two characters.

To delete a banner, enter the **no** form of this command. Be aware that using the **no** version of the command deletes all banners for the group policy.

A group policy can inherit this value from another group policy. To prevent inheriting a value, enter the **none** keyword instead of specifying a value for the banner string, as follows:

```
hostname(config-group-policy)# banner {value banner_string | none}
```

The following example shows how to create a banner for the group policy named “FirstGroup”:

```
hostname(config)# group-policy FirstGroup attributes
hostname(config-group-policy)# banner value Welcome to Cisco Systems 7.0.
```

- Step 17** Specify whether to enable IPsec over UDP. To use IPsec over UDP, you must also configure the **ipsec-udp-port** command, as follows:

```
hostname(config-group-policy)# ipsec-udp {enable | disable}
hostname(config-group-policy)# no ipsec-udp
```

IPsec over UDP, sometimes called IPsec through NAT, lets a Cisco VPN client or hardware client connect via UDP to a security appliance that is running NAT. It is disabled by default. To enable IPsec over UDP, configure the **ipsec-udp** command with the **enable** keyword in group-policy configuration mode. To disable IPsec over UDP, enter the **disable** keyword. To remove the IPsec over UDP attribute from the running configuration, enter the **no** form of this command. This enables inheritance of a value for IPsec over UDP from another group policy.

The Cisco VPN client must also be configured to use IPsec over UDP (it is configured to use it by default). The VPN 3002 requires no configuration to use IPsec over UDP.

IPsec over UDP is proprietary; it applies only to remote-access connections, and it requires mode configuration. The security appliance exchanges configuration parameters with the client while negotiating SAs. Using IPsec over UDP may slightly degrade system performance.

The following example shows how to set IPsec over UDP for the group policy named “FirstGroup”:

```
hostname(config)# group-policy FirstGroup attributes
hostname(config-group-policy)# ipsec-udp enable
```

If you enabled IPsec over UDP, you must also configure the **ipsec-udp-port** command in group-policy configuration mode. This command sets a UDP port number for IPsec over UDP. In IPsec negotiations, the security appliance listens on the configured port and forwards UDP traffic for that port even if other filter rules drop UDP traffic. The port numbers can range from 4001 through 49151. The default port value is 10000.

To disable the UDP port, enter the **no** form of this command. This enables inheritance of a value for the IPsec over UDP port from another group policy.

```
hostname(config-group-policy)# ipsec-udp-port port
```

The following example shows how to set an IPsec UDP port to port 4025 for the group policy named “FirstGroup”:

```
hostname(config)# group-policy FirstGroup attributes
hostname(config-group-policy)# ipsec-udp-port 4025
```

Step 18 Set the rules for tunneling traffic by specifying the split-tunneling policy.

```
hostname(config-group-policy)# split-tunnel-policy {tunnelall | tunnelspecified |
excludespecified}
hostname(config-group-policy)# no split-tunnel-policy
```

The default is to tunnel all traffic. To set a split tunneling policy, enter the **split-tunnel-policy** command in group-policy configuration mode. To remove the **split-tunnel-policy** attribute from the running configuration, enter the **no** form of this command. This enables inheritance of a value for split tunneling from another group policy.

Split tunneling lets a remote-access IPsec client conditionally direct packets over an IPsec tunnel in encrypted form or to a network interface in clear text form. With split tunneling enabled, packets not bound for destinations on the other side of the IPsec tunnel do not have to be encrypted, sent across the tunnel, decrypted, and then routed to a final destination. This command applies this split tunneling policy to a specific network.

The **excludespecified** keyword defines a list of networks to which traffic goes in the clear. This feature is useful for remote users who want to access devices on their local network, such as printers, while they are connected to the corporate network through a tunnel. This option applies only to the Cisco VPN client.

The **tunnelall** keyword specifies that no traffic goes in the clear or to any other destination than the security appliance. This, in effect, disables split tunneling. Remote users reach internet networks through the corporate network and do not have access to local networks. This is the default option.

The **tunnelspecified** keyword tunnels all traffic from or to the specified networks. This option enables split tunneling. It lets you create a network list of addresses to tunnel. Data to all other addresses travels in the clear and is routed by the remote user’s Internet service provider.



Note Split tunneling is primarily a traffic management feature, not a security feature. For optimum security, we recommend that you do not enable split tunneling.

The following example shows how to set a split tunneling policy of tunneling only specified networks for the group policy named “FirstGroup”:

```
hostname(config)# group-policy FirstGroup attributes
hostname(config-group-policy)# split-tunnel-policy tunnelspecified
```

- Step 19** Create a network list for split tunneling using the **split-tunnel-network-list** command in group-policy configuration mode.

```
hostname(config-group-policy)# split-tunnel-network-list {value access-list_name | none}
hostname(config-group-policy)# no split-tunnel-network-list value [access-list_name]
```

Split tunneling network lists distinguish networks that require traffic to travel across the tunnel from those that do not require tunneling. The security appliance makes split tunneling decisions on the basis of a network list, which is an ACL that consists of a list of addresses on the private network. Only standard-type ACLs are allowed.

The **value** *access-list name* parameter identifies an access list that enumerates the networks to tunnel or not tunnel.

The **none** keyword indicates that there is no network list for split tunneling; the security appliance tunnels all traffic. Specifying the **none** keyword sets a split tunneling network list with a null value, thereby disallowing split tunneling. It also prevents inheriting a default split tunneling network list from a default or specified group policy.

To delete a network list, enter the **no** form of this command. To delete all split tunneling network lists, enter the **no split-tunnel-network-list** command without arguments. This command deletes all configured network lists, including a null list if you created one by entering the **none** keyword.

When there are no split tunneling network lists, users inherit any network lists that exist in the default or specified group policy. To prevent users from inheriting such network lists, enter the **split-tunnel-network-list none** command.

The following example shows how to set a network list called “FirstList” for the group policy named “FirstGroup”:

```
hostname(config)# group-policy FirstGroup attributes
hostname(config-group-policy)# split-tunnel-network-list FirstList
```

- Step 20** Specify the default domain name. To set a default domain name for users of the group policy, enter the **default-domain** command in group-policy configuration mode. To delete a domain name, enter the **no** form of this command.

```
hostname(config-group-policy)# default-domain {value domain-name | none}
hostname(config-group-policy)# no default-domain [domain-name]
```

The security appliance passes the default domain name to the IPsec client to append to DNS queries that omit the domain field. This domain name applies only to tunneled packets. When there are no default domain names, users inherit the default domain name in the default group policy.

The **value** *domain-name* parameter identifies the default domain name for the group. To specify that there is no default domain name, enter the **none** keyword. This command sets a default domain name with a null value, which disallows a default domain name and prevents inheriting a default domain name from a default or specified group policy.

To delete all default domain names, enter the **no default-domain** command without arguments. This command deletes all configured default domain names, including a null list if you created one by entering the **default-domain** command with the **none** keyword. The **no** form allows inheriting a domain name.

The following example shows how to set a default domain name of “FirstDomain” for the group policy named “FirstGroup”:

```
hostname(config)# group-policy FirstGroup attributes
hostname(config-group-policy)# default-domain value FirstDomain
```

- Step 21** Enter a list of domains to be resolved through the split tunnel. Enter the **split-dns** command in group-policy configuration mode. To delete a list, enter the **no** form of this command.

**Note**

The AnyConnect VPN client and the SSL VPN Client do not support split DNS.

When there are no split tunneling domain lists, users inherit any that exist in the default group policy. To prevent users from inheriting such split tunneling domain lists, enter the **split-dns** command with the **none** keyword.

To delete all split tunneling domain lists, enter the **no split-dns** command without arguments. This deletes all configured split tunneling domain lists, including a null list created by issuing the **split-dns** command with the **none** keyword.

The parameter **value** *domain-name* provides a domain name that the security appliance resolves through the split tunnel. The **none** keyword indicates that there is no split DNS list. It also sets a split DNS list with a null value, thereby disallowing a split DNS list, and prevents inheriting a split DNS list from a default or specified group policy.

```
hostname(config-group-policy)# split-dns {value domain-name1 [domain-name2...
domain-nameN] | none}
hostname(config-group-policy)# no split-dns [domain-name domain-name2 domain-nameN]
```

Enter a single space to separate each entry in the list of domains. There is no limit on the number of entries, but the entire string can be no longer than 255 characters. You can use only alphanumeric characters, hyphens (-), and periods (.).

The following example shows how to configure the domains Domain1, Domain2, Domain3, and Domain4 to be resolved through split tunneling for the group policy named “FirstGroup”:

```
hostname(config)# group-policy FirstGroup attributes
hostname(config-group-policy)# split-dns value Domain1 Domain2 Domain3 Domain4
```

- Step 22** Specify whether to enable secure unit authentication by entering the **secure-unit-authentication** command with the **enable** keyword in group-policy configuration mode.

```
hostname(config-group-policy)# secure-unit-authentication {enable | disable}
hostname(config-group-policy)# no secure-unit-authentication
```

Secure unit authentication provides additional security by requiring VPN hardware clients to authenticate with a username and password each time that the client initiates a tunnel. With this feature enabled, the hardware client does not have a saved username and password. Secure unit authentication is disabled by default.

To disable secure unit authentication, enter the **disable** keyword. To remove the secure unit authentication attribute from the running configuration, enter the **no** form of this command. This option allows inheritance of a value for secure unit authentication from another group policy.

**Note**

With this feature enabled, to bring up a VPN tunnel, a user must be present to enter the username and password.

Secure unit authentication requires that you have an authentication server group configured for the tunnel group the hardware client(s) use.

If you require secure unit authentication on the primary security appliance, be sure to configure it on any backup servers as well.

The following example shows how to enable secure unit authentication for the group policy named “FirstGroup”:

```
hostname(config)# group-policy FirstGroup attributes
hostname(config-group-policy)# secure-unit-authentication enable
```

- Step 23** Specify whether to enable user authentication by entering the **user-authentication** command with the **enable** keyword in group-policy configuration mode.

```
hostname(config-group-policy)# user-authentication {enable | disable}
hostname(config-group-policy)# no user-authentication
```

To disable user authentication, enter the **disable** keyword. To remove the user authentication attribute from the running configuration, enter the **no** form of this command. This option allows inheritance of a value for user authentication from another group policy.

User authentication is disabled by default. When enabled, user authentication requires that individual users behind a hardware client authenticate to gain access to the network across the tunnel. Individual users authenticate according to the order of authentication servers that you configure.

If you require user authentication on the primary security appliance, be sure to configure it on any backup servers as well.

The following example shows how to enable user authentication for the group policy named “FirstGroup”:

```
hostname(config)# group-policy FirstGroup attributes
hostname(config-group-policy)# user-authentication enable
```

- Step 24** Set an idle timeout for individual users behind hardware clients, using the **user-authentication-idle-timeout** command in group-policy configuration mode.

```
hostname(config-group-policy)# user-authentication-idle-timeout {minutes | none}
hostname(config-group-policy)# no user-authentication-idle-timeout
```

The minutes parameter specifies the number of minutes in the idle timeout period. The minimum is 1 minute, the default is 30 minutes, and the maximum is 35791394 minutes.

To delete the idle timeout value, enter the **no** form of this command. This option allows inheritance of an idle timeout value from another group policy.

To prevent inheriting an idle timeout value, enter the **user-authentication-idle-timeout** command with the **none** keyword. This command sets the idle timeout with a null value, which disallows an idle timeout and prevents inheriting an user authentication idle timeout value from a default or specified group policy.

If there is no communication activity by a user behind a hardware client in the idle timeout period, the security appliance terminates the client’s access.



Note The **user-authentication-idle-timeout** command terminates only the client’s access through the VPN tunnel, not the VPN tunnel itself.

The following example shows how to set an idle timeout value of 45 minutes for the group policy named “FirstGroup”:

```
hostname(config)# group-policy FirstGroup attributes
hostname(config-group-policy)# user-authentication-idle-timeout 45
```

- Step 25** To enable IP Phone Bypass, enter the **ip-phone-bypass** command with the **enable** keyword in group-policy configuration mode. IP Phone Bypass lets IP phones behind hardware clients connect without undergoing user authentication processes. IP Phone Bypass is disabled by default. If enabled, secure unit authentication remains in effect.

To disable IP Phone Bypass, enter the **disable** keyword. To remove the IP phone Bypass attribute from the running configuration, enter the **no** form of this command. This option allows inheritance of a value for IP Phone Bypass from another group policy.

```
hostname(config-group-policy)# ip-phone-bypass {enable | disable}
hostname(config-group-policy)# no ip-phone-bypass
```

- Step 26** Specify whether to enable LEAP Bypass. To enable LEAP Bypass, enter the **leap-bypass** command with the **enable** keyword in group-policy configuration mode. To disable LEAP Bypass, enter the **disable** keyword. To remove the LEAP Bypass attribute from the running configuration, enter the **no** form of this command. This option allows inheritance of a value for LEAP Bypass from another group policy.

```
hostname(config-group-policy)# leap-bypass {enable | disable}
hostname(config-group-policy)# no leap-bypass
```

When LEAP Bypass is enabled, LEAP packets from wireless devices behind a VPN hardware client travel across a VPN tunnel prior to user authentication. This action lets workstations using Cisco wireless access point devices establish LEAP authentication and then authenticate again per user authentication. LEAP Bypass is disabled by default.



Note IEEE 802.1X is a standard for authentication on wired and wireless networks. It provides wireless LANs with strong mutual authentication between clients and authentication servers, which can provide dynamic per-user, per session wireless encryption privacy (WEP) keys, removing administrative burdens and security issues that are present with static WEP keys.

Cisco Systems has developed an 802.1X wireless authentication type called Cisco LEAP. LEAP (Lightweight Extensible Authentication Protocol) implements mutual authentication between a wireless client on one side of a connection and a RADIUS server on the other side. The credentials used for authentication, including a password, are always encrypted before they are transmitted over the wireless medium.

Cisco LEAP authenticates wireless clients to RADIUS servers. It does not include RADIUS accounting services.

This feature does not work as intended if you enable interactive hardware client authentication.



Caution

There might be security risks to your network in allowing any unauthenticated traffic to traverse the tunnel.

The following example shows how to set LEAP Bypass for the group policy named “FirstGroup”:

```
hostname(config)# group-policy FirstGroup attributes
hostname(config-group-policy)# leap-bypass enable
```

- Step 27** Enable network extension mode for hardware clients by entering the **nem** command with the **enable** keyword in group-policy configuration mode.

```
hostname(config-group-policy)# nem {enable | disable}
hostname(config-group-policy)# no nem
```

Network Extension mode lets hardware clients present a single, routable network to the remote private network over the VPN tunnel. IPSec encapsulates all traffic from the private network behind the hardware client to networks behind the security appliance. PAT does not apply. Therefore, devices

behind the security appliance have direct access to devices on the private network behind the hardware client over the tunnel, and only over the tunnel, and vice versa. The hardware client must initiate the tunnel, but after the tunnel is up, either side can initiate data exchange.

To disable NEM, enter the **disable** keyword. To remove the NEM attribute from the running configuration, enter the **no** form of this command. This option allows inheritance of a value from another group policy.

The following example shows how to set NEM for the group policy named “FirstGroup”:

```
hostname(config)# group-policy FirstGroup attributes
hostname(config-group-policy)# nem enable
```

Step 28 Configure backup servers if you plan on using them. IPsec backup servers let a VPN client connect to the central site when the primary security appliance is unavailable. To configure backup servers, enter the **backup-servers** command in group-policy configuration mode.

```
hostname(config-group-policy)# backup-servers {server1 server2... server10 |
clear-client-config | keep-client-config}
```

When you configure backup servers, the security appliance pushes the server list to the client as the IPsec tunnel is established. Backup servers do not exist until you configure them, either on the client or on the primary security appliance.

To remove a backup server, enter the **no** form of this command. To remove the backup-servers attribute from the running configuration and enable inheritance of a value for backup-servers from another group policy, enter the **no** form of this command without arguments.

```
hostname(config-group-policy)# no backup-servers [server1 server2... server10 |
clear-client-config | keep-client-config]
```

The **clear-client-config** keyword specifies that the client uses no backup servers. The security appliance pushes a null server list.

The **keep-client-config** keyword specifies that the security appliance sends no backup server information to the client. The client uses its own backup server list, if configured. This is the default.

The *server1 server 2... server10* parameter list is a space-delimited, priority-ordered list of servers for the VPN client to use when the primary security appliance is unavailable. This list identifies servers by IP address or hostname. The list can be 500 characters long, but it can contain only 10 entries.

Configure backup servers either on the client or on the primary security appliance. If you configure backup servers on the security appliance, it pushes the backup server policy to the clients in the group, replacing the backup server list on the client if one is configured.



Note If you are using hostnames, it is wise to have backup DNS and WINS servers on a separate network from that of the primary DNS and WINS servers. Otherwise, if clients behind a hardware client obtain DNS and WINS information from the hardware client via DHCP, and the connection to the primary server is lost, and the backup servers have different DNS and WINS information, clients cannot be updated until the DHCP lease expires. In addition, if you use hostnames and the DNS server is unavailable, significant delays can occur.

The following example shows how to configure backup servers with IP addresses 10.10.10.1 and 192.168.10.14, for the group policy named “FirstGroup”:

```
hostname(config)# group-policy FirstGroup attributes
hostname(config-group-policy)# backup-servers 10.10.10.1 192.168.10.14
```

Step 29 Set personal firewall policies that the security appliance pushes to the VPN client during IKE tunnel negotiation by using the **client-firewall** command in group-policy configuration mode. To delete a firewall policy, enter the **no** form of this command.

To delete all firewall policies, enter the **no client-firewall** command without arguments. This command deletes all configured firewall policies, including a null policy if you created one by entering the **client-firewall** command with the **none** keyword.

When there are no firewall policies, users inherit any that exist in the default or other group policy. To prevent users from inheriting such firewall policies, enter the **client-firewall** command with the **none** keyword.

Enter the following commands to set the appropriate client firewall parameters. [Table 25-1](#), following this set of commands, explains the syntax elements of these commands:

```
hostname(config-group-policy)# client-firewall none

hostname(config-group-policy)# client-firewall opt | req custom vendor-id num product-id num policy AYT | {CPP acl-in ACL acl-out ACL} [description string]

hostname(config-group-policy)# client-firewall opt | req zonelabs-zonealarm policy AYT | {CPP acl-in ACL acl-out ACL}

hostname(config-group-policy)# client-firewall opt | req zonelabs-zonealarmpro policy AYT | {CPP acl-in ACL acl-out ACL}

client-firewall opt | req zonelabs-zonealarmpro policy AYT | {CPP acl-in ACL acl-out ACL}

hostname(config-group-policy)# client-firewall opt | req cisco-integrated acl-in ACL acl-out ACL

hostname(config-group-policy)# client-firewall opt | req sygate-personal

hostname(config-group-policy)# client-firewall opt | req sygate-personal-pro

hostname(config-group-policy)# client-firewall opt | req sygate-security-agent

hostname(config-group-policy)# client-firewall opt | req networkkice-blackkice

hostname(config-group-policy)# client-firewall opt | req cisco-security-agent
```

Table 25-1 *client-firewall Command Parameters*

Parameter	Description
acl-in <ACL>	Provides the policy the client uses for inbound traffic.
acl-out <ACL>	Provides the policy the client uses for outbound traffic.
AYT	Specifies that the client PC firewall application controls the firewall policy. The security appliance checks to make sure that the firewall is running. It asks, “Are You There?” If there is no response, the security appliance tears down the tunnel.
cisco-integrated	Specifies Cisco Integrated firewall type.
cisco-security-agent	Specifies Cisco Intrusion Prevention Security Agent firewall type.
CPP	Specifies Policy Pushed as source of the VPN client firewall policy.
custom	Specifies Custom firewall type.
description <string>	Describes the firewall.
networkkice-blackkice	Specifies Network ICE Black ICE firewall type.

Table 25-1 *client-firewall Command Parameters (continued)*

none	Indicates that there is no client firewall policy. Sets a firewall policy with a null value, thereby disallowing a firewall policy. Prevents inheriting a firewall policy from a default or specified group policy.
opt	Indicates an optional firewall type.
product-id	Identifies the firewall product.
req	Indicates a required firewall type.
sygate-personal	Specifies Sygate Personal firewall type.
sygate-personal-pro	Specifies Sygate Personal Pro firewall type.
sygate-security-agent	Specifies Sygate Security Agent firewall type.
vendor-id	Identifies the firewall vendor.
zonelabs-zonealarm	Specifies Zone Labs Zone Alarm firewall type.
zonelabs-zonealarmorpro policy	Specifies Zone Labs Zone Alarm or Pro firewall type.
zonelabs-zonealarmpro policy	Specifies Zone Labs Zone Alarm Pro firewall type.

The following example shows how to set a client firewall policy that requires Cisco Intrusion Prevention Security Agent for the group policy named “FirstGroup”:

```
hostname(config)# group-policy FirstGroup attributes
hostname(config-group-policy)# client-firewall req cisco-security-agent
```

- Step 30** Configure rules that limit the remote access client types and versions that can connect via IPSec through the security appliance by using the **client-access-rule** command in group-policy configuration mode. To delete a rule, enter the **no** form of this command. This command is equivalent to the following command:

```
hostname(config-group-policy)# client-access-rule 1 deny type "Cisco VPN Client" version 4.0
```

To delete all rules, enter the **no client-access-rule command** without arguments. This deletes all configured rules, including a null rule if you created one by issuing the **client-access-rule** command with the **none** keyword.

By default, there are no access rules. When there are no client access rules, users inherit any rules that exist in the default group policy.

To prevent users from inheriting client access rules, enter the **client-access-rule** command with the **none** keyword. The result of this command is that all client types and versions can connect.

```
hostname(config-group-policy)# client-access rule priority {permit | deny} type type version {version | none}
```

```
hostname(config-group-policy)# no client-access rule [priority {permit | deny} type type version version]
```

Table 25-2 explains the meaning of the keywords and parameters in these commands.

Table 25-2 *client-access rule Command Parameters*

Parameter	Description
deny	Denies connections for devices of a particular type and/or version.
none	Allows no client access rules. Sets client-access-rule to a null value, thereby allowing no restriction. Prevents inheriting a value from a default or specified group policy.
permit	Permits connections for devices of a particular type and/or version.
priority	Determines the priority of the rule. The rule with the lowest integer has the highest priority. Therefore, the rule with the lowest integer that matches a client type and/or version is the rule that applies. If a lower priority rule contradicts, the security appliance ignores it.
type <i>type</i>	Identifies device types via free-form strings, for example VPN 3002. A string must match exactly its appearance in the show vpn-sessiondb remote display, except that you can enter the * character as a wildcard.
version <i>version</i>	Identifies the device version via free-form strings, for example 7.0. A string must match exactly its appearance in the show vpn-sessiondb remote display, except that you can enter the * character as a wildcard.

Construct rules according to these guidelines:

- If you do not define any rules, the security appliance permits all connection types.
- When a client matches none of the rules, the security appliance denies the connection. If you define a deny rule, you must also define at least one permit rule, or the security appliance denies all connections.
- For both software and hardware clients, type and version must match exactly their appearance in the **show vpn-sessiondb remote** display.
- The * character is a wildcard, which you can enter multiple times in each rule. For example, **client-access rule 3 deny type * version 3.*** creates a priority 3 client access rule that denies all client types running release versions 3.x software.
- You can construct a maximum of 25 rules per group policy.
- There is a limit of 255 characters for an entire set of rules.
- You can enter n/a for clients that do not send client type and/or version.

The following example shows how to create client access rules for the group policy named “FirstGroup”. These rules permit Cisco VPN clients running software version 4.x, while denying all Windows NT clients:

```
hostname(config)# group-policy FirstGroup attributes
hostname(config-group-policy)# client-access-rule 1 deny type WinNT version *
hostname(config-group-policy)# client-access-rule 2 permit "Cisco VPN Client" version 4.*
```



Note The “type” field is a free-form string that allows any value, but that value must match the fixed value that the client sends to the security appliance at connect time.

Step 31 Customize a WebVPN configuration for specific users or group policies. Enter `webvpn` mode by using the `webvpn` command in group-policy configuration mode. Webvpn commands for group policies define access to files, MAPI proxy, URLs and TCP applications over WebVPN. They also identify ACLs and types of traffic to filter. WebVPN is disabled by default.

To remove all commands entered in `webvpn` mode, enter the `no` form of this command. These `webvpn` commands apply to the username or group policy from which you configure them.

```
hostname(config-group-policy)# webvpn
hostname(config-group-policy)# no webvpn
```

You do not need to configure WebVPN to use e-mail proxies.

WebVPN lets users establish a secure, remote-access VPN tunnel to the security appliance using a web browser. There is no need for either a software or hardware client. WebVPN provides easy access to a broad range of web resources and web-enabled applications from almost any computer that can reach HTTPS Internet sites. WebVPN uses SSL and its successor, TLS1 to provide a secure connection between remote users and specific, supported internal resources that you configure at a central site. The security appliance recognizes connections that need to be proxied, and the HTTP server interacts with the authentication subsystem to authenticate users.



Note

The `webvpn` mode that you enter from global configuration mode lets you configure global settings for WebVPN. The `webvpn` mode described in this section, which you enter from group-policy mode, lets you customize a WebVPN configuration for specific group policies.

In `webvpn` mode, you can customize the following parameters, each of which is described in the subsequent steps:

- `functions url-entry`
- `html-content-filter`
- `homepage`
- `filter`
- `url-list`
- `port-forward`
- `port-forward-name` value Application Access

The following example shows how to enter `webvpn` mode for the group policy named “FirstGroup”:

```
hostname(config)# group-policy FirstGroup attributes
hostname(config-group-policy)# webvpn
hostname(config-username-webvpn)#
```

Step 32 Configure the WebVPN functions that you want to enable. To configure file access and file browsing, HTTP Proxy, MAPI Proxy, and URL entry over WebVPN for this group policy, enter the `functions` command in `webvpn` mode.

```
hostname(config-username-webvpn)# functions {file-access | file-browsing | file-entry |
http-proxy | url-entry | mapi | none}

hostname(config-username-webvpn)# no functions [file-access | file-browsing | file-entry |
http-proxy | url-entry | mapi]
```

To remove a configured function, enter the `no` form of this command. These functions are disabled by default.

To remove all configured functions, including a null value created by issuing the **functions none** command, enter the **no** form of this command without arguments. The **no** option allows inheritance of a value from another group policy. To prevent inheriting function values, enter the **functions none** command.

The following table describes the meaning of the keywords used in this command.

file-access	Enables or disables file access. When enabled, the WebVPN home page lists file servers in the server list. You must enable file access to enable file browsing and/or file entry.
file-browsing	Enables or disables browsing for file servers and shares. You must enable file browsing to allow user entry of a file server.
file-entry	Enables or disables user ability to enter names of file servers.
http-proxy	Enables or disables the forwarding of an HTTP applet proxy to the client. The proxy is useful for technologies that interfere with proper mangling, such as Java, ActiveX, and Flash. It bypasses mangling while ensuring the continued use of the security appliance. The forwarded proxy modifies the browser's old proxy configuration automatically and redirects all HTTP and HTTPS requests to the new proxy configuration. It supports virtually all client side technologies, including HTML, CSS, JavaScript, VBScript, ActiveX, and Java. The only browser it supports is Microsoft Internet Explorer.
mapi	Enables or disables Microsoft Outlook/Exchange port forwarding.
none	Sets a null value for all WebVPN functions . Prevents inheriting functions from a default or specified group policy
url-entry	Enables or disables user entry of URLs. When enabled, the security appliance still restricts URLs with any configured URL or network ACLs. When URL entry is disabled, the security appliance restricts WebVPN users to the URLs on the home page.

The following example shows how to configure file access, file browsing, and MAPI Proxy for the group policy named "FirstGroup":

```
hostname(config)# group-policy FirstGroup attributes
hostname(config-group-policy)# webvpn
hostname(config-username-webvpn)# functions file-access file-browsing MAPI
```

- Step 33** Specify whether to filter Java, ActiveX, images, scripts, and cookies for WebVPN sessions for this group policy by using the **html-content-filter** command in webvpn mode. To remove a content filter, enter the **no** form of this command. To remove all content filters, including a null value created by issuing the **html-content-filter** command with the **none** keyword, enter the **no** form of this command without arguments. The **no** option allows inheritance of a value from another group policy. To prevent inheriting an html content filter, enter the **html-content-filter** command with the **none** keyword. HTML filtering is disabled by default.

Using the command a second time overrides the previous setting.

```
hostname(config-username-webvpn)# html-content-filter {java | images | scripts | cookies | none}

hostname(config-username-webvpn)# no html-content-filter [java | images | scripts | cookies | none]
```

The following table describes the meaning of the keywords used in this command.

cookies	Removes cookies from images, providing limited ad filtering and privacy.
images	Removes references to images (removes tags).
java	Removes references to Java and ActiveX (removes <EMBED>, <APPLET>, and <OBJECT> tags).
none	Indicates that there is no filtering. Sets a null value, thereby disallowing filtering. Prevents inheriting filtering values.
scripts	Removes references to scripting (removes <SCRIPT> tags).

The following example shows how to set filtering of JAVA and ActiveX, cookies, and images for the group policy named “FirstGroup”:

```
hostname(config)# group-policy FirstGroup attributes
hostname(config-group-policy)# webvpn
hostname(config-username-webvpn)# html-content-filter java cookies images
```

- Step 34** Specify a URL for the web page that displays upon login for this WebVPN group policy by using the **homepage** command in webvpn mode. To remove a configured home page, including a null value created by issuing the **homepage none** command, enter the **no** form of this command. The **no** option allows inheritance of a value from another group policy. To prevent inheriting a home page, enter the **homepage none** command.

The **none** keyword indicates that there is no WebVPN home page. It sets a null value, thereby disallowing a home page and prevents inheriting an home page.

The *url-string* variable following the keyword **value** provides a URL for the home page. The string must begin with either `http://` or `https://`.

There is no default home page.

```
hostname(config-username-webvpn)# homepage {value url-string | none}
hostname(config-username-webvpn)# no homepage
```

- Step 35** Specify the name of the access list to use for WebVPN connections for this group policy or username by using the **filter** command in webvpn mode. To remove the access list, including a null value created by issuing the **filter none** command, enter the **no** form of this command. The **no** option allows inheritance of a value from another group policy. To prevent inheriting filter values, enter the **filter value none** command.

WebVPN access lists do not apply until you enter the **filter** command to specify them.

You configure ACLs to permit or deny various types of traffic for this group policy. You then enter the **filter** command to apply those ACLs for WebVPN traffic.

```
hostname(config-username-webvpn)# filter {value ACLname | none}
hostname(config-username-webvpn)# no filter
```

The **none** keyword indicates that there is no **webvpntype** access list. It sets a null value, thereby disallowing an access list and prevents inheriting an access list from another group policy.

The *ACLname* string following the keyword **value** provides the name of the previously configured access list.



Note

WebVPN does not use ACLs defined in the **vpn-filter** command.

The following example shows how to set a filter that invokes an access list named *acl_in* for the group policy named “FirstGroup”:

```
hostname(config)# group-policy FirstGroup attributes
hostname(config-group-policy)# webvpn
hostname(config-username-webvpn)# filter acl_in
```

- Step 36** To apply a list of WebVPN servers and URLs to a particular group policy, enter the **url-list** command in webvpn mode, which you enter from group-policy or username mode. To remove a list, including a null value created by using the **url-list** command with the **none** keyword, enter the **no** form of this command. The **no** option allows inheritance of a value from another group policy. To prevent inheriting a url list, enter the **url-list** command with the **none** keyword.

```
hostname(config-username-webvpn)# url-list {listname displayname url | none}
hostname(config-username-webvpn)# no url-list
```

The following table describes the meaning of the keywords and variables used in this command.

displayname	Specifies a name for the URL. This name appears on the WebVPN end user interface.
listname	Identifies a name by which to group URLs.
none	Indicates that there is no list of URLs. Sets a null value, thereby disallowing a URL list. Prevents inheriting URL list values.
url	Specifies a URL that WebVPN users can access.

There is no default URL list.

Using the command a second time overrides the previous setting.

Before you can enter the **url-list** command in webvpn mode to identify a URL list that you want to display on the WebVPN home page for a group policy, you must create the list. Enter the **url-list** command in global configuration mode to create one or more lists.

The following example shows how to set a URL list called “FirstGroupURLs” for the group policy named “FirstGroup”:

```
hostname(config)# group-policy FirstGroup attributes
hostname(config-group-policy)# webvpn
hostname(config-username-webvpn)# url-list value FirstGroupURLs
```

- Step 37** Enable WebVPN application access for this group policy by using the **port-forward** command in webvpn mode. To remove the port forwarding attribute from the configuration, including a null value created by issuing the **port-forward none** command, enter the **no** form of this command. The **no** option allows inheritance of a list from another group policy. To prevent inheriting a port forwarding list, enter the **port-forward** command with the **none** keyword.

```
hostname(config-username-webvpn)# port-forward {value listname | none}
hostname(config-username-webvpn)# no port-forward
```

The **none** keyword indicates that there is no filtering. It sets a null value, thereby disallowing a filtering, and prevents inheriting filtering values.

Port forwarding is disabled by default.

The *listname* string following the keyword **value** identifies the list of applications WebVPN users can access. Enter the port-forward command in configuration mode to define the list.

Using the command a second time overrides the previous setting.

Before you can enter the **port-forward** command in webvpn mode to enable application access, you must define a list of applications that you want users to be able to use in a WebVPN connection. Enter the **port-forward** command in global configuration mode to define this list.

The following example shows how to set a portforwarding list called *ports1* for the internal group policy named “FirstGroup”:

```
hostname(config)# group-policy FirstGroup internal attributes
hostname(config-group-policy)# webvpn
hostname(config-username-webvpn)# port-forward value ports1
```

- Step 38** Configure the display name that identifies TCP port forwarding to end users for a particular user or group policy by using the **port-forward-name** command in webvpn mode. To delete the display name, including a null value created by using the **port-forward-name none** command, enter the **no** form of the command. The **no** option restores the default name, “Application Access.” To prevent a display name, enter the **port-forward none** command.

```
hostname(config-username-webvpn)# port-forward-name {value name | none}
hostname(config-username-webvpn)# no port-forward-name
```

The following example shows how to set the name, “Remote Access TCP Applications,” for the internal group policy named “FirstGroup”:

```
hostname(config)# group-policy FirstGroup internal attributes
hostname(config-group-policy)# webvpn
hostname(config-username-webvpn)# port-forward-name value Remote Access TCP Applications
```

Configuring Users

By default, users inherit all user attributes from the assigned group policy. The security appliance also lets you assign individual attributes at the user level, overriding values in the group policy that applies to that user. For example, you can specify a group policy giving all users access during business hours, but give a specific user 24-hour access.

Viewing the Username Configuration

To display the configuration for all usernames, including default values inherited from the group policy, enter the **all** keyword with the **show running-config username** command, as follows:

```
hostname# show running-config all username
```

If you omit the **all** keyword, only explicitly configured values appear in this list. In this example, the usernames are “testuser” and “oliverw”. The configuration for all configured users, including the inherited values is as follows:

```
username testuser password 12RsxXQnphyr/I9Z encrypted privilege 15
username testuser attributes
  vpn-group-policy testing
  vpn-access-hours value averylongtime
  vpn-simultaneous-logins 4
  vpn-idle-timeout 30
  vpn-session-timeout none
  vpn-filter value tunneled
  no vpn-framed-ip-address
  group-lock value test
webvpn
  no functions
  html-content-filter java images scripts cookies
  no homepage
```

```

no filter
no url-list
no port-forward
no port-forward-name

username oliverw password vt/qgEzfgfrXXya4 encrypted privilege 2
username oliverw attributes
no vpn-group-policy
vpn-tunnel-protocol webvpn
no vpn-framed-ip-address
webvpn
functions url-entry file-access file-entry file-browsing
no html-content-filter
no homepage
no filter
no url-list
no port-forward
no port-forward-name
username cisco password 3USUcOPFUimCO4Jk encrypted privilege 15
username newuser nopassword privilege 15

```

Configuring Specific Users

To configure specific users, you assign a password (or no password) and attributes to a user using the **username** command, which enters username mode. Any attributes that you do not specify are inherited from the group policy.

The internal user authentication database consists of the users entered with the **username** command. The **login** command uses this database for authentication. To add a user to the security appliance database, enter the **username** command in global configuration mode. To remove a user, use the **no** version of this command with the username you want to remove. To remove all usernames, use the **clear configure username** command without appending a username.

Setting a User Password and Privilege Level

Use the **username** command to assign a password and a privilege level for a user. You can, instead, enter the **nopassword** keyword to specify that this user does not require a password. If you do specify a password, you can specify whether that password is stored in an encrypted form.

The optional privilege keyword lets you set a privilege level for this user. Privilege levels range from 0 (the lowest) through 15. System administrators generally have the highest privilege level. The default level is 2.

```

hostname(config)# username name {nopassword | password password [encrypted]} [privilege
priv_level]}

hostname(config)# no username [name]

```

The following table describes the meaning of the keywords and variables used in this command.

encrypted	Indicates that the password is encrypted.
<i>name</i>	Provides the name of the user.
nopassword	Indicates that this user needs no password.
password <i>password</i>	Indicates that this user has a password, and provides the password.
privilege <i>priv_level</i>	Sets a privilege level for this user. The range is from 0 to 15, with lower numbers having less ability to use commands and administer the security appliance. The default privilege level is 2. The typical privilege level for a system administrator is 15.

By default, VPN users that you add with this command have no attributes or group policy association. You must configure all values explicitly.

The following example shows how to configure a user named “anyuser” with a n encrypted password of pw_12345678 and a privilege level of 12:

```
hostname(config)# username anyuser password pw_12345678 encrypted privilege 12
```

Configuring User Attributes

After configuring the user’s password (if any) and privilege level, you set the other attributes. These can be in any order. To remove any attribute-value pair, enter the **no** form of the command.

Step 1 Enter username mode by entering the **username** command with the **attributes** keyword:

```
hostname(config)# username name attributes
hostname(config-username)#
```

The prompt changes to indicate the new mode. You can now configure the attributes.

Step 2 Specify the name of the group policy from which this user inherits attributes. By default, VPN users have no group policy association.

```
hostname(config-username)# vpn-group-policy group-policy-name
hostname(config-username)# no vpn-group-policy group-policy-name
```

Using this command lets users inherit attributes that you have not configured at the username level.

You can override the value of an attribute in a group policy for a particular user by configuring it in username mode, if that attribute is available in username mode.

The following example shows how to configure a user named “anyuser” to use attributes from the group policy named “FirstGroup”:

```
hostname(config)# username anyuser attributes
hostname(config-username)# vpn-group-policy FirstGroup
```

Step 3 Associate the hours that this user is allowed to access the system by specifying the name of a configured time-range policy:

To remove the attribute from the running configuration, enter the **no** form of this command. This option allows inheritance of a time-range value from another group policy. To prevent inheriting a value, enter the **vpn-access-hours none** command. The default is unrestricted access.

```
hostname(config-username)# vpn-access-hours value {time-range | none}
hostname(config-username)# vpn-access-hours value none
```

The following example shows how to associate the user named “anyuser” with a time-range policy called 824:

```
hostname(config)# username anyuser attributes
hostname(config-username)# vpn-access-hours 824
```

- Step 4** Specify the maximum number of simultaneous logins allowed for this user. The range is 0 through 2147483647. The default is 3 simultaneous logins. To remove the attribute from the running configuration, enter the **no** form of this command. Enter 0 to disable login and prevent user access.

```
hostname(config-username)# vpn-simultaneous-logins integer
hostname(config-username)# no vpn-simultaneous-logins
```

The following example shows how to allow a maximum of 4 simultaneous logins for the user named “anyuser”:

```
hostname(config)# username anyuser attributes
hostname(config-username)# vpn-simultaneous-logins 4
```

- Step 5** Specify the idle timeout period in minutes, or enter **none** to disable the idle timeout. If there is no communication activity on the connection in this period, the security appliance terminates the connection.

The range is 1 through 35791394 minutes. The default is 30 minutes. To allow an unlimited timeout period, and thus prevent inheriting a timeout value, enter the **vpn-idle-timeout** command with the **none** keyword. To remove the attribute from the running configuration, enter the **no** form of this command.

```
hostname(config-username)# vpn-idle-timeout {minutes | none}
hostname(config-username)# no vpn-idle-timeout
```

The following example shows how to set a VPN idle timeout of 15 minutes for the user named “anyuser”:

```
hostname(config)# username anyuser attributes
hostname(config-username)# vpn-idle-timeout 30
```

- Step 6** Specify the maximum user connection time in minutes, or enter **none** to allow unlimited connection time and prevent inheriting a value for this attribute. At the end of this period of time, the security appliance terminates the connection.

The range is 1 through 35791394 minutes. There is no default timeout. To allow an unlimited timeout period, and thus prevent inheriting a timeout value, enter the **vpn-session-timeout** command with the **none** keyword. To remove the attribute from the running configuration, enter the **no** form of this command.

```
hostname(config-username)# vpn-session-timeout {minutes | none}
hostname(config-username)# no vpn-session-timeout
```

The following example shows how to set a VPN session timeout of 180 minutes for the user named “anyuser”:

```
hostname(config)# username anyuser attributes
hostname(config-username)# vpn-session-timeout 180
```

- Step 7** Specify the name of a previously-configured, user-specific ACL to use as a filter for VPN connections. To disallow an access list and prevent inheriting an access list from the group policy, enter the **vpn-filter** command with the **none** keyword. To remove the ACL, including a null value created by issuing the **vpn-filter none** command, enter the **no** form of this command. The **no** option allows inheritance of a value from the group policy. There are no default behaviors or values for this command.

You configure ACLs to permit or deny various types of traffic for this user. You then use the **vpn-filter** command to apply those ACLs.

```
hostname(config-username)# vpn-filter {value ACL name | none}
hostname(config-username)# no vpn-filter
```



Note WebVPN does not use the ACL defined in the **vpn-filter** command.

The following example shows how to set a filter that invokes an access list named “acl_vpn” for the user named “anyuser”:

```
hostname(config)# username anyuser attributes
hostname(config-username)# vpn-filter value acl_vpn
```

Step 8 Specify the IP address and netmask to assign to a particular user. To remove the IP address, enter the **no** form of this command.

```
hostname(config-username)# vpn-framed-ip-address {ip_address}
hostname(config-username)# no vpn-framed-ip-address
```

The following example shows how to set an IP address of 10.92.166.7 for a user named “anyuser”:

```
hostname(config)# username anyuser attributes
hostname(config-username)# vpn-framed-ip-address 10.92.166.7
```

Step 9 Specify the network mask to use with the IP address specified in the previous step. If you used the **no vpn-framed-ip-address** command, do not specify a network mask. To remove the subnet mask, enter the **no** form of this command. There is no default behavior or value.

```
hostname(config-username)# vpn-framed-ip-netmask {netmask}
hostname(config-username)# no vpn-framed-ip-netmask
```

The following example shows how to set a subnet mask of 255.255.255.254 for a user named “anyuser”:

```
hostname(config)# username anyuser attributes
hostname(config-username)# vpn-framed-ip-netmask 255.255.255.254
```

Step 10 Specify the VPN tunnel types (IPSec or WebVPN) that this user can use. The default is taken from the default group policy, the default for which is IPSec. To remove the attribute from the running configuration, enter the **no** form of this command.

```
hostname(config-username)# vpn-tunnel-protocol {webvpn | IPSec}
hostname(config-username)# no vpn-tunnel-protocol [webvpn | IPSec]
```

The parameter values for this command are as follows:

- **IPSec**—Negotiates an IPSec tunnel between two peers (a remote access client or another secure gateway). Creates security associations that govern authentication, encryption, encapsulation, and key management.
- **webvpn**—Provides VPN services to remote users via an HTTPS-enabled web browser, and does not require a client

Enter this command to configure one or more tunneling modes. You must configure at least one tunneling mode for users to connect over a VPN tunnel.

The following example shows how to configure WebVPN and IPSec tunneling modes for the user named “anyuser”:

```
hostname(config)# username anyuser attributes
hostname(config-username)# vpn-tunnel-protocol webvpn
hostname(config-username)# vpn-tunnel-protocol IPSec
```

- Step 11** Configure the **group-lock** attribute with the **value** keyword to restrict remote users to access only through the specified, preexisting tunnel group. To remove the **group-lock** attribute from the running configuration, enter the **no** form of this command. This option allows inheritance of a value from the group policy. To disable group-lock, and to prevent inheriting a group-lock value from a default or specified group policy, enter the **group-lock** command with the **none** keyword.

Group-lock restricts users by checking whether the group configured in the VPN client is the same as the tunnel group to which the user is assigned. If it is not, the security appliance prevents the user from connecting. If you do not configure group-lock, the security appliance authenticates users without regard to the assigned group.

```
hostname(config-username)# group-lock {value tunnel-grp-name | none}
hostname(config-username)# no group-lock
```

The following example shows how to set group lock for the user named “anyuser”:

```
hostname(config)# username anyuser attributes
hostname(config-username)# group-lock value tunnel group name
```

- Step 12** Specify whether to let users store their login passwords on the client system. Password storage is disabled by default. Enable password storage only on systems that you know to be in secure sites. To disable password storage, enter the **password-storage** command with the **disable** keyword. To remove the password-storage attribute from the running configuration, enter the **no** form of this command. This enables inheritance of a value for password-storage from the group policy.

```
hostname(config-username)# password-storage {enable | disable}
hostname(config-username)# no password-storage
```

This command has no bearing on interactive hardware client authentication or individual user authentication for hardware clients.

The following example shows how to enable password storage for the user named “anyuser”:

```
hostname(config)# username anyuser attributes
hostname(config-username)# password-storage enable
```

- Step 13** Customize a WebVPN configuration for specific users. Enter webvpn mode by using the **webvpn** command in username configuration mode. The **webvpn** commands for usernames define access to files, MAPI proxy, URLs and TCP applications over WebVPN. They also identify ACLs and types of traffic to filter. WebVPN is disabled by default.

To remove all commands entered in webvpn mode, use the **no** form of this command. These **webvpn** commands apply to the username from which you configure them.

```
hostname(config-username)# webvpn
hostname(config-username)# no webvpn
```

You do not need to configure WebVPN to use e-mail proxies.

WebVPN lets users establish a secure, remote-access VPN tunnel to the security appliance using a web browser. There is no need for either a software or hardware client. WebVPN provides easy access to a broad range of web resources and web-enabled applications from almost any computer that can reach HTTPS Internet sites. WebVPN uses SSL and its successor, TLS1 to provide a secure connection between remote users and specific, supported internal resources that you configure at a central site. The security appliance recognizes connections that need to be proxied, and the HTTP server interacts with the authentication subsystem to authenticate users.

**Note**

The `webvpn` mode that you enter from global configuration mode lets you configure global settings for WebVPN. The `webvpn` mode described in this section, which you enter from username mode, lets you customize a WebVPN configuration for specific users.

In `webvpn` mode, you can customize the following parameters, each of which is described in the subsequent steps:

- `functions url-entry`
- `html-content-filter`
- `homepage`
- `filter`
- `url-list`
- `port-forward`
- `port-forward-name` value Application Access

The following example shows how to enter `webvpn` mode for the username “anyuser” attributes:

```
hostname(config)# username anyuser attributes
hostname(config-username)# webvpn
hostname(config-username-webvpn)#
```

- Step 14** Configure the WebVPN functions you want to enable. To configure file access and file browsing, HTTP Proxy, MAPI Proxy, and URL entry over WebVPN for this user, enter the **functions** command in `webvpn` mode. To remove a configured function, enter the **no** form of this command. These functions are disabled by default.

To remove all configured functions, including a null value created by issuing the **functions none** command, enter the **no** form of this command without arguments. The **no** option allows inheritance of a value from another group policy. To prevent inheriting function values, enter the **functions none** command.

```
hostname(config-username-webvpn)# functions {file-access | file-browsing | file-entry |
http-proxy | url-entry | mapi | none}

hostname(config-username-webvpn)# no functions [file-access | file-browsing | file-entry |
http-proxy | url-entry | mapi]
```

The keywords used in this command are as follows:

- **file-access**—Enables or disables file access. When enabled, the WebVPN home page lists file servers in the server list. You must enable file access to enable file browsing and/or file entry.
- **file-browsing**—Enables or disables browsing for file servers and shares. You must enable file browsing to allow user entry of a file server.
- **file-entry**—Enables or disables user ability to enter names of file servers.
- **http-proxy**—Enables or disables the forwarding of an HTTP applet proxy to the client. The proxy is useful for technologies that interfere with proper mangling, such as Java, ActiveX, and Flash. It bypasses mangling while ensuring the continued use of the security appliance. The forwarded proxy modifies the browser’s old proxy configuration automatically and redirects all HTTP and HTTPS requests to the new proxy configuration. It supports virtually all client side technologies, including HTML, CSS, JavaScript, VBScript, ActiveX, and Java. The only browser it supports is Microsoft Internet Explorer.

- **mapi**—Enables or disables Microsoft Outlook/Exchange port forwarding.
- **none**—Sets a null value for all WebVPN **functions**. Prevents inheriting functions from a default or specified group policy
- **url-entry**—Enables or disables user entry of URLs. When enabled, the security appliance still restricts URLs with any configured URL or network ACLs. When URL entry is disabled, the security appliance restricts WebVPN users to the URLs on the home page.

The following example shows how to configure file access, file browsing, HTTP Proxy, and MAPI Proxy for the user named “anyuser”:

```
hostname(config)# username anyuser attributes
hostname(config-username)# webvpn
hostname(config-username-webvpn)# functions file-access file-browsing MAPI
```

- Step 15** To filter Java, ActiveX, images, scripts, and cookies for WebVPN sessions for this user, enter the **html-content-filter** command in webvpn mode. To remove a content filter, enter the **no** form of this command. To remove all content filters, including a null value created by issuing the **html-content-filter none** command, enter the **no** form of this command without arguments. The **no** option allows inheritance of a value from the group policy. To prevent inheriting an HTML content filter, enter the **html-content-filter none** command. HTML filtering is disabled by default.

Using the command a second time overrides the previous setting.

```
hostname(config-username-webvpn)# html-content-filter {java | images | scripts | cookies | none}

hostname(config-username-webvpn)# no html-content-filter [java | images | scripts | cookies | none]
```

The keywords used in this command are as follows:

- **cookies**—Removes cookies from images, providing limited ad filtering and privacy.
- **images**—Removes references to images (removes tags).
- **java**—Removes references to Java and ActiveX (removes <EMBED>, <APPLET>, and <OBJECT> tags).
- **none**—Indicates that there is no filtering. Sets a null value, thereby disallowing filtering. Prevents inheriting filtering values.
- **scripts**—Removes references to scripting (removes <SCRIPT> tags).

The following example shows how to set filtering of JAVA and ActiveX, cookies, and images for the user named “anyuser”:

```
hostname(config)# username anyuser attributes
hostname(config-username)# webvpn
hostname(config-username-webvpn)# html-content-filter java cookies images
```

- Step 16** To specify a URL for the web page that displays upon login for this WebVPN user, enter the **homepage** command in webvpn mode. To remove a configured home page, including a null value created by issuing the **homepage none** command, enter the **no** form of this command. The **no** option allows inheritance of a value from the group policy. To prevent inheriting a home page, enter the **homepage none** command.

The **none** keyword indicates that there is no WebVPN home page. It sets a null value, thereby disallowing a home page and prevents inheriting a home page.

The *url-string* variable following the keyword **value** provides a URL for the home page. The string must begin with either http:// or https://.

There is no default home page.

```
hostname(config-username-webvpn)# homepage {value url-string | none}
hostname(config-username-webvpn)# no homepage
```

The following example shows how to specify www.example.com as the home page for the user named “anyuser”:

```
hostname(config)# username anyuser attributes
hostname(config-username)# webvpn
hostname(config-username-webvpn)# homepage value www.example.com
```

- Step 17** To specify the name of the access list to use for WebVPN connections for this user, enter the **filter** command in webvpn mode. To remove the access list, including a null value created by issuing the **filter none** command, enter the **no** form of this command. The **no** option allows inheritance of a value from the group policy. To prevent inheriting filter values, enter the **filter value none** command.

WebVPN access lists do not apply until you enter the **filter** command to specify them.

You configure ACLs to permit or deny various types of traffic for this user. You then enter the **filter** command to apply those ACLs for WebVPN traffic.

```
hostname(config-username-webvpn)# filter {value ACLname | none}
hostname(config-username-webvpn)# no filter
```

The **none** keyword indicates that there is no **webvpntype** access list. It sets a null value, thereby disallowing an access list and prevents inheriting an access list from another group policy.

The *ACLname* string following the keyword **value** provides the name of the previously configured access list.



Note

WebVPN does not use ACLs defined in the **vpn-filter** command.

The following example shows how to set a filter that invokes an access list named *acl_in* for the user named “anyuser”:

```
hostname(config)# username anyuser attributes
hostname(config-username)# webvpn
hostname(config-username-webvpn)# filter acl_in
```

- Step 18** To apply a list of WebVPN servers and URLs to a particular user, enter the **url-list** command in webvpn mode. To remove a list, including a null value created by using the **url-list none** command, enter the **no** form of this command. The **no** option allows inheritance of a value from the group policy. To prevent inheriting a url list, enter the **url-list none** command.

```
hostname(config-username-webvpn)# url-list {listname displayname url | none}
hostname(config-username-webvpn)# no url-list
```

The keywords and variables used in this command are as follows:

- *displayname*—Specifies a name for the URL. This name appears on the WebVPN end user interface.
- *listname*—Identifies a name by which to group URLs.
- **none**—Indicates that there is no list of URLs. Sets a null value, thereby disallowing a URL list. Prevents inheriting URL list values.
- *url*—Specifies a URL that WebVPN users can access.

There is no default URL list.

Using the command a second time overrides the previous setting.

Before you can enter the **url-list** command in webvpn mode to identify a URL list that you want to display on the WebVPN home page for a user, you must create the list. Enter the **url-list** command in global configuration mode to create one or more lists.

The following example shows how to set a URL list called “AnyuserURLs” for the user named “anyuser”:

```
hostname(config)# username anyuser attributes
hostname(config-username)# webvpn
hostname(config-username-webvpn)# url-list value AnyuserURLs
```

- Step 19** To enable WebVPN application access for this user, enter the **port-forward** command in webvpn mode. To remove the port forwarding attribute from the configuration, including a null value created by issuing the **port-forward none** command, enter the **no** form of this command. The **no** option allows inheritance of a list from the group policy. To disallow filtering and prevent inheriting a port forwarding list, enter the **port-forward** command with the **none** keyword.

Port forwarding is disabled by default.

```
hostname(config-username-webvpn)# port-forward {value listname | none}
hostname(config-username-webvpn)# no port-forward
```

The *listname* string following the keyword **value** identifies the list of applications WebVPN users can access. Enter the **port-forward** command in configuration mode to define the list.

Using the command a second time overrides the previous setting.

Before you can enter the **port-forward** command in webvpn mode to enable application access, you must define a list of applications that you want users to be able to use in a WebVPN connection. Enter the **port-forward** command in global configuration mode to define this list.

The following example shows how to configure a portforwarding list called “ports1”:

```
hostname(config-group-policy)# webvpn
hostname(config-username-webvpn)# port-forward value ports1
```

- Step 20** Configure the display name that identifies TCP port forwarding to end users for a particular user by using the **port-forward-name** command in webvpn mode. To delete the display name, including a null value created by using the **port-forward-name none** command, enter the **no** form of the command. The **no** option restores the default name, “Application Access.” To prevent a display name, enter the **port-forward none** command.

```
hostname(config-username-webvpn)# port-forward-name {value name | none}
hostname(config-username-webvpn)# no port-forward-name
```

The following example shows how to configure the port-forward name “test”:

```
hostname(config-group-policy)# webvpn
hostname(config-username-webvpn)# port-forward-name value test
```



Configuring IP Addresses for VPNs

This chapter describes IP address assignment methods.

IP addresses make internetwork connections possible. They are like telephone numbers: both the sender and receiver must have an assigned number to connect. But with VPNs, there are actually two sets of addresses: the first set connects client and server on the public network. Once that connection is made, the second set connects client and server through the VPN tunnel.

In security appliance address management, we are dealing with the second set of IP addresses: those private IP addresses that connect a client with a resource on the private network, through the tunnel, and let the client function as if it were directly connected to the private network. Furthermore, we are dealing only with the private IP addresses that get assigned to clients. The IP addresses assigned to other resources on your private network are part of your network administration responsibilities, not part of VPN management. Therefore, when we discuss IP addresses here, we mean those IP addresses available in your private network addressing scheme that let the client function as a tunnel endpoint.

This chapter includes the following sections:

[Configuring an IP Address Assignment Method, page 1](#)

[Configuring Local IP Address Pools, page 2](#)

[Configuring AAA Addressing, page 2](#)

[Configuring DHCP Addressing, page 3](#)

Configuring an IP Address Assignment Method

The security appliance can use one or more of the following methods for assigning IP addresses to remote access clients. If you configure more than one address assignment method, the security appliance searches each of the options until it finds an IP address. By default, all methods are enabled. To view the current configuration, enter the **show running-config all vpn-addr-assign** command.

- **aaa**—Retrieves addresses from an external authentication server on a per-user basis. If you are using an authentication server that has IP addresses configured, we recommend using this method.
- **dhcp**—Obtains IP addresses from a DHCP server. If you want to use DHCP, you must configure a DHCP server. You must also define the range of IP addresses that the DHCP server can use.
- **local**—Use an internal address pool. Internally configured address pools are the easiest method of address pool assignment to configure. If you choose local, you must also use the **ip-local-pool** command to define the range of IP addresses to use.

To specify a method for assigning IP addresses to remote access clients, enter the **vpn-addr-assign** command in global configuration mode. The syntax is **vpn-addr-assign {aaa | dhcp | local}**.

Configuring Local IP Address Pools

To configure IP address pools to use for VPN remote access tunnels, enter the **ip local pool** command in global configuration mode. To delete address pools, enter the **no** form of this command.

The security appliance uses address pools based on the tunnel group for the connection. If you configure more than one address pool for a tunnel group, the security appliance uses them in the order in which they are configured.

If you assign addresses from a non-local subnet, we suggest that you add pools that fall on subnet boundaries to make adding routes for these networks easier.

A summary of the configuration of local address pools follows:

```
hostname(config)# vpn-addr-assign local
hostname(config)# ip local pool firstpool 10.20.30.40-10.20.30.50 mask 255.255.255.0
hostname(config)
```

-
- Step 1** To configure IP address pools as the address assignment method, enter the **vpn-addr-assign** command with the **local** argument:

```
hostname(config)# vpn-addr-assign local
hostname(config)#
```

- Step 2** To configure an address pool, enter the **ip local pool** command. The syntax is **ip local pool poolname first-address—last-address mask mask**.

The following example configures an IP address pool named firstpool. The starting address is 10.20.30.40 and the ending address is 10.20.30.50. The network mask is 255.255.255.0.

```
hostname(config)# ip local pool firstpool 10.20.30.40-10.20.30.50 mask 255.255.255.0
hostname(config)
```

Configuring AAA Addressing

To use a AAA server to assign addresses for VPN remote access clients, you must first configure a AAA server or server group. See the **aaa-server protocol** command in the *Cisco Security Appliance Command Reference* and “Identifying AAA Server Groups and Servers,” in Chapter 10, “Configuring AAA Servers and the Local Database” of this guide.

In addition, the user must match a tunnel group configured for RADIUS authentication.

The following examples illustrate how to define a AAA server group called RAD2 for the tunnel group named firstgroup. It includes one more step than is necessary, in that previously you might have named the tunnel group and define the tunnel group type. This step appears in the following example as a reminder that you have no access to subsequent tunnel-group commands until you set these values.

A summary of the configuration that these examples create follows:

```
hostname(config)# vpn-addr-assign aaa
hostname(config)# tunnel-group firstgroup type ipsec-ra
hostname(config)# tunnel-group firstgroup general-attributes
hostname(config-general)# authentication-server-group RAD2
```

To configure AAA for IP addressing, perform the following steps:

- Step 1** To configure AAA as the address assignment method, enter the **vpn-addr-assign** command with the **aaa** argument:

```
hostname(config)# vpn-addr-assign aaa
hostname(config)#
```

- Step 2** To establish the tunnel group called firstgroup as a remote access or LAN-to-LAN tunnel group, enter the **tunnel-group** command with the **type** keyword. The following example configures a remote access tunnel group.

```
hostname(config)# tunnel-group firstgroup type ipsec-ra
hostname(config)#
```

- Step 3** To enter general-attributes configuration mode, which lets you define a AAA server group for the tunnel group called firstgroup, enter the **tunnel-group** command with the **general-attributes** argument.

```
hostname(config)# tunnel-group firstgroup general-attributes
hostname(config-general)#
```

- Step 4** To specify the AAA server group to use for authentication, enter the **authentication-server-group** command.

```
hostname(config-general)# authentication-server-group RAD2
hostname(config-general)#
```

This command has more arguments that this example includes. For more information, see the *Cisco Security Appliance Command Reference*.

Configuring DHCP Addressing

To use DHCP to assign addresses for VPN clients, you must first configure a DHCP server and the range of IP addresses that the DHCP server can use. Then you define the DHCP server on a tunnel group basis. Optionally, you can also define a DHCP network scope in the group policy associated with the tunnel group or username. This is either an IP network number or IP Address that identifies to the DHCP server which pool of IP addresses to use.

The following examples define the DHCP server at IP address 172.33.44.19 for the tunnel group named firstgroup. They also define a DHCP network scope of 192.86.0.0 for the group policy called remotegroup. (The group policy called remotegroup is associated with the tunnel group called firstgroup). If you do not define a network scope, the DHCP server assigns IP addresses in the order of the address pools configured. It goes through the pools until it identifies an unassigned address.

The following configuration includes more steps than are necessary, in that previously you might have named and defined the tunnel group type as remote access, and named and identified the group policy as internal or external. These steps appear in the following examples as a reminder that you have no access to subsequent tunnel-group and group-policy commands until you set these values.

A summary of the configuration that these examples create follows:

```
hostname(config)# vpn-addr-assign dhcp
hostname(config)# tunnel-group firstgroup type ipsec-ra
hostname(config)# tunnel-group firstgroup general-attributes
hostname(config-general)# dhcp-server 172.33.44.19
hostname(config-general)# exit
hostname(config)# group-policy remotegroup internal
```

```
hostname(config)# group-policy remotegroup attributes
hostname(config-group-policy)# dhcp-network-scope 192.86.0.0
```

To define a DHCP server for IP addressing, perform the following steps.

-
- Step 1** To configure DHCP as the address assignment method, enter the **vpn-addr-assign** command with the **dhcp** argument:
- ```
hostname(config)# vpn-addr-assign dhcp
hostname(config)#
```
- Step 2** To establish the tunnel group called firstgroup as a remote access or LAN-to-LAN tunnel group, enter the **tunnel-group** command with the **type** keyword. The following example configures a remote access tunnel group.
- ```
hostname(config)# tunnel-group firstgroup type ipsec-ra
hostname(config)#
```
- Step 3** To enter general-attributes configuration mode, which lets you configure a DHCP server, enter the **tunnel-group** command with the **general-attributes** argument.
- ```
hostname(config)# tunnel-group firstgroup general-attributes
hostname(config)#
```
- Step 4** To define the DHCP server, enter the **dhcp-server** command. The following example configures a DHCP server at IP address 172.33.44.19.
- ```
hostname(config-general)# dhcp-server 172.33.44.19
hostname(config-general)#
```
- Step 5** Exit tunnel-group mode.
- ```
hostname(config-general)# exit
hostname(config)#
```
- Step 6** To define the group policy called remotegroup as an internally or externally configured group, enter the **group-policy** command with the **internal** or **external** argument. The following example configures an internal group.
- ```
hostname(config)# group-policy remotegroup internal
hostname(config)#
```
- Step 7** (Optional) To enter group-policy attributes configuration mode, which lets you configure a subnetwork of IP addresses for the DHCP server to use, enter the **group-policy** command with the **attributes** keyword.
- ```
hostname(config)# group-policy remotegroup attributes
hostname(config-group-policy)#
```
- Step 8** (Optional) To specify the range of IP addresses the DHCP server should use to assign addresses to users of the group policy called remotegroup, enter the **dhcp-network-scope** command. The following example configures at network scope of 192.86.0.0.
- ```
hostname(config-group-policy)# dhcp-network-scope 192.86.0.0
hostname(config-group-policy)#
```
-



Configuring Remote Access VPNs

Remote access VPNs let single users connect to a central site through a secure connection over a TCP/IP network such as the Internet.

This chapter describes how to build a remote access VPN connection. It includes the following sections:

- [Summary of the Configuration, page 27-1](#)
- [Configuring Interfaces, page 27-2](#)
- [Configuring ISAKMP Policy and Enabling ISAKMP on the Outside Interface, page 27-3](#)
- [Configuring an Address Pool, page 27-4](#)
- [Adding a User, page 27-4](#)
- [Creating a Transform Set, page 27-4](#)
- [Defining a Tunnel Group, page 27-5](#)
- [Creating a Dynamic Crypto Map, page 27-6](#)
- [Creating a Crypto Map Entry to Use the Dynamic Crypto Map, page 27-7](#)

Summary of the Configuration

This chapter uses the following configuration to explain how to configure a remote access connection. Later sections provide step-by-step instructions.

```
hostname(config)# interface ethernet0
hostname(config-if)# ip address 10.10.4.200 255.255.0.0
hostname(config-if)# nameif outside
hostname(config)# no shutdown
hostname(config)# isakmp policy 1 authentication pre-share
hostname(config)# isakmp policy 1 encryption 3des
hostname(config)# isakmp policy 1 hash sha
hostname(config)# isakmp policy 1 group 2
hostname(config)# isakmp policy 1 lifetime 43200
hostname(config)# isakmp enable outside
hostname(config)# ip local pool testpool 192.168.0.10-192.168.0.15
hostname(config)# username testuser password 12345678
hostname(config)# crypto ipsec transform set FirstSet esp-3des esp-md5-hmac
hostname(config)# tunnel-group testgroup type ipsec-ra
hostname(config)# tunnel-group testgroup general-attributes
hostname(config-general)# address-pool testpool
hostname(config)# tunnel-group testgroup ipsec-attributes
hostname(config-ipsec)# pre-shared-key 44kkaol59636jnfxf
hostname(config)# crypto dynamic-map dyn1 1 set transform-set FirstSet
```

```
hostname(config)# crypto dynamic-map dyn1 1 set reverse-route
hostname(config)# crypto map mymap 1 ipsec-isakmp dynamic dyn1
hostname(config)# crypto map mymap interface outside
hostname(config)# write memory
```

Configuring Interfaces

A security appliance has at least two interfaces, referred to here as outside and inside. Typically, the outside interface is connected to the public Internet, while the inside interface is connected to a private network and is protected from public access.

To begin, configure and enable two interfaces on the security appliance. Then assign a name, IP address and subnet mask. Optionally, configure its security level, speed and duplex operation on the security appliance.

To configure interfaces, perform the following steps, using the command syntax in the examples:

-
- Step 1** To enter Interface configuration mode, in global configuration mode enter the **interface** command with the default name of the interface to configure. In the following example the interface is ethernet0.

```
hostname(config)# interface ethernet0
hostname(config-if)#
```

- Step 2** To set the IP address and subnet mask for the interface, enter the **ip address** command. In the following example the IP address is 10.10.4.100 and the subnet mask is 255.255.0.0.

```
hostname(config-if)# ip address 10.10.4.200 255.255.0.0
hostname(config-if)#
```

- Step 3** To name the interface, enter the **nameif** command, maximum of 48 characters. You cannot change this name after you set it. In the following example the name of the ethernet0 interface is outside.

```
hostname(config-if)# nameif outside
hostname(config-if)##
```

- Step 4** To enable the interface, enter the **no** version of the **shutdown** command. By default, interfaces are disabled.

```
hostname(config-if)# no shutdown
hostname(config-if)#
```

- Step 5** To save your changes, enter the **write memory** command.

```
hostname(config-if)# write memory
hostname(config-if)#
```

- Step 6** To configure a second interface, use the same procedure.
-

Configuring ISAKMP Policy and Enabling ISAKMP on the Outside Interface

The Internet Security Association and Key Management Protocol, also called IKE, is the negotiation protocol that lets two hosts agree on how to build an IPsec Security Association. Each ISAKMP negotiation is divided into two sections called Phase 1 and Phase 2.

Phase 1 creates the first tunnel to protect later ISAKMP negotiation messages. Phase 2 creates the tunnel that protects data travelling across the secure connection.

To set the terms of the ISAKMP negotiations, you create an ISAKMP policy. It includes the following:

- An authentication method, to ensure the identity of the peers.
- An encryption method, to protect the data and ensure privacy.
- A Hashed Message Authentication Codes method to ensure the identity of the sender and to ensure that the message has not been modified in transit.
- A Diffie-Hellman group to set the size of the encryption key.
- A time limit for how long the security appliance uses an encryption key before replacing it.

See [on page 23-3](#) in the “Configuring IPsec and ISAKMP” chapter of this guide for detailed information about the IKE policy keywords and their values.

To configure ISAKMP policies, in global configuration mode, enter the **isakmp policy** command with its various arguments. The syntax for ISAKMP policy commands is **isakmp policy priority attribute_name [attribute_value | integer]**.

Perform the following steps and use the command syntax in the following examples as a guide.

Step 1 Set the authentication method. The following example configures preshared key. The priority is 1 in this and all following steps.

```
hostname(config)# isakmp policy 1 authentication pre-share
hostname(config)#
```

Step 2 Set the encryption method. The following example configures 3DES.

```
hostname(config)# isakmp policy 1 encryption 3des
hostname(config)#
```

Step 3 Set the HMAC method. The following example configures SHA-1.

```
hostname(config)# isakmp policy 1 hash sha
hostname(config)#
```

Step 4 Set the Diffie-Hellman group. The following example configures Group 2.

```
hostname(config)# isakmp policy 1 group 2
hostname(config)#
```

Step 5 Set the encryption key lifetime. The following example configures 43,200 seconds (12 hours).

```
hostname(config)# isakmp policy 1 lifetime 43200
hostname(config)#
```

Step 6 Enable ISAKMP on the interface named outside.

```
hostname(config)# isakmp enable outside
hostname(config)#
```

Step 7 To save your changes, enter the **write memory** command.

```
hostname(config)# write memory
hostname(config)#
```

Configuring an Address Pool

The security appliance requires a method for assigning IP addresses to users. A common method is using address pools. The alternatives are having a DHCP server assign address or having an AAA server assign them. The following example uses an address pool.

Step 1 To configure an address pool, enter the **ip local pool** command. The syntax is **ip local pool poolname first_address-last_address**. In the following example the pool name is testpool.

```
hostname(config)# ip local pool testpool 192.168.0.10-192.168.0.15
hostname(config)#
```

Step 2 Save your changes.

```
hostname(config)# write memory
hostname(config)#
```

Adding a User

To identify remote access users to the security appliance, configure usernames and passwords.

Step 1 To add users, enter the **username** command. The syntax is **username username password password**. In the following example the username is testuser and the password is 12345678.

```
hostname(config)# username testuser password 12345678
hostname(config)#
```

Step 2 Repeat Step 1 for each additional user.

Creating a Transform Set

A transform set combines an encryption method and an authentication method. During the IPsec security association negotiation with ISAKMP, the peers agree to use a particular transform set to protect a particular data flow. The transform set must be the same for both peers.

You can create multiple transform sets, and then specify one or more of these transform sets in a crypto map entry. The security appliance uses the transform set to protect the data flows for that crypto map entry access list. For more overview information, including a table that lists valid encryption and authentication methods, see [Creating a Transform Set](#) in Chapter 28, “Configuring LAN-to-LAN VPNs” of this guide.

Step 1 To configure a transform set, in global configuration mode enter the **crypto ipsec transform-set** command. The syntax is:

```
crypto ipsec transform-set transform-set-name encryption-method authentication-method
```

The following example configures a transform set with the name FirstSet, esp-3des encryption, and esp-md5-hmac authentication:

```
hostname(config)# crypto ipsec transform set FirstSet esp-3des esp-md5-hmac
hostname(config)#
```

Step 2 Save the changes.

```
hostname(config)# write memory
hostname(config)#
```

Defining a Tunnel Group

A tunnel group is a set of records that contain tunnel connection policies. You configure a tunnel group to identify AAA servers, specify connection parameters, and define a default group policy. The security appliance stores tunnel groups internally.

There are two default tunnel groups in the security appliance system: DefaultRAGroup, which is the default IPsec remote-access tunnel group, and DefaultL2Lgroup, which is the default IPsec LAN-to-LAN tunnel group. You can change them but not delete them. The security appliance uses these groups to configure default tunnel parameters for remote access and LAN-to-LAN tunnel groups when there is no specific tunnel group identified during tunnel negotiation.

To establish a basic remote access connection, you must set three attributes for a tunnel group:

- Set the connection type to IPsec remote access.
- Configure the address assignment method, in the following example, address pool.
- Configure an authentication method, in the following example, preshared key.

Step 1 To set the connection type to IPsec remote access, enter the **tunnel-group** command. The command syntax is **tunnel-group name type type**, where *name* is the name you assign to the tunnel group, and *type* is the type of tunnel. The tunnel types as you enter them in the CLI include the following:

- ipsec-ra (IPsec remote access)
- ipsec-l2l (IPsec LAN to LAN)

In the following example the name of the tunnel group is testgroup.

```
hostname(config)# tunnel-group testgroup type ipsec-ra
hostname(config)#
```

Step 2 To configure an authentication method for the tunnel group, enter the general-attributes mode and then enter the **address-pool** command to create the address pool. In the following example the name of the group is testgroup and the name of the address pool is testpool.

```
hostname(config)# tunnel-group testgroup general-attributes
hostname(config-general)# address-pool testpool
```

- Step 3** To configure the authentication method, enter the ipsec-attributes mode and then enter the **pre-shared-key** command to create the preshared key. You need to use the same preshared key on both the security appliance and the client.

**Note**

The size of the preshared key must be no larger than the preshared key used by the VPN client. In the case of the Cisco VPN Client with a different preshared key size, when the client attempts to connect to a security appliance, the client logs an error message indicating it failed to authenticate the peer.

The key is an alphanumeric string of 1-128 characters. In the following example the preshared key is 44kkaol59636jnfx.

```
hostname(config)# tunnel-group testgroup ipsec-attributes
hostname(config-ipsec)# pre-shared-key 44kkaol59636jnfx
```

- Step 4** Save your changes.

```
hostname(config)# write memory
hostname(config)#
```

Creating a Dynamic Crypto Map

The security appliance uses dynamic crypto maps to define a policy template where all the parameters do not have to be configured. These dynamic crypto maps let the security appliance receive connections from peers without known IP addresses. Remote access clients fall in this category.

Dynamic crypto map entries identify the transform set for the connection. You also enable reverse routing, which lets the security appliance learn routing information for connected clients, and advertise it via RIP or OSPF.

- Step 1** To specify a transform set for a dynamic crypto map entry, enter the **crypto dynamic-map set transform-set** command.

The syntax is **crypto dynamic -map** *dynamic-map-name seq-num set transform-set transform-set-name*. In the following example the name of the dynamic map is dyn1, the sequence number is 1, and the transform set name is FirstSet.

```
hostname(config)# crypto dynamic-map dyn1 1 set transform-set FirstSet
hostname(config)#
```

- Step 2** To enable RRI for any connection based on this crypto map entry, enter the **crypto dynamic-map set reverse route** command.

```
hostname(config)# crypto dynamic-map dyn1 1 set reverse-route
hostname(config)#
```

- Step 3** Save your changes.

```
hostname(config)# write memory
hostname(config)#
```

Creating a Crypto Map Entry to Use the Dynamic Crypto Map

Next create a crypto map entry that lets the security appliance use the dynamic crypto map to set the parameters of IPSec security associations.

In the following examples for this command, the name of the crypto map is `mymap`, the sequence number is 1, and the name of the dynamic crypto map is `dyn1`, which you created in the previous section, [Creating a Dynamic Crypto Map](#). Enter these commands in global configuration mode.

-
- Step 1** To create a crypto map entry that uses a dynamic crypto map, enter the **crypto map** command. The syntax is **crypto map** *map-name* *seq-num* **ipsec-isakmp** **dynamic** *dynamic-map-name*.

```
hostname(config)# crypto map mymap 1 ipsec-isakmp dynamic dyn1
hostname(config)#
```

- Step 2** To apply the crypto map to the outside interface, enter the **crypto map interface** command.

The syntax is **crypto map** *map-name* **interface** *interface-name*

```
hostname(config)# crypto map mymap interface outside
hostname(config)#
```

■ Creating a Crypto Map Entry to Use the Dynamic Crypto Map



Configuring LAN-to-LAN VPNs

A LAN-to-LAN VPN connects networks in different geographic locations.



Note

The ASA supports LAN-to-LAN IPsec connections with Cisco peers, and with third-party peers that comply with all relevant standards.

This chapter describes how to build a LAN-to-LAN VPN connection. It includes the following sections:

- [Summary of the Configuration, page 28-1](#)
- [Configuring Interfaces, page 28-2](#)
- [Configuring ISAKMP Policy and Enabling ISAKMP on the Outside Interface, page 28-2](#)
- [Creating a Transform Set, page 28-4](#)
- [Configuring an ACL, page 28-4](#)
- [Defining a Tunnel Group, page 28-5](#)
- [Creating a Crypto Map and Applying It To an Interface, page 28-6](#)

Summary of the Configuration

This section provides a summary of the example LAN-to-LAN configuration this chapter creates. Later sections provide step-by-step instructions.

```
hostname(config)# interface ethernet0
hostname(config-if)# ip address 10.10.4.100 255.255.0.0
hostname(config-if)# no shutdown
hostname(config)# isakmp policy 1 authentication pre-share
hostname(config)# isakmp policy 1 encryption 3des
hostname(config)# isakmp policy 1 hash sha
hostname(config)# isakmp policy 1 group 2
hostname(config)# isakmp policy 1 lifetime 43200
hostname(config)# isakmp enable outside
hostname(config)# crypto ipsec transform set FirstSet esp-3des esp-md5-hmac
hostname(config)# access-list 121_list extended permit ip 192.168.0.0 255.255.0.0
150.150.0.0 255.255.0.0
hostname(config)# tunnel-group 10.10.4.108 type ipsec-l2l
hostname(config)# tunnel-group 10.10.4.108 ipsec-attributes
hostname(config-ipsec)# pre-shared-key 44kkaol59636jfnfx
hostname(config)# crypto map abcmap 1 match address 121_list
hostname(config)# crypto map abcmap 1 set peer 10.10.4.108
hostname(config)# crypto map abcmap 1 set transform-set FirstSet
```

```
hostname(config)# crypto map abcmap interface outside
hostname(config)# write memory
```

Configuring Interfaces

A security appliance has at least two interfaces, referred to here as outside and inside. Typically, the outside interface is connected to the public Internet, while the inside interface is connected to a private network and is protected from public access.

To begin, configure and enable two interfaces on the security appliance. Then, assign a name, IP address and subnet mask. Optionally, configure its security level, speed, and duplex operation on the security appliance.

To configure interfaces, perform the following steps, using the command syntax in the examples:

-
- Step 1** To enter Interface configuration mode, in global configuration mode enter the **interface** command with the default name of the interface to configure. In the following example the interface is ethernet0.

```
hostname(config)# interface ethernet0
hostname(config-if)#
```

- Step 2** To set the IP address and subnet mask for the interface, enter the **ip address** command. In the following example the IP address is 10.10.4.100 and the subnet mask is 255.255.0.0.

```
hostname(config-if)# ip address 10.10.4.100 255.255.0.0
hostname(config-if)#
```

- Step 3** To name the interface, enter the **nameif** command, maximum of 48 characters. You cannot change this name after you set it. In the following example the name of the ethernet0 interface is outside.

```
hostname(config-if)# nameif outside
hostname(config-if)##
```

- Step 4** To enable the interface, enter the **no** version of the **shutdown** command. By default, interfaces are disabled.

```
hostname(config-if)# no shutdown
hostname(config-if)#
```

- Step 5** To save your changes, enter the **write memory** command.

```
hostname(config-if)# write memory
hostname(config-if)#
```

- Step 6** To configure a second interface, use the same procedure.
-

Configuring ISAKMP Policy and Enabling ISAKMP on the Outside Interface

The Internet Security Association and Key Management Protocol, also called IKE, is the negotiation protocol that lets two hosts agree on how to build an IPsec security association. Each ISAKMP negotiation is divided into two sections called Phase1 and Phase 2.

Phase 1 creates the first tunnel, which protects later ISAKMP negotiation messages. Phase 2 creates the tunnel that protects data travelling across the secure connection.

To set the terms of the ISAKMP negotiations, you create an ISAKMP policy, which includes the following:

- An authentication method, to ensure the identity of the peers.
- An encryption method, to protect the data and ensure privacy.
- A Hashed Message Authentication Codes method to ensure the identity of the sender and to ensure that the message has not been modified in transit.
- A Diffie-Hellman group to establish the strength of the encryption-key-determination algorithm. The security appliance uses this algorithm to derive the encryption and hash keys.
- A time limit for how long the security appliance uses an encryption key before replacing it.

See [on page 23-3](#) in the “Configuring IPsec and ISAKMP” chapter of this guide for detailed information about the IKE policy keywords and their values.

To configure ISAKMP policies, in global configuration mode use the **isakmp policy** command with its various arguments. The syntax for ISAKMP policy commands is as follows:

```
isakmp policy priority attribute_name [attribute_value | integer].
```

Perform the following steps and use the command syntax in the following examples as a guide.

Step 1 Set the authentication method. The following example configures a preshared key. The priority is 1 in this and all following steps.

```
hostname(config)# isakmp policy 1 authentication pre-share  
hostname(config)#
```

Step 2 Set the encryption method. The following example configures 3DES.

```
hostname(config)# isakmp policy 1 encryption 3des  
hostname(config)#
```

Step 3 Set the HMAC method. The following example configures SHA-1.

```
hostname(config)# isakmp policy 1 hash sha  
hostname(config)#
```

Step 4 Set the Diffie-Hellman group. The following example configures Group 2.

```
hostname(config)# isakmp policy 1 group 2  
hostname(config)#
```

Step 5 Set the encryption key lifetime. The following example configures 43,200 seconds (12 hours).

```
hostname(config)# isakmp policy 1 lifetime 43200  
hostname(config)#
```

Step 6 Enable ISAKMP on the interface named outside.

```
hostname(config)# isakmp enable outside  
hostname(config)#
```

Step 7 To save your changes, enter the **write memory** command.

```
hostname(config)# write memory  
hostname(config)#
```

Creating a Transform Set

A transform set combines an encryption method and an authentication method. During the IPsec security association negotiation with ISAKMP, the peers agree to use a particular transform set to protect a particular data flow. The transform set must be the same for both peers.

You can create multiple transform sets, and then specify one or more of these transform sets in a crypto map entry. The security appliance uses the transform set to protect the data flows for that crypto map entry access list.

Table 28-1 lists valid encryption and authentication methods.

Table 28-1 Encryption and Authentication Methods

Valid Encryption Methods	Valid Authentication Methods
esp-des	esp-md5-hmac
esp-3des (default)	esp-sha-hmac (default)
esp-aes (128-bit encryption)	
esp-aes-192	
esp-aes-256	
esp-null	

Tunnel Mode is the usual way to implement IPsec between two security appliances that are connected over an untrusted network, such as the public Internet. Tunnel mode is the default and requires no configuration.

To configure a transform set, perform the following steps:

-
- Step 1** In global configuration mode enter the **crypto ipsec transform-set** command. The following example configures a transform set with the name FirstSet, esp-3des encryption, and esp-md5-hmac authentication. The syntax is as follows:

crypto ipsec transform-set *transform-set-name encryption-method authentication-method*

```
hostname(config)# crypto ipsec transform-set FirstSet esp-3des esp-md5-hmac
hostname(config)#
```

- Step 2** Save your changes.

```
hostname(config)# write memory
hostname(config)#
```

Configuring an ACL

The security appliance uses access control lists to control network access. By default, the security appliance denies all traffic. You need to configure an ACL that permits traffic.

The ACLs that you configure for this LAN-to-LAN VPN control connections are based on the source and destination IP addresses. Configure ACLs that mirror each other on both sides of the connection.

To configure an ACL, perform the following steps:

- Step 1** Enter the **access-list extended** command. The following example configures an ACL named `l2l_list` that lets traffic from IP addresses in the 192.168.0.0 network travel to the 150.150.0.0 network. The syntax is **access-list listname extended permit ip source-ipaddress source-netmask destination-ipaddress destination-netmask**.

```
hostname(config)# access-list l2l_list extended permit ip 192.168.0.0 255.255.0.0
150.150.0.0 255.255.0.0
hostname(config)#
```

- Step 2** Configure an ACL for the security appliance on the other side of the connection that mirrors the ACL above. In the following example the prompt for the peer is `hostname2`.

```
hostname2(config)# access-list l2l_list extended permit ip 150.150.0.0 255.255.0.0
192.168.0.0 255.255.0.0
hostname2(config)#
```

Defining a Tunnel Group

A tunnel group is a set of records that contain tunnel connection policies. You configure a tunnel group to identify AAA servers, specify connection parameters, and define a default group policy. The security appliance stores tunnel groups internally.

There are two default tunnel groups in the security appliance system: `DefaultRAGroup`, which is the default IPsec remote-access tunnel group, and `DefaultL2Lgroup`, which is the default IPsec LAN-to-LAN tunnel group. You can modify them but not delete them. You can also create one or more new tunnel groups to suit your environment. The security appliance uses these groups to configure default tunnel parameters for remote access and LAN-to-LAN tunnel groups when there is no specific tunnel group identified during tunnel negotiation.

To establish a basic LAN-to-LAN connection, you must set two attributes for a tunnel group:

- Set the connection type to IPsec LAN-to-LAN.
- Configure an authentication method, in the following example, preshared key.

- Step 1** To set the connection type to IPsec LAN-to-LAN, enter the **tunnel-group** command. The syntax is **tunnel-group name type type**, where *name* is the name you assign to the tunnel group, and *type* is the type of tunnel. The tunnel types as you enter them in the CLI are:

- **ipsec-ra** (IPsec remote access)
- **ipsec-l2l** (IPsec LAN to LAN)

In the following example the name of the tunnel group is the IP address of the LAN-to-LAN peer, 10.10.4.108.

```
hostname(config)# tunnel-group 10.10.4.108 type ipsec-l2l
hostname(config)#
```

Step 2 To set the authentication method to preshared key, enter the `ipsec-attributes` mode and then enter the **pre-shared-key** command to create the preshared key. You need to use the same preshared key on both security appliances for this LAN-to-LAN connection.

The key is an alphanumeric string of 1-128 characters. In the following example the preshared key is `44kkaol59636jnfX`.

```
hostname(config)# tunnel-group 10.10.4.108 ipsec-attributes
hostname(config-ipsec)# pre-shared-key 44kkaol59636jnfX
```

Step 3 Save your changes.

```
hostname(config)# write memory
hostname(config)#
```

Creating a Crypto Map and Applying It To an Interface

Crypto map entries pull together the various elements of IPsec security associations, including the following:

- Which traffic IPsec should protect, which you define in an access list.
- Where to send IPsec-protected traffic, by identifying the peer.
- What IPsec security applies to this traffic, which a transform set specifies.
- The local address for IPsec traffic, which you identify by applying the crypto map to an interface.

For IPsec to succeed, both peers must have crypto map entries with compatible configurations. For two crypto map entries to be compatible, they must, at a minimum, meet the following criteria:

- The crypto map entries must contain compatible crypto access lists (for example, mirror image access lists). If the responding peer uses dynamic crypto maps, the entries in the security appliance crypto access list must be “permitted” by the peer’s crypto access list.
- The crypto map entries each must identify the other peer (unless the responding peer is using a dynamic crypto map).
- The crypto map entries must have at least one transform set in common.

If you create more than one crypto map entry for a given interface, use the sequence number (`seq-num`) of each entry to rank it: the lower the `seq-num`, the higher the priority. At the interface that has the crypto map set, the security appliance evaluates traffic against the entries of higher priority maps first.

Create multiple crypto map entries for a given interface if either of the following conditions exist:

- Different peers handle different data flows.
- You want to apply different IPsec security to different types of traffic (to the same or separate peers), for example, if you want traffic between one set of subnets to be authenticated, and traffic between another set of subnets to be both authenticated and encrypted. In this case, define the different types of traffic in two separate access lists, and create a separate crypto map entry for each crypto access list.

To create a crypto map and apply it to the outside interface in global configuration mode, enter several of the **crypto map** commands. These commands use a variety of arguments, but the syntax for all of them begin with **crypto map** *map-name-seq-num*. In the following example the map-name is `abcmap`, the sequence number is 1.

Enter these commands in global configuration mode:

-
- Step 1** To assign an access list to a crypto map entry, enter the **crypto map match address** command.
- The syntax is **crypto map map-name seq-num match address aclname**. In the following example the map name is `abcmap`, the sequence number is `1`, and the access list name is `121_list`.
- ```
hostname(config)# crypto map abcmap 1 match address 121_list
hostname(config)#
```
- Step 2** To identify the peer (s) for the IPsec connection, enter the **crypto map set peer** command.
- The syntax is **crypto map map-name seq-num set peer {ip\_address1 | hostname1}[... ip\_address10 | hostname10]**. In the following example the peer name is `10.10.4.108`.
- ```
hostname(config)# crypto map abcmap 1 set peer 10.10.4.108
hostname(config)#
```
- Step 3** To specify a transform set for a crypto map entry, enter the **crypto map set transform-set** command.
- The syntax is **crypto map map-name seq-num set transform-set transform-set-name**. In the following example the transform set name is `FirstSet`.
- ```
hostname(config)# crypto map abcmap 1 set transform-set FirstSet
hostname(config)#
```
- 

## Applying Crypto Maps to Interfaces

You must apply a crypto map set to each interface through which IPsec traffic travels. The security appliance supports IPsec on all interfaces. Applying the crypto map set to an interface instructs the security appliance to evaluate all interface traffic against the crypto map set and to use the specified policy during connection or security association negotiations.

Binding a crypto map to an interface also initializes the runtime data structures, such as the security association database and the security policy database. When you later modify a crypto map in any way, the security appliance automatically applies the changes to the running configuration. It drops any existing connections and reestablishes them after applying the new crypto map.

- 
- Step 1** To apply the configured crypto map to the outside interface, enter the **crypto map interface** command. The syntax is **crypto map map-name interface interface-name**.
- ```
hostname(config)# crypto map abcmap interface outside
hostname(config)#
```
- Step 2** Save your changes.
- ```
hostname(config)# write memory
hostname(config)#
```
-





## Configuring WebVPN

---

This chapter describes WebVPN. WebVPN lets users establish a secure, remote-access VPN tunnel to a security appliance using a web browser. There is no need for either a software or hardware client. WebVPN provides easy access to a broad range of web resources and web-enabled applications from almost any computer on the Internet. These include secure access to the following resources:

- Internal websites
- Web-enabled applications
- NT/Active Directory file shares
- Email proxies, including POP3S, IMAP4S, and SMTPS
- MS Outlook Web Access
- MAPI
- Port forwarding for access to other TCP-based applications.

WebVPN uses Secure Sockets Layer Protocol and its successor, Transport Layer Security to provide a secure connection between remote users and specific, supported internal resources that you configure at a central site. The security appliance recognizes connections that need to be proxied, and the HTTP server interacts with the authentication subsystem to authenticate users.

The network administrator provides access to WebVPN resources to users on a group basis. Users have no direct access to resources on the internal network.

This chapter includes the following sections:

- [Observing WebVPN Security Precautions](#)
- [Understanding Features Not Supported for WebVPN](#)
- [Using SSL to Access the Central Site](#)
- [Authenticating with Digital Certificates](#)
- [Enabling Cookies on Browsers for WebVPN](#)
- [Understanding WebVPN Global and Group Policy Settings](#)
- [Configuring Global WebVPN Attributes](#)
- [Creating Port Forwarding, URL, and Access Lists in Global Configuration Mode](#)
- [Enabling Features for Group Policies and Users](#)
- [Configuring Email](#)
- [Understanding WebVPN End User Set-up](#)
- [Recovering from hosts File Errors in Application Access](#)

- [Capturing WebVPN Data](#)

## Observing WebVPN Security Precautions

WebVPN connections on the security appliance are very different from remote access IPSec connections, particularly with respect to how they interact with SSL-enabled servers, and precautions to reduce security risks.

In a WebVPN connection, the security appliance acts as a proxy between the end user web browser and target web servers. When a WebVPN user connects to an SSL-enabled web server, the security appliance establishes a secure connection and validates the server SSL certificate. The end user browser never receives the presented certificate, so therefore cannot examine and validate the certificate.

The current implementation of WebVPN on the security appliance does not permit communication with sites that present expired certificates. Nor does the security appliance perform trusted CA certificate validation. Therefore, WebVPN users cannot analyze the certificate an SSL-enabled web-server presents before communicating with it.

To minimize the risks involved with SSL certificates:

1. Configure a group policy that consists of all users who need WebVPN access and enable the WebVPN feature only for that group policy.
2. Limit Internet access for WebVPN users. One way to do this is to disable URL entry. Then configure links to specific targets within the private network that you want WebVPN users to be able to access.
3. Educate users. If an SSL-enabled site is not inside the private network, users should not visit this site over a WebVPN connection. They should open a separate browser window to visit such sites, and use that browser to view the presented certificate.

## Understanding Features Not Supported for WebVPN

The security appliance does not support the following features for WebVPN connections:

- Active/Active or Active/Standby Stateful Failover, letting you configure two security appliances so that one takes over operation if the first one fails.
- Inspection features under the Modular Policy Framework, inspecting configuration control.
- Functionality the filter configuration commands provide, including the **vpn-filter** command.
- NAT, reducing the need for globally unique IP addresses.
- PAT, permitting multiple outbound sessions appear to originate from a single IP address.
- QoS, rate limiting using the **police** command and **priority-queue** command.
- Connection limits, checking either via the static or the Modular Policy Framework **set connection** command.
- The **established** command, allowing return connections from a lower security host to a higher security host if there is already an established connection from the higher level host to the lower level host.

# Using SSL to Access the Central Site

WebVPN uses SSL and its successor, TLS1 to provide a secure connection between remote users and specific, supported internal resources at a central site. This section includes the following topics:

- [Using HTTPS for WebVPN Sessions](#)
- [Setting WebVPN HTTP/HTTPS Proxy](#)
- [Configuring SSL/TLS Encryption Protocols](#)

## Using HTTPS for WebVPN Sessions

Establishing WebVPN sessions requires the following:

- Using HTTPS to access the security appliance or load balancing cluster. In a web browser, users enter the security appliance IP address in the format `https:// address` where *address* is the IP address or DNS hostname of the security appliance interface.
- Enabling WebVPN sessions on the security appliance interface that users connect to.

To permit WebVPN sessions on an interface, perform the following steps:

- 
- Step 1** In global configuration mode, enter the **webvpn** command to enter webvpn mode.
- Step 2** Enter the **enable** command with the name of the interface that you want to use for WebVPN sessions. For example, to enable WebVPN sessions on the interface called `outside`, enter the following:

```
hostname(config)# webvpn
hostname(config-webvpn)# enable outside
```

---

**Note**

ASA supports either WebVPN or an ASDM administrative session on an interface, but not both simultaneously. To use ASDM and WebVPN at the same time, configure them on different interfaces.

---

## Setting WebVPN HTTP/HTTPS Proxy

The security appliance can terminate HTTPS connections and forward HTTP/HTTPS requests to HTTP and HTTPS proxy servers. These servers act as intermediaries between users and the Internet. Requiring all Internet access via a server that the organization controls provides another opportunity for filtering to assure secure Internet access and administrative control.

To set values for HTTP and HTTPS proxy, enter the **http-proxy** and **https-proxy** commands in webvpn mode.

## Configuring SSL/TLS Encryption Protocols

When you set SSL/TLS encryption protocols, be aware of the following:

- Make sure that the security appliance and the browser you use allow the same SSL/TLS encryption protocols.
- If you configure email proxy, do not set the security appliance SSL version to TLSv1 Only. MS Outlook and MS Outlook Express do not support TLS.
- TCP Port Forwarding requires Sun Microsystems Java Runtime Environment (JRE) version 1.4.x and 1.5.x. Port forwarding does not work when a WebVPN user connects with some SSL versions, as follows:
 

|                         |                          |
|-------------------------|--------------------------|
| • Negotiate SSLv3       | • Java downloads         |
| • Negotiate SSLv3/TLSv1 | • Java downloads         |
| • Negotiate TLSv1       | • Java does NOT download |
| • TLSv1Only             | • Java does NOT download |
| • SSLv3Only             | • Java does NOT download |

## Authenticating with Digital Certificates

SSL uses digital certificates for authentication. The security appliance creates a self-signed SSL server certificate when it boots; or you can install in the security appliance an SSL certificate that has been issued in a PKI context. For HTTPS, this certificate must then be installed on the client. You need to install the certificate from a given security appliance only once.

Restrictions for authenticating users with digital certificates include the following:

- Port forwarding does not work for WebVPN users who authenticate using digital certificates. JRE does not have the ability to access the web browser keystore. Therefore JAVA cannot use a certificate that the browser uses to authenticate a user, so it cannot start.
- Email proxy supports certificate authentication with Netscape 7.x email clients only. Other email clients such as MS Outlook, MS Outlook Express, and Eudora lack the ability to access the certificate store.

## Enabling Cookies on Browsers for WebVPN

Browser cookies are required for the proper operation of WebVPN. When cookies are disabled on the web browser, the links from the web portal home page open a new window prompting the user to log in once more.



# Understanding WebVPN Global and Group Policy Settings

In general, the tunnel group and group policy commands for IPsec sessions do not apply for WebVPN. For WebVPN, use these same commands in global webvpn mode. The exceptions to this are:

- WebVPN commands from the group policy WebVPN mode apply.
- The banner, if any, that the client applies to WebVPN sessions.
- The **vpn-idletimeout**, **vpn-tunnel-protocol**, and **vpn-session-timeout** commands apply.

Web VPN uses authentication, authorization, and accounting settings specific to WebVPN, which you configure with the global webvpn commands. [Table 29-1](#) lists the commands specific to WebVPN for these features:

**Table 29-1** Commands Specific to WebVPN

| Command                                         |
|-------------------------------------------------|
| <b>accounting-server-group</b>                  |
| <b>authentication-server-group</b> <sup>1</sup> |
| <b>authorization-server-group</b>               |
| <b>authorization-dn-attributes</b>              |
| <b>authorization-required</b>                   |

1. In Version 7.0.x, WebVPN does not support RADIUS with Expiry authentication.

## Authenticating with Digital Certificates

WebVPN users that authenticate using digital certificates do not use global authentication and authorization settings. Instead, they use an authorization server to authenticate once the certificate validation occurs.

## Configuring DNS Globally

WebVPN does not use the DNS settings of the group policy with which it has connected. WebVPN follows the security appliance global DNS settings. Ensure that the global DNS settings of the security appliance are configured properly.

## Configuring Global WebVPN Attributes

[Table 29-2](#) lists WebVPN attributes that apply globally to WebVPN users:

**Table 29-2** Global WebVPN Attributes

| Function                                                                   | Command                        | Default Value |
|----------------------------------------------------------------------------|--------------------------------|---------------|
| Specifies the previously configured accounting servers to use with WebVPN. | <b>accounting-server-group</b> | None          |
| Specifies the authentication method(s) for WebVPN users.                   | <b>authentication</b>          | AAA           |

Table 29-2 Global WebVPN Attributes (continued)

| Function                                                                                   | Command                            | Default Value                                    |
|--------------------------------------------------------------------------------------------|------------------------------------|--------------------------------------------------|
| Specifies the previously configured authentication servers to use with WebVPN.             | <b>authentication-server-group</b> | LOCAL                                            |
| Specifies the previously configured authorization servers to use with WebVPN.              | <b>authorization-server-group</b>  | None                                             |
| Requires users to authorize successfully to connect.                                       | <b>authorization-required</b>      | Disabled                                         |
| Identifies the DN of the peer certificate to use as a username for authorization.          | <b>authorization-dn-attributes</b> | Primary attribute: CN<br>Secondary attribute: OU |
| Specifies the name of the group policy to use.                                             | <b>default-group-policy</b>        | DfltGrpPolicy                                    |
| Specifies the default idle timeout (in seconds).                                           | <b>default-idle-timeout</b>        | 1800 seconds (30 minutes)                        |
| Enables WebVPN on the specified interface.                                                 | <b>enable</b>                      | Disabled                                         |
| Identifies the proxy server for HTTP requests.                                             | <b>http-proxy</b>                  | None                                             |
| Identifies the proxy server for HTTPS requests.                                            | <b>https-proxy</b>                 | None                                             |
| Configures the HTML text that prompts a user to log in.                                    | <b>login-message</b>               | “Please enter your username and password.”       |
| Specifies the logo image that displays on the WebVPN login and home pages.                 | <b>logo</b>                        | Cisco logo                                       |
| Configures the HTML text the security appliance presents to a user logging out.            | <b>logout-message</b>              | “Goodbye.”                                       |
| Identifies the NetBIOS Name Service server for CIFS name resolution.                       | <b>nbns-server</b>                 | None                                             |
| Configures the prompt for a username at initial login to WebVPN.                           | <b>username-prompt</b>             | “Login:”                                         |
| Configures the prompt for the password at initial login to WebVPN.                         | <b>password-prompt</b>             | “Password:”                                      |
| Configures the HTML title string that is in the WebVPN browser title and on the title bar. | <b>title</b>                       | “WebVPN Service”                                 |
| Configures the color of the title bars on the login, home and file access pages.           | <b>title-color</b>                 | HTML #999CC, a lavender color                    |
| Configures the color of the text bars on the login, home, and file access pages.           | <b>text-color</b>                  | White                                            |
| Configures the color of the secondary title bars on the login, home and file access pages. | <b>secondary-color</b>             | HTML #CCCCFF, a lavender color                   |
| Configures the color of the secondary text bars on the login, home and file access pages.  | <b>secondary-text-color</b>        | Black                                            |

You enter these WebVPN commands in `webvpn` mode. To enter `webvpn` mode, in global configuration mode, enter the **webvpn** command.

To reset all commands entered with the **webvpn** command to default values, use the **no webvpn** command.

# Creating and Applying WebVPN Policies

Creating and applying WebVPN policies that govern access to resources at the central site includes the following tasks:

- [Creating Port Forwarding, URL, and Access Lists in Global Configuration Mode](#)
- [Assigning Lists to Group Policies and Users in Group-Policy or User Mode](#)
- [Enabling Features for Group Policies and Users](#)
- [Assigning Users to Group Policies](#)

## Creating Port Forwarding, URL, and Access Lists in Global Configuration Mode

Use the **port forward**, **url-list**, and **access-list** commands in global configuration mode to configure the lists of ports to forward and URLs to present to WebVPN users, and their level of access.

## Assigning Lists to Group Policies and Users in Group-Policy or User Mode

After you configure port forwarding and URL lists, use the **port forward** and **url-list**, and **filter** commands in **webvpn group-policy** or **user mode** to assign lists to group policies and/or users.

## Enabling Features for Group Policies and Users

To enable features for group policies and users, issue the **functions** command in **group-policy** or **user** configuration mode.

## Assigning Users to Group Policies

Assigning users to group policies simplifies configuration, by letting you apply policies to many users, rather than configuring policies for each user individually. There are two ways to assign users to group policies:

### Using a RADIUS Server

Using a RADIUS server to authenticate users, assign users to group policies by following these steps:

- 
- Step 1** Authenticate the user with RADIUS and use the Class attribute to assign that user to a particular group policy.
- Step 2** Set the class attribute to the group policy name in the format `OU=group_name`
- For example, to set a WebVPN user to the `SSL_VPN` group, set the RADIUS Class Attribute to a value of `OU=SSL_VPN`; (Do not omit the semicolon.)
-

## Using the Security Appliance Authentication Server

You can also configure users to authenticate to the security appliance internal authentication server, and assign these users to a group policy on the security appliance.

# Configuring WebVPN Group Policy and User Attributes

Table 29-3 lists all WebVPN group policy and user attributes:

**Table 29-3** WebVPN Group Policy Attributes

| Function                                                                                                                      | Command                    | Default Value                                                                            |
|-------------------------------------------------------------------------------------------------------------------------------|----------------------------|------------------------------------------------------------------------------------------|
| Configures the name of the weertype access list.                                                                              | <b>filter</b>              | The security appliance does not enforce WebVPN access lists until you enter this command |
| Enables some or all of these WebVPN features: file access, file browsing, file entry, URL entry, port forwarding, MAPI proxy. | <b>functions</b>           | Disabled                                                                                 |
| Sets the URL of the web page that displays upon login.                                                                        | <b>homepage</b>            | None                                                                                     |
| Configures the content and objects to filter from the HTML for this group policy.                                             | <b>html-content-filter</b> | No filtering                                                                             |
| Applies a list of WebVPN TCP ports to forward. The user interface displays the applications on this list.                     | <b>port-forward</b>        | None                                                                                     |
| Configures the name of the port forwarding applet.                                                                            | <b>port-forward-name</b>   | “Application Access”                                                                     |
| Applies a list of WebVPN servers and URLs that the user interface displays for end user access.                               | <b>url-list</b>            | None                                                                                     |

## Configuring Email

WebVPN supports several ways to access email. This section includes the following methods:

- [Configuring Email Proxies](#)
- [Configuring MAPI](#)
- [Configuring Web Email: MS Outlook Web Access](#)

## Configuring Email Proxies

WebVPN supports IMAP4S, POP3S, and SMTPS email proxies. Table 29-4 lists attributes that apply globally to Email proxy users:

**Table 29-4 Global Email proxy Attributes**

| Function                                                                            | Command                            | Default Value                                                          |
|-------------------------------------------------------------------------------------|------------------------------------|------------------------------------------------------------------------|
| Specifies the previously configured accounting servers to use with Email proxy.     | <b>accounting-server-group</b>     | None                                                                   |
| Specifies the authentication method(s) for Email proxy users.                       | <b>authentication</b>              | IMAP4S: Mailhost (required)<br>POP3S Mailhost (required)<br>SMTPS: AAA |
| Specifies the previously configured authentication servers to use with Email proxy. | <b>authentication-server-group</b> | LOCAL                                                                  |
| Specifies the previously configured authorization servers to use with WebVPN.       | <b>authorization-server-group</b>  | None                                                                   |
| Requires users to authorize successfully to connect.                                | <b>authorization-required</b>      | Disabled                                                               |
| Identifies the DN of the peer certificate to use as a username for authorization.   | <b>authorization-dn-attributes</b> | Primary attribute: CN<br>Secondary attribute: OU                       |
| Specifies the name of the group policy to use.                                      | <b>default-group-policy</b>        | DfltGrpPolicy                                                          |
| Enables Email proxy on the specified interface.                                     | <b>enable</b>                      | Disabled                                                               |
| Defines the separator between the email and VPN usernames and passwords.            | <b>name-separator</b>              | “:” (colon)                                                            |
| Configures the maximum number of outstanding non-authenticated sessions.            | <b>outstanding</b>                 | 20                                                                     |
| Sets the port the email proxy listens to.                                           | <b>port</b>                        | IMAP4S:993<br>POP3S: 995<br>SMTPS: 988 <sup>1</sup>                    |
| Specifies the default email server.                                                 | <b>server</b>                      | None.                                                                  |
| Defines the separator between the email and server names.                           | <b>server-separator</b>            | “@”                                                                    |

1. With the Eudora email client, SMTPS works only on port 465, even though the default port for SMTPS connections is 988.

### Email Proxy Certificate Authentication

Certificate authentication for email proxy connections works with Netscape 7x email clients. Other email clients such as MS Outlook, MS Outlook Express, and Eudora lack the ability to access the certificate store.

## Configuring MAPI

MAPI, also called MS Outlook Exchange proxy, has the following requirements:

- MS Outlook Exchange must be installed on the remote computer.
- You must enable MS Outlook Exchange Proxy on a security appliance interface. You do this by entering the **functions** command, which is a group-policy web vpn command. For example:

```
hostname(config)# group-policy group_policy_name attributes
hostname(config-group-policy)# webvpn
hostname(config-group-webvpn)# functions mapi
```

- Provide the Exchange server NetBIOS name. The Exchange server must be on the same domain as the security appliance DNS server. For example:

```
hostname(config)# domain domain_name
hostname(config)#
```



### Note

An open MS Outlook client connected via MS Outlook Exchange Mail Proxy is always checking for mail on the Exchange Server, which keeps the connection open. As long as Outlook is open, the connection never times out, regardless of the settings.

## Configuring Web Email: MS Outlook Web Access

Web email is MS Outlook Web Access for Exchange 2000, Exchange 5.5, and Exchange 2003. It requires an MS Outlook Exchange Server at the central site. It also requires that users perform the following tasks:

- Enter the URL of the mail server in a browser in your WebVPN session.
- When prompted, enter the email server username in the format *domain\username*.
- Enter the email password.

## Understanding WebVPN End User Set-up

This section is for the system administrator who sets up WebVPN for end users. It describes how to customize the end-user interface.

This section summarizes configuration requirements and tasks for a remote system. It specifies information to communicate to users to get them started using WebVPN. It includes the following topics:

- [Defining the End User Interface](#)
- [Requiring Usernames and Passwords](#)
- [Communicating Security Tips](#)
- [Configuring Remote Systems to Use WebVPN Features](#)

## Defining the End User Interface

The WebVPN end user interface is a series of html panels. A user logs on to WebVPN by entering the IP address of a security appliance interface in the format `https://address`. The first panel that displays is the login screen.

## Viewing the WebVPN Home Page

After the user logs in, the WebVPN home page displays (Figure 29-1).

Figure 29-1 WebVPN Home Page

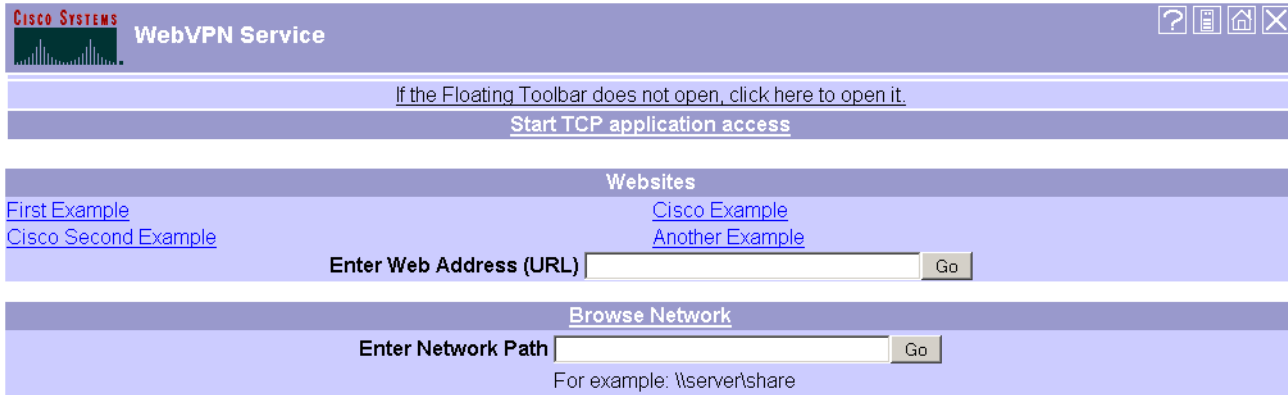

132244

The home page displays all of the WebVPN features you have configured, and its appearance reflects the logo, text, and colors you have selected. This sample home page includes all available WebVPN features with the exception of identifying specific file shares. It lets users browse the network, enter URLs, access specific websites, and use port forwarding to access TCP applications.

## Viewing the WebVPN Application Access Panel

To start port forwarding, also called application access, a user clicks the “Start TCP application access” link. The Application Access Panel opens (Figure 29-2).

Figure 29-2 WebVPN Application Access Panel

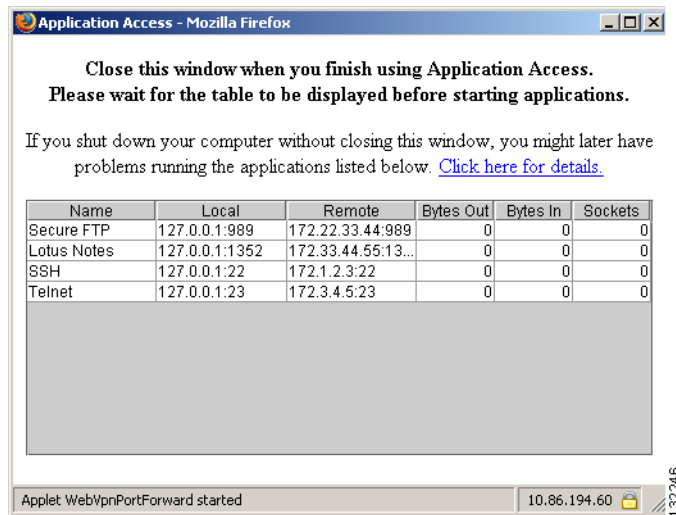

132246

This panel displays the TCP applications configured for this WebVPN connection. To use an application, with this panel open, the user starts the application in the normal way.

## Viewing the Floating Toolbar

WebVPN also includes a floating toolbar (Figure 29-3).

**Figure 29-3** WebVPN Floating Toolbar

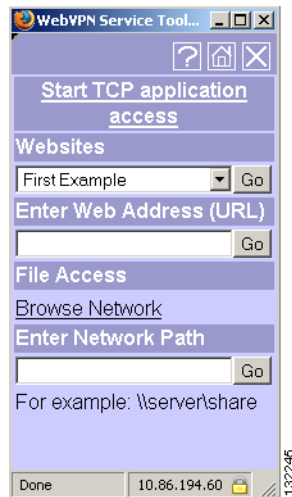

Be aware of the following characteristics of the floating toolbar:

- The toolbar lets you enter URLs, browse file locations, and choose preconfigured web connections without interfering with the main browser window.
- If you configure your browser to block popups, the floating toolbar cannot display.
- The floating toolbar represents the current WebVPN session. If you click the **Close** button, the security appliance prompts you to confirm that you want to end the WebVPN session.

See [Table 29-6 on page 14](#) for detailed information about using WebVPN.

## Requiring Usernames and Passwords

Depending on your network, during a remote session users might have to log in to any or all of the following: the computer itself, an Internet service provider, WebVPN, mail or file servers, or corporate applications. Users might have to authenticate in many different contexts, requiring different information, such as a unique username, password, or pincode.

[Table 29-5](#) lists the type of usernames and passwords that WebVPN users might need to know.

**Table 29-5** Usernames and Passwords to Tell WebVPN Users

| Login Username/<br>Password Type | Purpose               | Entered When                               |
|----------------------------------|-----------------------|--------------------------------------------|
| Computer                         | Access the computer   | Starting the computer                      |
| Internet Service Provider        | Access the Internet   | Connecting to an Internet service provider |
| WebVPN                           | Access remote network | Starting WebVPN                            |



**Table 29-5** Usernames and Passwords to Tell WebVPN Users (continued)

| Login Username/<br>Password Type | Purpose                                   | Entered When                                                                  |
|----------------------------------|-------------------------------------------|-------------------------------------------------------------------------------|
| File Server                      | Access remote file server                 | Using the WebVPN file browsing feature to access a remote file server         |
| Corporate Application Login      | Access firewall-protected internal server | Using the WebVPN web browsing feature to access an internal protected website |
| Mail Server                      | Access remote mail server via WebVPN      | Sending or receiving email messages                                           |

## Communicating Security Tips

Advise users always to log out from the WebVPN session. (To log out of WebVPN, click the logout icon on the WebVPN toolbar or close the browser.)

Advise users that using WebVPN does not ensure that communication with every site is secure. WebVPN ensures the security of data transmission between the remote PC or workstation and the security appliance on the corporate network. If the user then accesses a non-HTTPS web resource (located on the Internet or on the internal network), the communication from the corporate security appliance to the destination web server is not secure.

## Configuring Remote Systems to Use WebVPN Features

[Table 29-6](#) includes information about setting up remote systems to use WebVPN. It includes the following tasks:

- Starting WebVPN
- Using the WebVPN Floating Toolbar
- Web Browsing
- Network Browsing and File Management
- Using Applications (Port Forwarding)
- Using Email via Port Forwarding
- Using Email via Web Access
- Using Email via email proxy

[Table 29-6](#) also provides information about the following:

- WebVPN requirements, by feature
- WebVPN supported applications
- Client application installation and configuration requirements
- Information you might need to provide end users
- Tips and use suggestions for end users

It is possible you have configured user accounts differently and that different WebVPN features are available to each user. We have organized the information in [Table 29-6](#) by feature, so you can skip over the information for unavailable features.

Table 29-6 WebVPN Remote System Configuration and End User Requirements

| Task                       | Remote System or End User Requirements                                                                              | Specifications or Use Suggestions                                                                                                                                                                                                                                                                                                                                                                                                                                                                                                                                                                                                                                 |
|----------------------------|---------------------------------------------------------------------------------------------------------------------|-------------------------------------------------------------------------------------------------------------------------------------------------------------------------------------------------------------------------------------------------------------------------------------------------------------------------------------------------------------------------------------------------------------------------------------------------------------------------------------------------------------------------------------------------------------------------------------------------------------------------------------------------------------------|
| Starting WebVPN            | A connection to the Internet                                                                                        | Any Internet connection is supported, including: <ul style="list-style-type: none"> <li>• Home DSL, cable, or dial-ups</li> <li>• Public kiosks</li> <li>• Hotel hook-ups</li> <li>• Airport wireless nodes</li> <li>• Internet cafes</li> </ul>                                                                                                                                                                                                                                                                                                                                                                                                                  |
|                            | A WebVPN-supported browser                                                                                          | We recommend the following browsers for WebVPN. Other browsers might not fully support WebVPN features.<br>On Microsoft Windows: <ul style="list-style-type: none"> <li>• Internet Explorer version 6.0</li> <li>• Netscape version 7.2</li> <li>• Mozilla version 1.7 and above</li> <li>• Firefox 1.x</li> </ul> On Linux: <ul style="list-style-type: none"> <li>• Mozilla version 1.7</li> <li>• Netscape version 7.2</li> <li>• Firefox 1.x</li> </ul> On Solaris: <ul style="list-style-type: none"> <li>• Netscape version 7.2</li> </ul> On Macintosh OS X: <ul style="list-style-type: none"> <li>• Safari version 1.0</li> <li>• Firefox 1.x</li> </ul> |
|                            | Cookies enabled on browser                                                                                          | Cookies must be enabled on the browser in order to access applications via port forwarding.                                                                                                                                                                                                                                                                                                                                                                                                                                                                                                                                                                       |
|                            | The URL for WebVPN                                                                                                  | An https address in the following form:<br><code>https://address</code><br>where <i>address</i> is the IP address or DNS hostname of an interface of the security appliance (or load balancing cluster) on which WebVPN is enabled. For example: <code>https://10.89.192.163</code> or <code>https://cisco.example.com</code> .                                                                                                                                                                                                                                                                                                                                   |
|                            | A WebVPN username and password                                                                                      |                                                                                                                                                                                                                                                                                                                                                                                                                                                                                                                                                                                                                                                                   |
| [Optional] A local printer | WebVPN does not support printing from a web browser to a network printer. Printing to a local printer is supported. |                                                                                                                                                                                                                                                                                                                                                                                                                                                                                                                                                                                                                                                                   |

Table 29-6 WebVPN Remote System Configuration and End User Requirements (continued)

| Task                              | Remote System or End User Requirements         | Specifications or Use Suggestions                                                                                                                                                                                                                                                                                                                                                                                                                                                                                                                                                                                                                                                                                                                                                                                                                                                                                                                                                          |
|-----------------------------------|------------------------------------------------|--------------------------------------------------------------------------------------------------------------------------------------------------------------------------------------------------------------------------------------------------------------------------------------------------------------------------------------------------------------------------------------------------------------------------------------------------------------------------------------------------------------------------------------------------------------------------------------------------------------------------------------------------------------------------------------------------------------------------------------------------------------------------------------------------------------------------------------------------------------------------------------------------------------------------------------------------------------------------------------------|
| Using the WebVPN Floating Toolbar |                                                | <p>A floating toolbar is available to simplify the use of WebVPN. The toolbar lets you enter URLs, browse file locations, and choose preconfigured web connections without interfering with the main browser window.</p> <p>If you configure your browser to block popups, the floating toolbar cannot display.</p> <p>The floating toolbar represents the current WebVPN session. If you click the <b>Close</b> button, the security appliance prompts you to confirm that you want to close the WebVPN session.</p> <p> <b>Tip</b> TIP: To paste text into a text field, use Ctrl-V. Right-clicking is disabled on the WebVPN toolbar.</p>                                                                                                                                                                                                                                                              |
| Web Browsing                      | Usernames and passwords for protected websites | <p>Using WebVPN does not ensure that communication with every site is secure. See the <a href="#">Communicating Security Tips</a> section.</p> <p>The look and feel of web browsing with WebVPN might be different from what users are accustomed to. For example, when using WebVPN:</p> <ul style="list-style-type: none"> <li>• The WebVPN title bar appears above each web page</li> <li>• You access websites by: <ul style="list-style-type: none"> <li>– Entering the URL in the Enter Web Address field on the WebVPN home page</li> <li>– Clicking on a preconfigured website link on the WebVPN home page</li> <li>– Clicking a link on a webpage accessed via one of the previous two methods</li> </ul> </li> </ul> <p>Also, depending on how you configured a particular account, it might be that:</p> <ul style="list-style-type: none"> <li>• Some websites are blocked</li> <li>• Only the websites that appear as links on the WebVPN home page are available</li> </ul> |

Table 29-6 WebVPN Remote System Configuration and End User Requirements (continued)

| Task                                 | Remote System or End User Requirements                             | Specifications or Use Suggestions                                                                                                                                                                              |
|--------------------------------------|--------------------------------------------------------------------|----------------------------------------------------------------------------------------------------------------------------------------------------------------------------------------------------------------|
| Network Browsing and File Management | File permissions configured for shared remote access               | Only shared folders and files are accessible via WebVPN.                                                                                                                                                       |
|                                      | Server name and passwords for protected file servers               |                                                                                                                                                                                                                |
|                                      | Domain, workgroup, and server names where folders and files reside | Users might not be familiar with how to locate their files through your organization network.                                                                                                                  |
|                                      | Patience                                                           | Do not interrupt the <b>Copy File to Server</b> command or navigate to a different screen while the copying is in progress. Interrupting the operation can cause an incomplete file to be saved on the server. |

Table 29-6 WebVPN Remote System Configuration and End User Requirements (continued)

| Task                                                                 | Remote System or End User Requirements                                                                                                                                                                                                                                                                                                                                                                                                                                                                                                                                                  | Specifications or Use Suggestions                                                                                                                                                                                                                                                                                                                                                                                                                                                                                                                                                                                                         |
|----------------------------------------------------------------------|-----------------------------------------------------------------------------------------------------------------------------------------------------------------------------------------------------------------------------------------------------------------------------------------------------------------------------------------------------------------------------------------------------------------------------------------------------------------------------------------------------------------------------------------------------------------------------------------|-------------------------------------------------------------------------------------------------------------------------------------------------------------------------------------------------------------------------------------------------------------------------------------------------------------------------------------------------------------------------------------------------------------------------------------------------------------------------------------------------------------------------------------------------------------------------------------------------------------------------------------------|
| Using Applications<br>(called Port Forwarding or Application Access) | <b>Note</b>                                                                                                                                                                                                                                                                                                                                                                                                                                                                                                                                                                             | On Macintosh OS X, only the Safari browser supports this feature.                                                                                                                                                                                                                                                                                                                                                                                                                                                                                                                                                                         |
|                                                                      | <b>Note</b>                                                                                                                                                                                                                                                                                                                                                                                                                                                                                                                                                                             | Because this feature requires installing Sun Microsystems Java™ Runtime Environment and configuring the local clients, and because doing so requires administrator permissions on the local system, it is unlikely that users will be able to use applications when they connect from public remote systems.                                                                                                                                                                                                                                                                                                                              |
|                                                                      |  <b>Caution</b>                                                                                                                                                                                                                                                                                                                                                                                                                                                                                        | Users should always close the Application Access window when they finish using applications by clicking the <b>Close</b> icon. Failure to quit the window properly can cause Application Access or the applications themselves to be disabled. See <a href="#">Recovering from hosts File Errors in Application Access</a> for details.                                                                                                                                                                                                                                                                                                   |
|                                                                      | Client applications installed                                                                                                                                                                                                                                                                                                                                                                                                                                                                                                                                                           |                                                                                                                                                                                                                                                                                                                                                                                                                                                                                                                                                                                                                                           |
|                                                                      | Cookies enabled on browser                                                                                                                                                                                                                                                                                                                                                                                                                                                                                                                                                              |                                                                                                                                                                                                                                                                                                                                                                                                                                                                                                                                                                                                                                           |
|                                                                      | Administrator privileges                                                                                                                                                                                                                                                                                                                                                                                                                                                                                                                                                                | User must be local administrator on the PC if you use DNS names to specify servers. This is because modifying the hosts file requires administrator privileges.                                                                                                                                                                                                                                                                                                                                                                                                                                                                           |
|                                                                      | Sun Microsystems Java Runtime Environment (JRE) version 1.4.x and 1.5.x installed.<br><br>Javascript must be enabled on the browser. By default, it is enabled.                                                                                                                                                                                                                                                                                                                                                                                                                         | If JRE is not installed, a pop-up window displays, directing users to a site where it is available.<br><br>On rare occasions, the WebVPN port forwarding applet fails with JAVA exception errors. If this happens, do the following: <ol style="list-style-type: none"> <li>1. Clear the browser cache and close the browser.</li> <li>2. Verify that no JAVA icons are in the computer task bar. Close all instances of JAVA.</li> <li>3. Establish a WebVPN session and launch the port forwarding JAVA applet.</li> </ol>                                                                                                              |
|                                                                      | Client applications configured, if necessary.<br><b>Note</b> The Microsoft Outlook client does not require this configuration step.<br><br>All non-Windows client applications require configuration.<br><br>To see if configuration is necessary for a Windows application, check the value of the Remote Server. <ul style="list-style-type: none"> <li>• If the Remote Server contains the server hostname, you do not need to configure the client application.</li> <li>• If the Remote Server field contains an IP address, you must configure the client application.</li> </ul> | To configure the client application, use the server's locally mapped IP address and port number. To find this information: <ol style="list-style-type: none"> <li>1. Start WebVPN on the remote system and click the Application Access link on the WebVPN home page. The Application Access window displays.</li> <li>2. In the Name column, find the name of the server you want to use, then identify its corresponding client IP address and port number (in the Local column).</li> <li>3. Use this IP address and port number to configure the client application. Configuration steps vary for each client application.</li> </ol> |
|                                                                      | <b>Note</b>                                                                                                                                                                                                                                                                                                                                                                                                                                                                                                                                                                             | When you use an application over WebVPN, for example Outlook over Port Forwarding, if the application presents a URL, for example a URL within an email, clicking the URL does not open the site over WebVPN. You must cut and paste the URL into the <b>Enter WebVPN (URL) Address</b> box on the WebVPN home page to open the site in WebVPN.                                                                                                                                                                                                                                                                                           |

Table 29-6 WebVPN Remote System Configuration and End User Requirements (continued)

| Task                               | Remote System or End User Requirements                                                                                                                                                                       | Specifications or Use Suggestions                                                                                                                                                                                                                                                                                                              |
|------------------------------------|--------------------------------------------------------------------------------------------------------------------------------------------------------------------------------------------------------------|------------------------------------------------------------------------------------------------------------------------------------------------------------------------------------------------------------------------------------------------------------------------------------------------------------------------------------------------|
| Using Email via Application Access | Fulfill requirements for Application Access (See Using Applications)                                                                                                                                         | To use mail, start Application Access from the WebVPN home page. The mail client is then available for use.                                                                                                                                                                                                                                    |
|                                    | <p><b>Note</b> If you are using an IMAP client and you lose your mail server connection or are unable to make a new connection, close the IMAP application and restart WebVPN.</p> <p>Other mail clients</p> | <p>We have tested Microsoft Outlook Express versions 5.5 and 6.0.</p> <p>WebVPN should support other SMTPS, POP3S, or IMAP4S email programs via port forwarding, such as Netscape Mail, Lotus Notes, and Eudora, but we have not verified them.</p>                                                                                            |
| Using Email via Web Access         | Web-based email product installed                                                                                                                                                                            | <p>Supported:</p> <ul style="list-style-type: none"> <li>Outlook Web Access</li> </ul> <p>For best results, use OWA on Internet Explorer 6.x or higher, Mozilla 1.7, or Firefox 1.x.</p> <ul style="list-style-type: none"> <li>Louts iNotes</li> </ul> <p>Other web-based email products should also work, but we have not verified them.</p> |
| Using Email via Email Proxy        | <p>SSL-enabled mail application installed</p> <p>Do not set the security appliance SSL version to TLSv1 Only. Outlook and Outlook Express do not support TLS.</p>                                            | <p>Supported mail applications:</p> <ul style="list-style-type: none"> <li>Microsoft Outlook</li> <li>Microsoft Outlook Express versions 5.5 and 6.0</li> <li>Netscape Mail version 7</li> <li>Eudora 4.2 for Windows 2000</li> </ul> <p>Other SSL-enabled mail clients should also work, but we have not verified them.</p>                   |
|                                    | Mail application configured                                                                                                                                                                                  | See instructions and examples for your mail application in the “Configuring Email” section.                                                                                                                                                                                                                                                    |

## Recovering from hosts File Errors in Application Access

It is very important to close the Application Access window properly. When you finish using Application Access, click the close icon. If you do not close the window properly:

- The next time you try to start Application Access, it might be disabled; you receive a Backup HOSTS File Found error message.
- The applications themselves might be disabled or might malfunction, even when you are running them locally.

These errors can result from terminating the Application Access window in any improper way. For example:

- Your browser crashes while you are using Application Access.
- A power outage or system shutdown occurs while you are using Application Access.
- You minimize the Application Access window while you are working, then shut down your computer with the window active (but minimized).

This section includes the following topics:

- [Understanding the hosts File](#)
- [Stopping Application Access Improperly](#)
- [Reconfiguring hosts Files](#)

## Understanding the hosts File

The hosts file on your local system maps IP addresses to host names. When you start Application Access, WebVPN modifies the hosts file, adding WebVPN-specific entries. Stopping Application Access by properly closing the Application Access window returns the file to its original state.

|                                       |                                                                                                                                                                                                               |
|---------------------------------------|---------------------------------------------------------------------------------------------------------------------------------------------------------------------------------------------------------------|
| Before invoking Application Access... | hosts file is in original state.                                                                                                                                                                              |
| When Application Access starts....    | <ul style="list-style-type: none"> <li>• WebVPN copies the hosts file to hosts.webvpn, thus creating a backup.</li> <li>• WebVPN then edits the hosts file, inserting WebVPN-specific information.</li> </ul> |
| When Application Access stops...      | <ul style="list-style-type: none"> <li>• WebVPN copies the backup file to the hosts file, thus restoring the hosts file to its original state.</li> <li>• WebVPN deletes hosts.webvpn.</li> </ul>             |
| After finishing Application Access... | hosts file is in original state.                                                                                                                                                                              |



### Note

Microsoft anti-spyware software blocks changes that the port forwarding JAVA applet makes to the hosts file. See [www.microsoft.com](http://www.microsoft.com) for information on how to allow hosts file changes when using anti-spyware software.

## Stopping Application Access Improperly

Once Application Access terminates abnormally, the hosts file is left in a WebVPN-customized state. WebVPN checks for this possibility the next time you start Application Access by searching for a hosts.webvpn file. If it finds one, you receive a Backup HOSTS File Found error message(see [Figure 29-4](#)), and Application Access is temporarily disabled.

Once you shut down Application Access improperly, you leave your remote access client/server applications in limbo. If you try to start these applications without using WebVPN, they might malfunction. You might find that hosts that you normally connect to are unavailable. This situation could commonly occur if you run applications remotely from home, fail to quit the Application Access window before shutting down the computer, then try to run the applications later from the office.

## Reconfiguring hosts Files

To reenable Application Access or malfunctioning applications:

- If you are able to connect to your remote access server, follow the steps in the section “[Reconfiguring hosts File Automatically Using WebVPN.](#)”
- If you are unable to connect to your remote access server from your current location or if you have made custom edits to the hosts file, follow the steps in the section “[Reconfiguring hosts File Manually.](#)”

## Reconfiguring hosts File Automatically Using WebVPN

If you are able to connect to your remote access server, follow these steps to reconfigure the hosts file and reenable both Application Access and the applications.

- 
- Step 1** Start WebVPN and log in. The home page opens.
- Step 2** Click the **Applications Access** link. A Backup HOSTS File Found message displays. (See [Figure 29-4.](#))

**Figure 29-4 Backup HOSTS File Found Message**

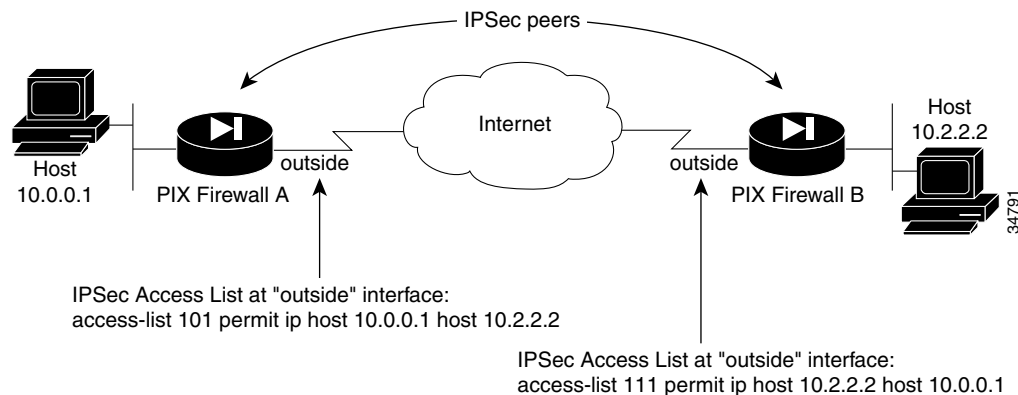

- Step 3** Choose one of the following options:
- **Restore from backup** = WebVPN forces a proper shutdown. WebVPN copies the hosts.webvpn backup file to the hosts file, restoring it to its original state, then deletes hosts.webvpn. You then have to restart Application Access.
  - **Do nothing** = Application Access does not start. You return to your remote access home page.
  - **Delete backup** = WebVPN deletes the hosts.webvpn file, leaving the hosts file in its WebVPN-customized state. The original hosts file settings are lost. Then Application Access starts, using the WebVPN-customized hosts file as the new original. Choose this option only if you are



unconcerned about losing hosts file settings. If you or a program you use might have edited the hosts file after Application Access has shut down improperly, choose one of the other options, or edit the hosts file manually. (See the “[Reconfiguring hosts File Manually](#)” section.)

## Reconfiguring hosts File Manually

If you are not able to connect to your remote access server from your current location, or if you have customized the hosts file and do not want to lose your edits, follow these steps to reconfigure the hosts file and reenable both Application Access and the applications.

**Step 1** Locate and edit your hosts file.

**Step 2** Check to see if any lines contain the string: # added by WebVpnPortForward  
If any lines contain this string, your hosts file is WebVPN-customized. If your hosts file is WebVPN-customized, it looks similar to the following example:

```
123.0.0.3 server1 # added by WebVpnPortForward
123.0.0.3 server1.example.com vpn3000.com # added by WebVpnPortForward
123.0.0.4 server2 # added by WebVpnPortForward
123.0.0.4 server2.example.com.vpn3000.com # added by WebVpnPortForward
123.0.0.5 server3 # added by WebVpnPortForward
123.0.0.5 server3.example.com vpn3000.com # added by WebVpnPortForward

Copyright (c) 1993-1999 Microsoft Corp.
#
This is a sample HOSTS file used by Microsoft TCP/IP for Windows.
#
This file contains the mappings of IP addresses to host names. Each
entry should be kept on an individual line. The IP address should
be placed in the first column followed by the corresponding host name.
The IP address and the host name should be separated by at least one
space.
#
Additionally, comments (such as these) may be inserted on individual
lines or following the machine name denoted by a '#' symbol.
#
For example:
#
102.54.94.97 cisco.example.com # source server
38.25.63.10 x.example.com # x client host

123.0.0.1 localhost
```

**Step 3** Delete the lines that contain the string: # added by WebVpnPortForward

**Step 4** Save and close the file.

**Step 5** Start WebVPN and log in. The home page appears.

**Step 6** Click the Application Access link. The Application Access window appears. Application Access is now enabled.

## Capturing WebVPN Data

WebVPN capture lets you log information about websites that do not display properly over a WebVPN connection. The data recorded can help your Cisco customer support engineer troubleshoot problems.



### Note

Enabling WebVPN capture affects the performance of the security appliance. Be sure to disable the capture after you generate the capture files that you need for troubleshooting.

## WebVPN Capture Files

When you enable WebVPN capture using the **capture** command, the security appliance stores the data from the first URL visited in the following files:

- *capture name\_ORIGINAL.000*—Contains the data exchanged between the security appliance and the web server.
- *capture name\_MANGLED.000*—Contains the data exchanged between the security appliance and the browser.

For each subsequent capture, the security appliance generates additional pairs of matching *capture name\_ORIGINAL.<nnn>* and *capture name\_MANGLED.<nnn>* files and increments the file extensions. In the following example, the capture name *sales* was assigned to the capture, and the output of the **dir** command displays three sets of files from three URL captures:

```
hostname# dir
Directory of disk0:/
2952 -rw- 10931 10:38:32 Jan 19 2005 config
6 -rw- 5124096 19:43:32 Jan 01 2003 cdisk.bin
3397 -rw- 5157 08:30:56 Feb 14 2005 sales_ORIGINAL.000
3398 -rw- 6396 08:30:56 Feb 14 2005 sales_MANGLED.000
3399 -rw- 4928 08:32:51 Feb 14 2005 sales_ORIGINAL.001
3400 -rw- 6167 08:32:51 Feb 14 2005 sales_MANGLED.001
3401 -rw- 5264 08:35:23 Feb 14 2005 sales_ORIGINAL.002
3402 -rw- 6503 08:35:23 Feb 14 2005 sales_MANGLED.002
hostname#
```

## Activating the WebVPN Capture Tool



### Note

When you activate WebVPN capture, the  icon appears in the WebVPN window.

To activate WebVPN capture, use the **capture** command from privileged EXEC mode.

```
capture capture-name type webvpn user webvpn-user [url url]
```

```
no capture capture-name
```

where:

- *capture-name* is a name you assign to the capture, which is also prepended to the name of the capture files.
- *webvpn-user* is the username to match for capture.
- *url* is the URL prefix to match for data capture. Use one of the following two URL formats:

- Use `http://server/path` to capture HTTP traffic to the server identified by `server/path`.
- Use `https://server/path` to capture HTTPS traffic to the server identified by `server/path`.

If no URL is specified, all traffic is logged.

The following example creates a capture designated *hr*, which is configured to capture HTTP traffic for user2 visiting website *wwin.abcd.com/hr/people*:

```
hostname# capture hr type webvpn user user2 url http://wwin.abcd.com/hr/people
WebVPN capture started.
 capture name hr
 user name user2
 url /http/0/wwin.abcd.com/hr/people
hostname#
```

## Locating and Uploading the WebVPN Capture Tool Output Files

To locate the WebVPN capture tool output files, use the **dir** command. The following example shows the output of the **dir** command including the ORIGINAL.000 and MANGLED.000 files that were generated:

```
hostname# dir
Directory of disk0:/
2952 -rw- 10931 10:38:32 Jan 19 2005 config
6 -rw- 5124096 19:43:32 Jan 01 2003 cdisk.bin
3397 -rw- 5157 08:30:56 Feb 14 2005 hr_ORIGINAL.000
3398 -rw- 6396 08:30:56 Feb 14 2005 hr_MANGLED.000
hostname#
```

You can upload the WebVPN capture tool output files to another computer using the **copy flash** command. In the following example, the **copy flash** command is used to upload the *hr\_ORIGINAL.000* and *hr\_MANGLED.000* files via tftp:

```
hostname# copy flash:/hr_original.000 tftp://10.86.194.191/hr_original.000
Source filename [hr_original.000]?
Address or name of remote host [10.86.194.191]?
Destination filename [hr_original.000]?
!!!!!!
21601 bytes copied in 0.370 secs

hostname# copy flash:/hr_mangled.000 tftp://10.86.194.191/hr_mangled.000
Source filename [hr_mangled.000]?
Address or name of remote host [10.86.194.191]?
Destination filename [hr_mangled.000]?
!!!!!!
23526 bytes copied in 0.380 secs

hostname#
```



### Note

To conserve flash memory, delete the capture files from the security appliance when you no longer need them.



## Configuring Certificates

---

This chapter describes how to configure certificates. CAs are responsible for managing certificate requests and issuing digital certificates. A digital certificate contains information that identifies a user or device. Some of this information can include a name, serial number, company, department, or IP address. A digital certificate also contains a copy of the public key for the user or device. A CA can be a trusted third party, such as VeriSign, or a private (in-house) CA that you establish within your organization.

This chapter includes the following sections:

- [Public Key Cryptography, page 30-1](#)
- [Certificate Configuration, page 30-4](#)

### Public Key Cryptography

This section includes the following topics:

- [About Public Key Cryptography, page 30-1](#)
- [Certificate Scalability, page 30-2](#)
- [About Key Pairs, page 30-2](#)
- [About Trustpoints, page 30-3](#)
- [About CRLs, page 30-3](#)
- [Supported CA Servers, page 30-4](#)

### About Public Key Cryptography

Digital signatures, enabled by public key cryptography, provide a means to authenticate devices and users. In public key cryptography, such as the RSA encryption system, each user has a key pair containing both a public and a private key. The keys act as complements, and anything encrypted with one of the keys can be decrypted with the other.

In simple terms, a signature is formed when data is encrypted with a private key. The signature is attached to the data and sent to the receiver. The receiver applies the public key of the sender to the data. If the signature sent with the data matches the result of applying the public key to the data, the validity of the message is established.

This process relies on the receiver having a copy of the public key of the sender and having a high degree of certainty that this key belongs to the sender, not to someone pretending to be the sender.

Obtaining the public key of a sender is normally handled out-of-band or through an operation done at installation. For instance, most web browsers are configured with the root certificates of several CAs by default. For VPN, the IKE protocol, a component of IPSec, can use digital signatures to authenticate peer devices before setting up security associations.

## Certificate Scalability

Without digital certificates, you must manually configure each IPSec peer for every peer with which it communicates, and every new peer you add to a network would thus require a configuration change on every peer with which you need it to communicate securely.

When you use digital certificates, each peer is enrolled with a CA. When two peers attempt to communicate, they exchange certificates and digitally sign data to authenticate each other. When a new peer is added to the network, you enroll that peer with a CA and none of the other peers need modification. When the new peer attempts an IPSec connection, certificates are automatically exchanged and the peer can be authenticated.

With a CA, a peer authenticates itself to the remote peer by sending a certificate to the remote peer and performing some public key cryptography. Each peer sends its unique certificate which was issued by the CA. This process works because each certificate encapsulates the public key for the associated peer and each certificate is authenticated by the CA, and all participating peers recognize the CA as an authenticating authority. This is called IKE with an RSA signature.

The peer can continue sending its certificate for multiple IPSec sessions, and to multiple IPSec peers, until the certificate expires. When its certificate expires, the peer administrator must obtain a new one from the CA.

CAs can also revoke certificates for peers that no longer participate in IPSec. Revoked certificates are not recognized as valid by other peers. Revoked certificates are listed in a CRL, which each peer may check before accepting a certificate from another peer.

Some CAs have an RA as part of their implementation. An RA is a server that acts as a proxy for the CA so that CA functions can continue when the CA is unavailable.

## About Key Pairs

Key pairs can be either RSA keys or DSA keys. Support for these two types of keys differs as follows.

- DSA keys cannot be used for SSH or SSL. To enable SSH or SSL access to a security appliance, you must use RSA keys.
- SCEP enrollment is only supported for the certification of RSA keys. If you use DSA keys, enrollment must be performed manually.
- For the purposes of generating keys, the maximum key modulus for RSA keys is 2048 while the maximum key modulus for DSA keys is 1024. When you generate keys, the default size for either key type is 1024.
- For signature operations, the supported maximum key sizes are 4096 bits for RSA keys and 1024 bits for DSA keys.
- You can generate a general purpose RSA key pair, used for both signing and encryption, or you can generate separate RSA key pairs for each purpose. You can only generate a DSA key pair for signing purposes.

Separate signing and encryption keys helps reduce exposure of the keys. This is because SSL uses a key for encryption but not signing but IKE uses a key for signing but not encryption. By using separate keys for each, exposure of the keys is minimized.

## About Trustpoints

Trustpoints let you manage and track CAs and certificates. A trustpoint is a representation of a CA or identity pair. A trustpoint contains the identity of the CA, CA-specific configuration parameters, and an association with one enrolled identity certificate.

After you have defined a trustpoint, you can reference it by name in commands requiring that you specify a CA. You can configure many trustpoints.



### Note

---

If a security appliance has trustpoints that share the same CA, only one trustpoint sharing the CA can be used to validate user certificates. Use the **support-user-cert-validation** command to control which trustpoint sharing a CA is used for validation of user certificates issued by that CA.

---

For automatic enrollment, a trustpoint must be configured with an enrollment URL and the CA that the trustpoint represents must be available on the network and must support SCEP.

You can export and import the keypair and issued certificates associated with a trustpoint in PKCS12 format. This is useful if you wish to manually duplicate a trustpoint configuration on a different security appliance.

## About CRLs

CRLs provide the security appliance with a means of determining whether a certificate that is within its valid time range has been revoked by its issuing CA. You can configure the security appliance to make CRL checks mandatory when authenticating a certificate. You can also make the CRL check optional, which allows the certificate authentication to succeed when the CA is unavailable to provide updated CRL data.

CRL configuration is a part of the configuration of each trustpoint you define. The security appliance can retrieve CRLs from CAs using HTTP, SCEP, or LDAP. CRLs retrieved for each trustpoint are cached for a length of time configurable for each trustpoint.

When the security appliance has cached a CRL for more than the length of time it is configured to cache CRLs, the security appliance considers the CRL too old to be reliable, or “stale”. The security appliance attempts to retrieve a newer version of the CRL the next time a certificate authentication requires that the stale CRL is checked.

The security appliance caches CRLs for a length of time determined by the following two factors:

- The number of minutes specified with the **cache-time** command. The default value is 60 minutes.
- The NextUpdate field in the CRLs retrieved, which may be absent from CRLs. You control whether the security appliance requires and uses the NextUpdate field with the **enforcenextupdate** command.

The security appliance uses these two factors as follows:

- If the NextUpdate field is not required, the security appliance marks CRLs as stale after the length of time defined by the **cache-time** command.
- If the NextUpdate field is required, the security appliance marks CRLs as stale at the sooner of the two times specified by the **cache-time** command and the NextUpdate field. For example, if the cache-time command is set to 100 minutes and the NextUpdate field specifies that the next update is 70 minutes away, the security appliance marks CRLs as stale in 70 minutes.

If the security appliance has insufficient memory to store all CRLs cached for a given trustpoint, it deletes the least recently used CRL to make room for a newly retrieved CRL.

For information about configuring CRL behavior for a trustpoint, see the [“Configuring CRLs for a Trustpoint”](#) section on page 30-12.

## Supported CA Servers

The security appliance supports the following CA servers:

- Cisco IOS CS
- Baltimore Technologies
- Entrust
- Microsoft Certificate Services
- Netscape CMS
- RSA Keon
- VeriSign

## Certificate Configuration

This section describes how to configure the security appliance with certificates and other procedures related to certificate use and management.

This section includes the following topics:

- [Preparing for Certificates, page 30-4](#)
- [Configuring Key Pairs, page 30-5](#)
- [Configuring Trustpoints, page 30-6](#)
- [Obtaining Certificates, page 30-8](#)
- [Configuring CRLs for a Trustpoint, page 30-12](#)
- [Exporting and Importing Trustpoints, page 30-14](#)
- [Configuring CA Certificate Map Rules, page 30-15](#)

## Preparing for Certificates

Before you configure a security appliance with certificates, ensure that the security appliance is configured properly to support certificates. An improperly configured security appliance can cause enrollment to fail or for enrollment to request a certificate containing inaccurate information.



To prepare a security appliance for certificates, perform the following steps:

- 
- Step 1** Ensure that the hostname and domain name of the security appliance are configured correctly. You can use the **show running-config** command to view the hostname and domain name as currently configured. For information about configuring the hostname, see the “[Setting the Hostname](#)” section on page 7-2. For information about configuring the domain name, see the “[Setting the Domain Name](#)” section on page 7-2.
- Step 2** Be sure that the security appliance clock is set accurately before configuring the CA. Certificates have a date and time that they become valid and that they expire. When the security appliance enrolls with a CA and gets a certificate, the security appliance checks that the current time is within the valid range for the certificate. If it is outside that range, enrollment fails. For information about setting the clock, see the “[Setting the Date and Time](#)” section on page 7-2.
- 

## Configuring Key Pairs

This section includes the following topics:

- [Generating Key Pairs, page 30-5](#)
- [Removing Key Pairs, page 30-6](#)

## Generating Key Pairs

Key pairs can be either RSA keys or DSA keys, as discussed in the “[About Key Pairs](#)” section on page 30-2. You must generate key pairs for the types of certification you want to use.

To generate key pairs, perform the following steps:

- 
- Step 1** Generate the types of key pairs needed for your PKI implementation. To do so, perform the following steps, as applicable:
- a. If you want to generate RSA key pairs, use the **crypto key generate rsa** command.  

```
hostname/contexta(config)# crypto key generate rsa
```

If you do not use additional keywords this command generates one general purpose RSA key pair. Because the key modulus is not specified, the default key modulus of 1024 is used. You can specify other modulus sizes with the **modulus** keyword. You can also assign a label to each key pair using the **label** keyword. The label is referenced by the trustpoint that uses the key pair. If you do not assign a label, the key pair is automatically labeled <Default-RSA-Key>.
  - b. If you want to generate DSA key pairs, use the **crypto key generate dsa** command.  

```
hostname/contexta(config)# crypto key generate dsa label key-pair-label
```

This command generates one DSA key pair. Because the key modulus is not specified, the default key modulus of 1024 is used. You can specify other modulus sizes with the **modulus** keyword. You must assign a label to the key pair using the **label** keyword. When you configure a trustpoint, you can specify a key pair using its label.

**Note**

When generating DSA keys, you may encounter a delay. On a Cisco PIX 515E Firewall, this delay may extend up to few minutes.

- Step 2** (Optional) Use the **show crypto key mypubkey** command to view key pair(s). Use the **rsa** and **dsa** keywords to specify which type of keys you want to view. The following example shows an RSA general-purpose key:

```
hostname/contexta(config)# show crypto key mypubkey rsa
Key pair was generated at: 16:39:47 central Feb 10 2005
Key name: <Default-RSA-Key>
Usage: General Purpose Key
Modulus Size (bits): 1024
Key Data:

30819f30 0d06092a 864886f7 0d010101 05000381 8d003081 89028181 00ea51b7
0781848f 78bccac2 4a1b5b8d 2f3e30b4 4cae9f86 f4485207 159108c9 f5e49103
9eeb0f5d 45fd1811 3b4aafce 292b3b64 b4124a6f 7a777b08 75b88df1 8092a9f8
5508e9e5 2c271245 7fd1c0c3 3aaf1e04 c7c4efa4 600f4c4a 6afe56ad c1d2c01c
e08407dd 45d9e36e 8cc0bfe4 14f9e6ac eca141e4 276d7358 f7f50d13 79020301 0001
Key pair was generated at: 16:34:54 central Feb 10 2005
```

- Step 3** Save the key pair you have generated. To do so, save the running configuration by entering the **write memory** command.

## Removing Key Pairs

To remove key pairs, use the **crypto key zeroize** command in global configuration mode.

The following example removes RSA key pairs:

```
hostname(config)# crypto key zeroize rsa
WARNING: All RSA keys will be removed.
WARNING: All device certs issued using these keys will also be removed.

Do you really want to remove these keys? [yes/no] y
hostname(config)#
```

## Configuring Trustpoints

For information about trustpoints, see the [“About Trustpoints” section on page 30-3](#).

To configure a trustpoint, perform the following steps:

- Step 1** Create a trustpoint corresponding to the CA from which the security appliance needs to receive its certificate.

```
hostname/contexta(config)# crypto ca trustpoint trustpoint
```

For example, to declare a trustpoint called Main:

```
hostname/contexta(config)# crypto ca trustpoint Main
hostname/contexta(config-ca-trustpoint)#
```

Upon entering this command, you enter the Crypto ca trustpoint configuration mode.

**Step 2** Specify the enrollment method to be used with this trustpoint.



**Note** If the trustpoint uses DSA keys, enrollment must be manual. The security appliance does not support automatic enrollment for certification with DSA keys.

To specify the enrollment method, do one of the following items:

- To specify SCEP enrollment, use the **enrollment url** command to configure the URL to be used for SCEP enrollment with the trustpoint you declared. For example, if the security appliance requests certificates from trustpoint Main using the URL `http://10.29.67.142:80/certsrv/mscep/mscep.dll`, then the command would be as follows:

```
hostname/contexta(config-ca-trustpoint)# enrollment url
http://10.29.67.142:80/certsrv/mscep/mscep.dll
```

- To specify manual enrollment, use the **enrollment terminal** command to indicate that you will paste the certificate received from the CA into the terminal.

**Step 3** As needed, specify other characteristics for the trustpoint. The characteristics you need to define depend upon your CA and its configuration. You can specify characteristics for the trustpoint using the following commands. Refer to the *Cisco Security Appliance Command Reference* for complete descriptions and usage guidelines of these commands.

- **crl required | optional | nocheck**—Specifies CRL configuration options. When you enter the **crl** command with the **optional** keyword included within the command statement, certificates from peers can still be accepted by your security appliance even if the CRL is not accessible to your security appliance.



**Note** If you chose to enable required or optional CRL checking, be sure you configure the trustpoint for CRL management, which should be completed after you have obtained certificates. For details about configuring CRL management for a trustpoint, see the “Configuring CRLs for a Trustpoint” section on page 30-12.

- **crl configure**—Enters CRL configuration mode.
- **default enrollment**—Returns all enrollment parameters to their system default values. Invocations of this command do not become part of the active configuration.
- **enrollment retry period** —(Optional) Specifies a retry period in minutes. This characteristic only applies if you are using SCEP enrollment.
- **enrollment retry count**—(Optional) Specifies a maximum number of permitted retries. This characteristic only applies if you are using SCEP enrollment.
- **enrollment terminal**—Specifies cut and paste enrollment with this trustpoint.
- **enrollment url URL**—Specifies automatic enrollment (SCEP) to enroll with this trustpoint and configures the enrollment URL.
- **fqdn fqdn**—During enrollment, asks the CA to include the specified fully qualified domain name in the Subject Alternative Name extension of the certificate.
- **email address**—During enrollment, asks the CA to include the specified email address in the Subject Alternative Name extension of the certificate.
- **subject-name X.500 name**—During enrollment, asks the CA to include the specified subject DN in the certificate.

- **serial-number**—During enrollment, asks the CA to include the security appliance serial number in the certificate.
- **ip-address** *ip-address*—During enrollment, asks the CA to include the IP address of the security appliance in the certificate.
- **password** *string*—Specifies a challenge phrase that is registered with the CA during enrollment. The CA typically uses this phrase to authenticate a subsequent revocation request.
- **keypair** *name*—Specifies the key pair whose public key is to be certified.
- **id-cert-issuer**—Indicates whether the system accepts peer certificates issued by the CA associated with this trustpoint.
- **accept-subordinates**—Indicates whether CA certificates subordinate to the CA associated with the trustpoint are accepted if delivered during phase one IKE exchange when not previously installed on the device.
- **support-user-cert-validation**—If enabled, the configuration settings to validate a remote user certificate can be taken from this trustpoint, provided that this trustpoint is authenticated to the CA that issued the remote certificate.
- **exit**—Leaves the mode.

**Step 4** Save the trustpoint configuration. To do so, save the running configuration by entering the **write memory** command.

---

## Obtaining Certificates

The security appliance needs a CA certificate for each trustpoint and one or two certificates for itself, depending upon the configuration of the keys used by the trustpoint. If the trustpoint uses separate RSA keys for signing and encryption, the security appliance needs two certificates, one for each purpose. In other key configurations, only one certificate is needed.

The security appliance supports enrollment with SCEP and with manual enrollment, which lets you paste a base-64-encoded certificate directly into the terminal. For site-to-site VPNs, you must enroll each security appliance. For remote access VPNs, you must enroll each security appliance and each remote access VPN client.

This section includes the following topics:

- [Obtaining Certificates with SCEP, page 30-8](#)
- [Obtaining Certificates Manually, page 30-10](#)

## Obtaining Certificates with SCEP

This procedure provides steps for configuring certificates using SCEP. These steps should be repeated for each trustpoint you configure for automatic enrollment. When you have completed this procedure, the security appliance will have received a CA certificate for the trustpoint and one or two certificates for signing and encryption purposes. If you use DSA keys, the certificate received is for signing only. If you use general-purpose RSA keys, the certificate received is for signing and encryption. If you use separate RSA keys for signing and encryption, the security appliance receives separate certificates for each purpose.

**Note**

Whether a trustpoint uses SCEP for obtaining certificates is determined by the use of the **enrollment url** command when you configure the trustpoint (see the “[Configuring Trustpoints](#)” section on page 30-6).

To obtain certificates with SCEP, perform the following steps:

**Step 1** Obtain the CA certificate for the trustpoint you configured.

```
hostname/contexta(config)# crypto ca authenticate trustpoint
```

For example, using trustpoint named Main, which represents a subordinate CA:

```
hostname/contexta(config)# crypto ca authenticate Main
```

```
INFO: Certificate has the following attributes:
Fingerprint: 3736ffc2 243ecf05 0c40f2fa 26820675
Do you accept this certificate? [yes/no]: y
```

```
Trustpoint 'Main' is a subordinate CA and holds a non self signed cert.
Trustpoint CA certificate accepted.
```

**Step 2** Enroll the security appliance with the trustpoint. This process retrieves a certificate for signing data and, depending upon the type of keys you configured, for encrypting data.

**Step 3** To perform enrollment, use the **crypto ca enroll** command. Before entering this command, contact your CA administrator because the administrator may need to authenticate your enrollment request manually before the CA grants its certificates.

```
hostname(config)# crypto ca enroll trustpoint
```

If the security appliance does not receive a certificate from the CA within 1 minute (the default) of sending a certificate request, it resends the certificate request. The security appliance continues sending a certificate request every 1 minute until a certificate is received.

**Note**

If the fully qualified domain name configured for the trustpoint is not identical to the fully qualified domain name of the security appliance, including the case of the characters, a warning appears. If needed, you can exit the enrollment process, make any necessary corrections, and enter the **crypto ca enroll** command again.

The following enrollment example performs enrollment with the trustpoint named Main:

```
hostname(config)# crypto ca enroll Main
%
% Start certificate enrollment ..
% Create a challenge password. You will need to verbally provide this
% password to the CA Administrator in order to revoke your certificate.
% For security reasons your password will not be saved in the configuration.
% Please make a note of it.
Password: 2b0rn0t2b
Re-enter password: 2b0rn0t2b
% The subject name in the certificate will be: securityappliance.example.com
% The fully-qualified domain name in the certificate will be:
securityappliance.example.com
% Include the device serial number in the subject name? [yes/no]: no
Request certificate from CA [yes/no]: yes
% Certificate request sent to Certificate authority.
```



**Note** The password is required if the certificate for the security appliance needs to be revoked, so it is crucial that you remember this password. Note it and store it in a safe place.

You must enter the **crypto ca enroll** command for each trustpoint with which the security appliance needs to enroll.



**Note** If your security appliance reboots after you issued the **crypto ca enroll** command but before you received the certificate, reissue the **crypto ca enroll** command and notify the CA administrator.

**Step 4** Verify that the enrollment process was successful using the **show crypto ca certificate** command. For example, to show the certificate received from trustpoint Main:

```
hostname/contexta(config)# show crypto ca certificate Main
```

The output of this command shows the details of the certificate issued for the security appliance and the CA certificate for the trustpoint.

**Step 5** Save the configuration using the **write memory** command:

```
hostname/contexta(config)# write memory
```

## Obtaining Certificates Manually

This procedure provides steps for configuring certificates using manual certificate requests. These steps should be repeated for each trustpoint you configure for manual enrollment. When you have completed this procedure, the security appliance will have received a CA certificate for the trustpoint and one or two certificates for signing and encryption purposes. If you use DSA keys, the certificate received is for signing only. If you use general-purpose RSA keys, the certificate received is for signing and encryption. If you use separate RSA keys for signing and encryption, the certificates received are used for each purpose exclusively.



**Note** Whether a trustpoint requires that you manually obtain certificates is determined by the use of the **enrollment terminal** command when you configure the trustpoint (see the [“Configuring Trustpoints” section on page 30-6](#)).

To obtain certificates manually, perform the following steps:

**Step 1** Obtain a base-64 encoded CA certificate from the CA represented by the trustpoint.

**Step 2** Import the CA certificate. To do so, use the **crypto ca authenticate** command. The following example shows a CA certificate request for the trustpoint Main.

```
hostname (config)# crypto ca authenticate Main
Enter the base 64 encoded CA certificate.
End with a blank line or the word "quit" on a line by itself
MIIDRTCCAu+gAwIBAgIQKvcqP/KW74VP0NZzL+JbRTANBgkqhkiG9w0BAQUFADCB
[certificate data omitted]
/7QEM8izy0EOTSErKu7Nd76jwf5e4qtkkQ==
quit
```

```
INFO: Certificate has the following attributes:
Fingerprint: 24b81433 409b3fd5 e5431699 8d490d34
Do you accept this certificate? [yes/no]: y
Trustpoint CA certificate accepted.
```

```
% Certificate successfully imported
hostname (config)#
```

- Step 3** Generate a certificate request. To do so, use the **crypto ca enroll** command. The following example shows a certificate and encryption key request for the trustpoint Main, which is configured to use manual enrollment and general-purpose RSA keys for signing and encryption.

```
hostname (config)# crypto ca enroll Main
% Start certificate enrollment ..

% The fully-qualified domain name in the certificate will be:
securityappliance.example.com

% Include the device serial number in the subject name? [yes/no]: n

Display Certificate Request to terminal? [yes/no]: y
Certificate Request follows:

MIIBoDCCAQkCAQAwIzEhMB8GCSqGSIB3DQEJAhYSRmVyYWwQaXguY2l2Y28uY29t
[certificate request data omitted]
jF4waw68eOxQxVmdgMWeQ+RbIOYmvt8g6hnBTrd0GdqjjVLt

---End - This line not part of the certificate request---

Redisplay enrollment request? [yes/no]: n
hostname (config)#
```



---

**Note** If you use separate RSA keys for signing and encryption, the **crypto ca enroll** command displays two certificate requests, one for each key. To complete enrollment, acquire a certificate for all certificate requests generated by the **crypto ca enroll** command.

---

- Step 4** For each request generated by the **crypto ca enroll** command, obtain a certificate from the CA represented by the applicable trustpoint. Be sure the certificate is in base-64 format.

- Step 5** For each certificate you receive from the CA, use the **crypto ca import certificate** command. The security appliance prompts you to paste the certificate to the terminal in base-64 format.



---

**Note** If you use separate RSA key pairs for signing and encryption, perform this step for each certificate separately. The security appliance determines automatically whether the certificate is for the signing or encryption key pair. The order in which you import the two certificates is irrelevant.

---

The following example manually imports a certificate for the trustpoint Main:

```
hostname (config)# crypto ca import Main certificate
% The fully-qualified domain name in the certificate will be:
securityappliance.example.com

Enter the base 64 encoded certificate.
End with a blank line or the word "quit" on a line by itself
[certificate data omitted]
quit
INFO: Certificate successfully imported
hostname (config)#
```

- Step 6** Verify that the enrollment process was successful using the **show crypto ca certificate** command. For example, to show the certificate received from trustpoint Main:

```
hostname/contexta(config)# show crypto ca certificate Main
```

The output of this command shows the details of the certificate issued for the security appliance and the CA certificate for the trustpoint.

- Step 7** Save the configuration using the **write memory** command:

```
hostname/contexta(config)# write memory
```

## Configuring CRLs for a Trustpoint

If you want to use mandatory or optional CRL checking during certificate authentication, you must perform CRL configuration for each trustpoint. For more information about CRLs, see the [“About CRLs” section on page 30-3](#).

To configure CRLs for a trustpoint, perform the following steps:

- Step 1** Enter Crypto ca trustpoint configuration mode for the trustpoint whose CRL configuration you want to modify. To do so, enter the **crypto ca trustpoint** command.
- Step 2** If you have not already enabled CRLs, you can do so now by using the **crl** command with either the **required** or **optional** keyword. If you specify the **required** keyword, certificate authentication with this trustpoint cannot succeed if the CRL is unavailable.
- Step 3** Enter the **crl configure** command.

```
hostname/contexta(config-ca-trustpoint)# crl configure
hostname/contexta(config-ca-crl)#
```

Upon entering this command, you enter the crl configuration mode for the current trustpoint.



**Tip** To set all CRL configuration options to their default values, use the **default** command. At any time while performing CRL configuration, if you want to start over, enter this command and restart this procedure.



**Step 4** Configure the retrieval policy with the **policy** command. The following keywords for this command determine the policy.

- **cdp**—CRLs are retrieved only from the CRL distribution points specified in authenticated certificates.



---

**Note** SCEP retrieval is not supported by distribution points specified in certificates.

---

- **static**—CRLs are retrieved only from URLs you configure.
- **both**—CRLs are retrieved from CRL distribution points specified in authenticated certificates and from URLs you configure.

**Step 5** If you used the keywords **static** or **both** when you configured the CRL policy, you need to configure URLs for CRL retrieval, using the **url** command. You can enter up to 5 URLs, ranked 1 through 5.

```
hostname/contexta(config-ca-crl)# url n URL
```

where *n* is the rank assigned to the URL. To remove a URL, use the **no url n** command.

**Step 6** Configure the retrieval method with the **protocol** command. The following keywords for this command determine the retrieval method.

- **http**—Specifies HTTP as the CRL retrieval method.
- **ldap**—Specifies LDAP as the CRL retrieval method.
- **scep**—Specifies SCEP as the CRL retrieval method.

**Step 7** Configure how long the security appliance caches CRLs for the current trustpoint. To specify the number of minutes the security appliance waits before considering a CRL stale, enter the following command.

```
hostname/contexta(config-ca-crl)# cache-time n
```

where *n* is the number of minutes. For example, to specify that CRLs should be cached for seven hours, enter the following command.

```
hostname/contexta(config-ca-crl)# cache-time 420
```

**Step 8** Configure whether the security appliance requires the NextUpdate field in CRLs. For more information about how the security appliance uses the NextUpdate field, see the [“About CRLs” section on page 30-3](#).

Do one of the following:

- To require the NextUpdate field, enter the **enforcenextupdate** command. This is the default setting.
- To allow the NextUpdate field to be absent in CRLs, enter the **no enforcenextupdate** command.

**Step 9** If you specified LDAP as the retrieval protocol, perform the following steps:

- Enter the following command to identify the LDAP server to the security appliance:

```
hostname/contexta(config-ca-crl)# ldap-defaults server
```

You can specify the server by DNS hostname or by IP address. You can also provide a port number if the server listens for LDAP queries on a port other than the default of 389. For example, the following command configures the security appliance to retrieve CRLs from an LDAP server whose hostname is `ldap1`.

```
hostname/contexta(config-ca-crl)# ldap-defaults ldap1
```



**Note** If you use a hostname rather than an IP address to specify the LDAP server, be sure you have configured the security appliance to use DNS. For information about configuring DNS, see the **dns** commands in the *Cisco Security Appliance Command Reference*.

- b. If LDAP server requires credentials to permit CRL retrieval, enter the following command:

```
hostname/contexta(config-ca-crl)# ldap-dn admin-DN password
```

For example:

```
hostname/contexta(config-ca-crl)# ldap-dn cn=admin,ou=devtest,o=engineering c00lRunZ
```

**Step 10** To test CRL configuration for the current trustpoint, use the **crypto ca crl request** command. This command retrieves the current CRL from the CA represented by the trustpoint you specify.

**Step 11** Save the running configuration. Enter the **write memory** command.

## Exporting and Importing Trustpoints

You can export and import keypairs and issued certificates associated with a trustpoint configuration. The security appliance supports PKCS12 format for the export and import of trustpoints.

This section includes the following topics:

- [Exporting a Trustpoint Configuration, page 30-14](#)
- [Importing a Trustpoint Configuration, page 30-14](#)

### Exporting a Trustpoint Configuration

To export a trustpoint configuration with all associated keys and certificates in PKCS12 format, use the **crypto ca export** command. The security appliance displays the PKCS12 data in the terminal. You can copy the data. The trustpoint data is password protected; however, if you save the trustpoint data in a file, be sure the file is in a secure location.

The following example exports PKCS12 data for trustpoint Main using Wh0zits as the passphrase:

```
hostname (config)# crypto ca export Main pkcs12 Wh0zits
```

```
Exported pkcs12 follows:
```

```
[PKCS12 data omitted]
```

```
---End - This line not part of the pkcs12---
```

```
hostname (config)#
```

### Importing a Trustpoint Configuration

To import the keypairs and issued certificates associated with a trustpoint configuration, use the **crypto ca import pkcs12** command in global configuration mode. The security appliance prompts you to paste the text to the terminal in base-64 format.

The key pair imported with the trustpoint is assigned a label matching the name of the trustpoint you create. For example, if an exported trustpoint used an RSA key labeled <Default-RSA-Key>, creating trustpoint named Main by importing the PKCS12 creates a key pair named Main, not <Default-RSA-Key>.

**Note**

If a security appliance has trustpoints that share the same CA, only one of the trustpoints sharing the CA can be used to validate user certificates. The **crypto ca import pkcs12** command can create this situation. Use the **support-user-cert-validation** command to control which trustpoint sharing a CA is used for validation of user certificates issued by that CA.

The following example manually imports PKCS12 data to the trustpoint Main with the passphrase Wh0zits:

```
hostname (config)# crypto ca import Main pkcs12 Wh0zits

Enter the base 64 encoded pkcs12.
End with a blank line or the word "quit" on a line by itself:
[PKCS12 data omitted]
quit
INFO: Import PKCS12 operation completed successfully
hostname (config)#
```

## Configuring CA Certificate Map Rules

You can configure rules based on the Issuer and Subject fields of a certificate. Using the rules you create, you can map IPsec peer certificates to tunnel groups with the **tunnel-group-map** command. The security appliance supports one CA certificate map, which can contain many rules. For more information about using CA certificate map rules with tunnel groups, see the [“Creating a Certificate Group Matching Rule and Policy” section on page 23-10](#).

To configure a CA certificate map rule, perform the following steps:

- Step 1** Enter CA certificate map configuration mode for the rule you want to configure. To do so, enter the **crypto ca certificate map** command and specify the rule index number. The following example enters CA certificate map mode for the rule with index number 1.

```
hostname(config)# crypto ca certificate map 1
hostname(config-ca-cert-map)#
```

- Step 2** Use the **issuer-name** and **subject-name** commands to configure the rule. These commands specify tests that the security appliance can apply to values found in the Issuer or Subject fields of certificates. The tests can apply to specific attributes or to the whole of the Issuer or Subject fields. You can configure many tests per rule, and all the tests you specify with these commands must be true for a rule to match a certificate. Valid operators in the **issuer-name** and **subject-name** commands are as follows.

| Operator | Meaning                                                           |
|----------|-------------------------------------------------------------------|
| eq       | The field or attribute must be identical to the value given.      |
| ne       | The field or attribute cannot be identical to the value given.    |
| co       | Part or all of the field or attribute must match the value given. |
| nc       | No part of the field or attribute can match the value given.      |

For more information about the **issuer-name** and **subject-name** commands, see the *Cisco Security Appliance Command Reference*.

The following example specifies that any attribute within the Issuer field must contain the string cisco.

```
hostname(config-ca-cert-map)# issuer-name co cisco
hostname(config-ca-cert-map)#
```

The following example specifies that within the Subject field an Organizational Unit attribute must exactly match the string Engineering.

```
hostname(config-ca-cert-map)# subject-name attr ou eq Engineering
hostname(config-ca-cert-map)#
```

Map rules appear in the output of the **show running-config** command.

```
crypto ca certificate map 1
 issuer-name co cisco
 subject-name attr ou eq Engineering
```

**Step 3** When you have finished configuring the map rule, save your work. Enter the **write memory** command.

---



## **PART 4**

# **System Administration**







## Managing System Access

---

This chapter describes how to access the security appliance for system management through Telnet, SSH, and HTTPS. It also describes how to authenticate and authorize users and how to create login banners.

This chapter includes the following sections:

- [Allowing Telnet Access, page 31-1](#)
- [Allowing SSH Access, page 31-2](#)
- [Configuring SSH Access, page 31-2](#)
- [Using an SSH Client, page 31-3](#)
- [Changing the Login Password, page 31-3](#)
- [Allowing HTTPS Access for ASDM, page 31-4](#)
- [Authenticating and Authorizing System Administrators, page 31-4](#)
- [Configuring a Login Banner, page 31-16](#)

### Allowing Telnet Access

The security appliance allows Telnet connections to the security appliance for management purposes. You cannot use Telnet to the lowest security interface unless you use Telnet inside an IPSec tunnel.

The security appliance allows a maximum of 5 concurrent Telnet connections per context, if available, with a maximum of 100 connections divided between all contexts.

To configure Telnet access to the security appliance, follow these steps:

- Step 1** To identify the IP addresses from which the security appliance accepts connections, enter the following command for each address or subnet:

```
hostname(config)# telnet source_IP_address mask source_interface
```

If there is only one interface, you can configure Telnet to access that interface as long as the interface has a security level of 100.

- Step 2** (Optional) To set the duration for how long a Telnet session can be idle before the security appliance disconnects the session, enter the following command:

```
hostname(config)# telnet timeout minutes
```

Set the timeout from 1 to 1440 minutes. The default is 5 minutes. The default duration is too short in most cases and should be increased until all pre-production testing and troubleshooting has been completed.

For example, to let a host on the inside interface with an address of 192.168.1.2 access the security appliance, enter the following command:

```
hostname(config)# telnet 192.168.1.2 255.255.255.255 inside
hostname(config)# telnet timeout 30
```

To allow all users on the 192.168.3.0 network to access the security appliance on the inside interface, enter the following command:

```
hostname(config)# telnet 192.168.3.0 255.255.255.0 inside
```

## Allowing SSH Access

The security appliance allows SSH connections to the security appliance for management purposes. The security appliance allows a maximum of 5 concurrent SSH connections per context, if available, with a maximum of 100 connections divided between all contexts.

SSH is an application running on top of a reliable transport layer, such as TCP/IP, that provides strong authentication and encryption capabilities. The security appliance supports the SSH remote shell functionality provided in SSH Versions 1 and 2 and supports DES and 3DES ciphers.



### Note

XML management over SSL and SSH are not supported in PIX Version 7.0 and 7.0.

This section includes the following topics:

- [Configuring SSH Access, page 31-2](#)
- [Using an SSH Client, page 31-3](#)

## Configuring SSH Access

To configure SSH access to the security appliance, follow these steps:

**Step 1** To generate an RSA key pair, which is required for SSH, enter the following command:

```
hostname(config)# crypto key generate rsa modulus modulus_size
```

The modulus (in bits) is 512, 768, 1024, or 2048. The larger the key modulus size you specify, the longer it takes to generate an RSA. We recommend a value of 1024.

**Step 2** To save the RSA keys to persistent Flash memory, enter the following command:

```
hostname(config)# write mem
```

**Step 3** To identify the IP addresses from which the security appliance accepts connections, enter the following command for each address or subnet:

```
hostname(config)# ssh source_IP_address mask source_interface
```



The security appliance accepts SSH connections from all interfaces, including the one with the lowest security level.

- Step 4** (Optional) To set the duration for how long an SSH session can be idle before the security appliance disconnects the session, enter the following command:

```
hostname(config)# ssh timeout minutes
```

Set the timeout from 1 to 60 minutes. The default is 5 minutes. The default duration is too short in most cases and should be increased until all pre-production testing and troubleshooting has been completed.

---

For example, to generate RSA keys and let a host on the inside interface with an address of 192.168.1.2 access the security appliance, enter the following command:

```
hostname(config)# crypto key generate rsa modulus 1024
hostname(config)# write mem
hostname(config)# ssh 192.168.1.2 255.255.255.255 inside
hostname(config)# ssh 192.168.1.2 255.255.255.255 inside
hostname(config)# ssh timeout 30
```

To allow all users on the 192.168.3.0 network to access the security appliance on the inside interface, the following command:

```
hostname(config)# ssh 192.168.3.0 255.255.255.0 inside
```

By default SSH allows both version one and version two. To specify the version number enter the following command:

```
hostname(config)# ssh version version_number
```

The *version\_number* can be 1 or 2.

## Using an SSH Client

To gain access to the security appliance console using SSH, at the SSH client enter the username **pix** and enter the login password set by the **password** command (see the “[Changing the Login Password](#)” section on page 31-3).

When starting an SSH session, a dot (.) displays on the security appliance console before the SSH user authentication prompt appears, as follows:

```
hostname(config)# .
```

The display of the dot does not affect the functionality of SSH. The dot appears at the console when generating a server key or decrypting a message using private keys during SSH key exchange before user authentication occurs. These tasks can take up to two minutes or longer. The dot is a progress indicator that verifies that the security appliance is busy and has not hung.

## Changing the Login Password

The login password is used for Telnet and SSH connections. By default, the login password is “cisco.” To change the password, enter the following command:

```
hostname(config)# {passwd | password} password
```

You can enter **passwd** or **password**. The password is a case-sensitive password of up to 16 alphanumeric and special characters. You can use any character in the password except a question mark or a space.

The password is saved in the configuration in encrypted form, so you cannot view the original password after you enter it. Use the `no password` command to restore the password to the default setting.

## Allowing HTTPS Access for ASDM

To use ASDM, you need to enable the HTTPS server, and allow HTTPS connections to the security appliance. All of these tasks are completed if you use the `setup` command. This section describes how to manually configure ASDM access.

The security appliance allows a maximum of 5 concurrent ASDM instances per context, if available, with a maximum of 32 ASDM instances between all contexts.



### Note

WebVPN and ASDM administration cannot be enabled on the same interface. If you enable WebVPN on an interface, then that interface cannot be used for ASDM.

To configure ASDM access, follow these steps:

- Step 1** To identify the IP addresses from which the security appliance accepts HTTPS connections, enter the following command for each address or subnet:

```
hostname(config)# http source_IP_address mask source_interface
```

- Step 2** To enable the HTTPS server, enter the following command:

```
hostname(config)# http server enable
```

- Step 3** To specify the location of the ASDM image, enter the following command:

```
hostname(config)# asdm image disk0:/asdmfile
```

For example, to enable the HTTPS server and let a host on the inside interface with an address of 192.168.1.2 access ASDM, enter the following commands:

```
hostname(config)# crypto key generate rsa modulus 1024
hostname(config)# write mem
hostname(config)# http server enable
hostname(config)# http 192.168.1.2 255.255.255.255 inside
```

To allow all users on the 192.168.3.0 network to access ASDM on the inside interface, enter the following command:

```
hostname(config)# http 192.168.3.0 255.255.255.0 inside
```

## Authenticating and Authorizing System Administrators

This section describes how to enable authentication and command authorization for system administrators. Before you configure AAA for system administrators, first configure the local database or AAA server according to [Chapter 10, “AAA Server and Local Database Support.”](#)

This section includes the following topics:

- [Configuring Authentication for CLI Access, page 31-5](#)
- [Configuring Authentication To Access Privileged EXEC Mode, page 31-5](#)
- [Configuring Command Authorization, page 31-7](#)

## Configuring Authentication for CLI Access

If you enable CLI authentication, the security appliance prompts you for your username and password to log in. After you enter your information, you have access to user EXEC mode.

To enter privileged EXEC mode, enter the **enable** command or the **login** command (if you are using the local database only).

If you configure enable authentication (see the “[Configuring Authentication for the Enable Command](#)” section on page 31-6), the security appliance prompts you for your username and password. If you do not configure enable authentication, enter the system enable password when you enter the **enable** command (set by the **enable password** command). However, if you do not use enable authentication, after you enter the **enable** command, you are no longer logged in as a particular user. To maintain your username, use enable authentication.

For authentication using the local database, you can use the **login** command, which maintains the username but requires no configuration to turn on authentication.



### Note

Before the security appliance can authenticate a Telnet, SSH, or HTTP user, you must first configure access to the security appliance using the **telnet**, **ssh**, and **http** commands. These commands identify the IP addresses that are allowed to communicate with the security appliance.

To authenticate users who access the CLI, enter the following command:

```
hostname(config)# aaa authentication {telnet | ssh | http | serial} console {LOCAL |
server_group [LOCAL]}
```

The **http** keyword authenticates the ASDM client that accesses the security appliance using HTTPS. You only need to configure HTTP authentication if you want to use a RADIUS or TACACS+ server. By default, ASDM uses the local database for authentication even if you do not configure this command.

If you use a TACACS+ or RADIUS server group for authentication, you can configure the security appliance to use the local database as a fallback method if the AAA server is unavailable. Specify the server group name followed by **LOCAL** (**LOCAL** is case sensitive). We recommend that you use the same username and password in the local database as the AAA server because the security appliance prompt does not give any indication which method is being used.

You can alternatively use the local database as your main method of authentication (with no fallback) by entering **LOCAL** alone.

## Configuring Authentication To Access Privileged EXEC Mode

You can configure the security appliance to authenticate users with a AAA server or the local database when they enter the **enable** command. Alternatively, users are automatically authenticated with the local database when they enter the **login** command, which also accesses privileged EXEC mode depending on the user level in the local database.

This section includes the following topics:

- [Configuring Authentication for the Enable Command, page 31-6](#)
- [Authenticating Users Using the Login Command, page 31-6](#)

## Configuring Authentication for the Enable Command

You can configure the security appliance to authenticate users when they enter the **enable** command. If you do not authenticate the **enable** command, when you enter **enable**, the security appliance prompts for the system enable password (set by the **enable password** command), and you are no longer logged in as a particular user. Applying authentication to the **enable** command maintains the username. This feature is particularly useful when you perform command authorization, where usernames are important to determine the commands a user can enter.

To authenticate users who enter the **enable** command, enter the following command:

```
hostname(config)# aaa authentication enable console {LOCAL | server_group [LOCAL]}
```

The user is prompted for the username and password.

If you use a TACACS+ or RADIUS server group for authentication, you can configure the security appliance to use the local database as a fallback method if the AAA server is unavailable. Specify the server group name followed by **LOCAL** (**LOCAL** is case sensitive). We recommend that you use the same username and password in the local database as the AAA server because the security appliance prompt does not give any indication which method is being used.

You can alternatively use the local database as your main method of authentication (with no fallback) by entering **LOCAL** alone.

## Authenticating Users Using the Login Command

From user EXEC mode, you can log in as any username in the local database using the **login** command.

This feature allows users to log in with their own username and password to access privileged EXEC mode, so you do not have to give out the system enable password to everyone. To allow users to access privileged EXEC mode (and all commands) when they log in, set the user privilege level to 2 (the default) through 15. If you configure local command authorization, then the user can only enter commands assigned to that privilege level or lower. See the “[Configuring Local Command Authorization](#)” section on page 31-7 for more information.



### Caution

If you add users to the local database who can gain access to the CLI and whom you do not want to enter privileged EXEC mode, you should configure command authorization. Without command authorization, users can access privileged EXEC mode (and all commands) at the CLI using their own password if their privilege level is 2 or greater (2 is the default). Alternatively, you can use RADIUS or TACACS+ authentication, or you can set all local users to level 1 so you can control who can use the system enable password to access privileged EXEC mode.

To log in as a user from the local database, enter the following command:

```
hostname> login
```

The security appliance prompts for your username and password. After you enter your password, the security appliance places you in the privilege level that the local database specifies.

## Configuring Command Authorization

By default when you log in, you can access user EXEC mode, which offers only minimal commands. When you enter the **enable** command (or the **login** command when you use the local database), you can access privileged EXEC mode and advanced commands, including configuration commands. If you want to control the access to commands, the security appliance lets you configure command authorization, where you can determine which commands that are available to a user.

This section includes the following topics:

- [Command Authorization Overview, page 31-7](#)
- [Configuring Local Command Authorization, page 31-7](#)
- [Configuring TACACS+ Command Authorization, page 31-11](#)

### Command Authorization Overview

You can use one of two command authorization methods:

- Local database—Configure the command privilege levels on the security appliance. When a local user authenticates with the **enable** command (or logs in with the **login** command), the security appliance places that user in the privilege level that is defined by the local database. The user can then access commands at the user's privilege level and below.

**Note**

You can use local command authorization without any users in the local database and without CLI or enable authentication. Instead, when you enter the **enable** command, you enter the system enable password, and the security appliance places you in level 15. You can then create enable passwords for every level, so that when you enter **enable n** (2 to 15), the security appliance places you in level *n*. These levels are not used unless you turn on local command authorization (see “[Configuring Local Command Authorization](#)” below). (See the *Cisco Security Appliance Command Reference* for more information about **enable**.)

- TACACS+ server—On the TACACS+ server, configure the commands that a user or group can use after they authenticate for CLI access. Every command that a user enters at the CLI is checked with the TACACS+ server.

### Configuring Local Command Authorization

Local command authorization places each user at a privilege level, and each user can enter any command at their privilege level or below. The security appliance lets you assign commands to one of 16 privilege levels (0 to 15). By default, each command is assigned either to privilege level 0 or 15.

This section includes the following topics:

- [Local Command Authorization Prerequisites, page 31-8](#)
- [Default Command Privilege Levels, page 31-8](#)
- [Assigning Privilege Levels to Commands and Enabling Authorization, page 31-8](#)
- [Viewing Command Privilege Levels, page 31-10](#)

## Local Command Authorization Prerequisites

Complete the following tasks as part of your command authorization configuration:

- Configure **enable** authentication. (See the “[Configuring Authentication To Access Privileged EXEC Mode](#)” section on page 31-5.)

Alternatively, you can use the **login** command (which is the same as the **enable** command with authentication), which requires no configuration. We do not recommend this option because it is not as secure as enable authentication.

You can also use CLI authentication, but it is not required.

- Configure each user in the local database at a privilege level from 0 to 15.

## Default Command Privilege Levels

By default, the following commands are assigned to privilege level 0. All other commands are at level 15.

- **show checksum**
- **show curpriv**
- **enable** (enable mode)
- **help**
- **show history**
- **login**
- **logout**
- **pager**
- **show pager**
- **clear pager**
- **quit**
- **show version**

If you move any configure mode commands to a lower level than 15, be sure to move the **configure** command to that level as well, otherwise, the user will not be able to enter configuration mode.

To view all privilege levels, see the “[Viewing Command Privilege Levels](#)” section on page 31-10.

## Assigning Privilege Levels to Commands and Enabling Authorization

To assign a command to a new privilege level, and enable authorization, follow these steps:

- Step 1** To assign a command to a privilege level, enter the following command:

```
hostname(config)# privilege [show | clear | cmd] level level [mode {enable | cmd}] command
command
```

Repeat this command for each command you want to reassign.

See the following information about the options in this command:

- **show | clear | cmd**—These optional keywords let you set the privilege only for the show, clear, or configure form of the command. The configure form of the command is typically the form that causes a configuration change, either as the unmodified command (without the **show** or **clear** prefix) or as the **no** form. If you do not use one of these keywords, all forms of the command are affected.
- **level level**—A level between 0 and 15.
- **mode {enable | configure}**—If a command can be entered in user EXEC/privileged EXEC mode as well as configuration mode, and the command performs different actions in each mode, you can set the privilege level for these modes separately:
  - **enable**—Specifies both user EXEC mode and privileged EXEC mode.
  - **configure**—Specifies configuration mode, accessed using the **configure terminal** command.
- **command command**—The command you are configuring. You can only configure the privilege level of the *main* command. For example, you can configure the level of all **aaa** commands, but not the level of the **aaa authentication** command and the **aaa authorization** command separately.

Also, you cannot configure the privilege level of subcommands separately from the main command. For example, you can configure the **context** command, but not the **allocate-interface** command, which inherits the settings from the **context** command.

**Step 2** To enable local command authorization, enter the following command:

```
hostname(config)# aaa authorization command LOCAL
```

Even if you set command privilege levels, command authorization does not take place unless you enable command authorization with this command.

For example, the **filter** command has the following forms:

- **filter** (represented by the **configure** option)
- **show running-config filter**
- **clear configure filter**

You can set the privilege level separately for each form, or set the same privilege level for all forms by omitting this option. For example, set each form separately as follows.

```
hostname(config)# privilege show level 5 command filter
hostname(config)# privilege clear level 10 command filter
hostname(config)# privilege cmd level 10 command filter
```

Alternatively, you can set all filter commands to the same level:

```
hostname(config)# privilege level 5 command filter
```

The **show privilege** command separates the forms in the display.

The following example shows the use of the **mode** keyword. The **enable** command must be entered from user EXEC mode, while the **enable password** command, which is accessible in configuration mode, requires the highest privilege level.

```
hostname(config)# privilege cmd level 0 mode enable command enable
hostname(config)# privilege cmd level 15 mode cmd command enable
hostname(config)# privilege show level 15 mode cmd command enable
```

This example shows an additional command, the **configure** command, that uses the **mode** keyword:

```
hostname(config)# privilege show level 5 mode cmd command configure
hostname(config)# privilege clear level 15 mode cmd command configure
hostname(config)# privilege cmd level 15 mode cmd command configure
hostname(config)# privilege cmd level 15 mode enable command configure
```



**Note** This last line is for the **configure terminal** command.

## Viewing Command Privilege Levels

The following commands let you view privilege levels for commands.

- To show all commands, enter the following command:

```
hostname(config)# show running-config all privilege all
```

- To show commands for a specific level, enter the following command:

```
hostname(config)# show running-config privilege level level
```

The *level* is an integer between 0 and 15.

- To show the level of a specific command, enter the following command:

```
hostname(config)# show running-config privilege command command
```

For example, for the **show running-config all privilege all** command, the system displays the current assignment of each CLI command to a privilege level. The following is sample output from the command.

```
hostname(config)# show running-config all privilege all
privilege show level 15 command aaa
privilege clear level 15 command aaa
privilege configure level 15 command aaa
privilege show level 15 command aaa-server
privilege clear level 15 command aaa-server
privilege configure level 15 command aaa-server
privilege show level 15 command access-group
privilege clear level 15 command access-group
privilege configure level 15 command access-group
privilege show level 15 command access-list
privilege clear level 15 command access-list
privilege configure level 15 command access-list
privilege show level 15 command activation-key
privilege configure level 15 command activation-key
....
```

The following command displays the command assignments for privilege level 10:

```
hostname(config)# show running-config privilege level 10
privilege show level 10 command aaa
```

The following command displays the command assignment for the **access-list** command:

```
hostname(config)# show running-config privilege command access-list
privilege show level 15 command access-list
privilege clear level 15 command access-list
privilege configure level 15 command access-list
```



## Configuring TACACS+ Command Authorization

If you enable TACACS+ command authorization, and a user enters a command at the CLI, the security appliance sends the command and username to the TACACS+ server to determine if the command is authorized.

When configuring command authorization with a TACACS+ server, do not save your configuration until you are sure it works the way you want. If you get locked out because of a mistake, you can usually recover access by restarting the security appliance. If you still get locked out, see the [“Recovering from a Lockout” section on page 31-15](#).

Be sure that your TACACS+ system is completely stable and reliable. The necessary level of reliability typically requires that you have a fully redundant TACACS+ server system and fully redundant connectivity to the security appliance. For example, in your TACACS+ server pool, include one server connected to interface 1, and another to interface 2. You can also configure local command authorization as a fallback method if the TACACS+ server is unavailable. In this case, you need to configure local users and command privilege levels according to the [“Configuring Command Authorization” section on page 31-7](#).

This section includes the following topics:

- [TACACS+ Command Authorization Prerequisites, page 31-11](#)
- [Configuring Commands on the TACACS+ Server, page 31-11](#)
- [Enabling TACACS+ Command Authorization, page 31-14](#)

### TACACS+ Command Authorization Prerequisites

Complete the following tasks as part of your command authorization configuration:

- Configure CLI authentication (see the [“Configuring Local Command Authorization” section on page 31-7](#)).
- Configure **enable** authentication (see the [“Configuring Authentication To Access Privileged EXEC Mode” section on page 31-5](#)).

### Configuring Commands on the TACACS+ Server

You can configure commands on a Cisco Secure Access Control Server (ACS) TACACS+ server as a shared profile component, for a group, or for individual users. For third-party TACACS+ servers, see your server documentation for more information about command authorization support.

See the following guidelines for configuring commands in Cisco Secure ACS Version 3.1; many of these guidelines also apply to third-party servers:

- The security appliance sends the commands to be authorized as “shell” commands, so configure the commands on the TACACS+ server as shell commands.



**Note** Cisco Secure ACS might include a command type called “pix-shell.” Do not use this type for security appliance command authorization.

- The first word of the command is considered to be the main command. All additional words are considered to be arguments, which need to be preceded by **permit** or **deny**.

For example, to allow the **show running-configuration aaa-server** command, add **show running-configuration** to the command box, and type **permit aaa-server** in the arguments box.

- You can permit all arguments of a command that you do not explicitly deny by selecting the **Permit Unmatched Args** check box.

For example, you can configure just the **show** command, and then all the **show** commands are allowed. We recommend using this method so that you do not have to anticipate every variant of a command, including abbreviations and **?**, which shows CLI usage (see [Figure 31-1](#)).

**Figure 31-1** Permitting All Related Commands

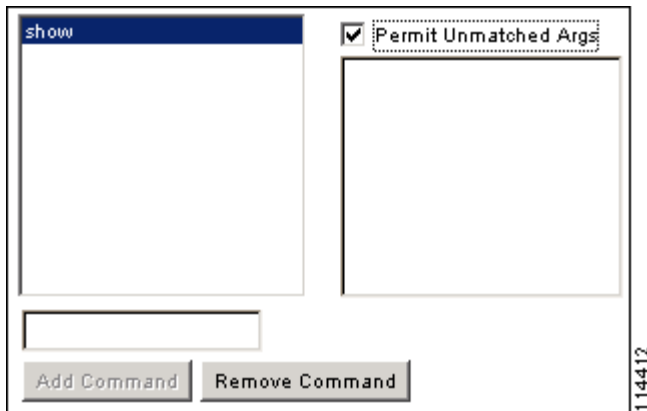

- For commands that are a single word, you *must* permit unmatched arguments, even if there are no arguments for the command, for example **enable** or **help** (see [Figure 31-2](#)).

**Figure 31-2** Permitting Single Word Commands

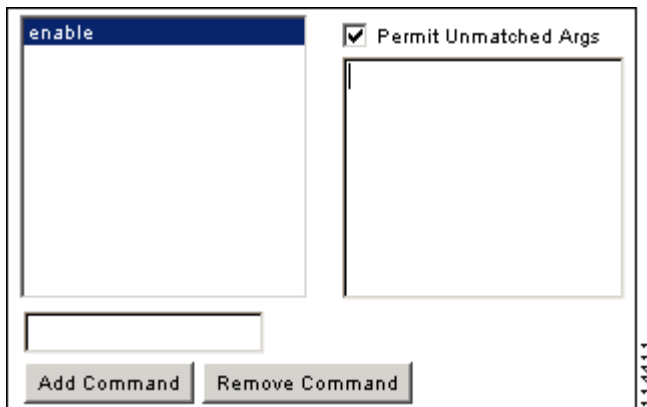

- To disallow some arguments, enter the arguments preceded by **deny**. For example, to allow **enable**, but not **enable password**, enter **enable** in the commands box, and **deny password** in the arguments box. Be sure to select the Permit Unmatched Args check box so that **enable** alone is still allowed (see [Figure 31-3](#)).

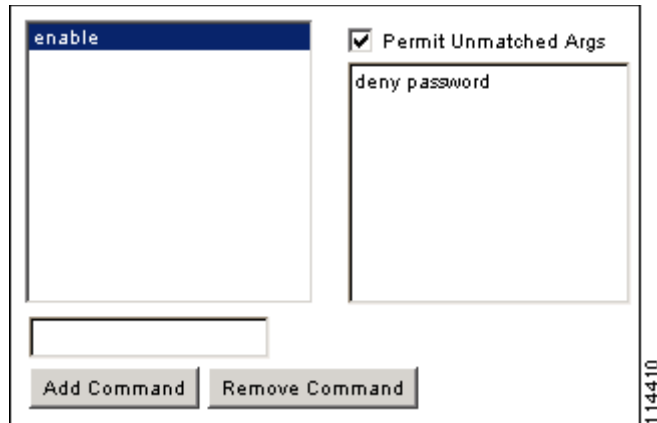
**Figure 31-3** Disallowing Arguments

- When you abbreviate a command at the command line, the security appliance expands the prefix and main command to the full text, but it sends additional arguments to the TACACS+ server as you enter them.

For example, if you enter **sh log**, then the security appliance sends the entire command to the TACACS+ server, **show logging**. However, if you enter **sh log mess**, then the security appliance sends **show logging mess** to the TACACS+ server, and not the expanded command **show logging message**. You can configure multiple spellings of the same argument to anticipate abbreviations (see [Figure 31-4](#)).

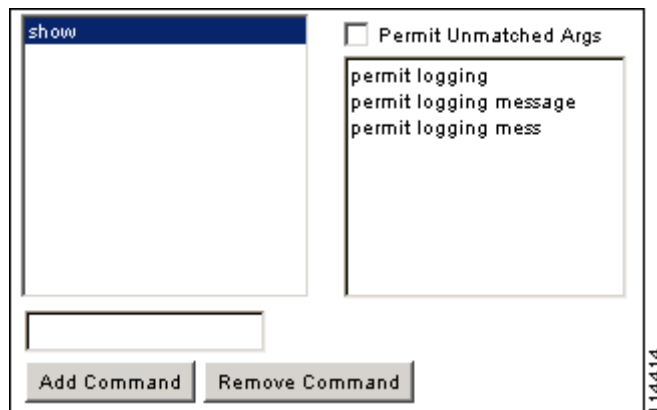
**Figure 31-4** Specifying Abbreviations

- We recommend that you allow the following basic commands for all users:
  - **show checksum**
  - **show curpriv**
  - **enable**
  - **help**
  - **show history**
  - **login**
  - **logout**
  - **pager**

- **show pager**
- **clear pager**
- **quit**
- **show version**

## Enabling TACACS+ Command Authorization

Before you enable TACACS+ command authorization, be sure that you are logged into the security appliance as a user that is defined on the TACACS+ server, and that you have the necessary command authorization to continue configuring the security appliance. For example, you should log in as an admin user with all commands authorized. Otherwise, you could become unintentionally locked out.

To perform command authorization using a TACACS+ server, enter the following command:

```
hostname(config)# aaa authorization command tacacs+_server_group [LOCAL]
```

You can configure the security appliance to use the local database as a fallback method if the TACACS+ server is unavailable. To enable fallback, specify the server group name followed by **LOCAL** (**LOCAL** is case sensitive). We recommend that you use the same username and password in the local database as the TACACS+ server because the security appliance prompt does not give any indication which method is being used. Be sure to configure users in the local database (see the “[Configuring Command Authorization](#)” section on page 31-7) and command privilege levels (see the “[Configuring Local Command Authorization](#)” section on page 31-7).

## Viewing the Current Logged-In User

To view the current logged-in user, enter the following command:

```
hostname# show curpriv
```

See the following sample **show curpriv** command output. A description of each field follows.

```
hostname# show curpriv
Username : admin
Current privilege level : 15
Current Mode/s : P_PRIV
```

[Table 31-1](#) describes the **show curpriv** command output.

**Table 31-1** *show curpriv Display Description*

| Field                   | Description                                                                                                                                                                                                     |
|-------------------------|-----------------------------------------------------------------------------------------------------------------------------------------------------------------------------------------------------------------|
| Username                | Username. If you are logged in as the default user, the name is enable_1 (user EXEC) or enable_15 (privileged EXEC).                                                                                            |
| Current privilege level | Level from 0 to 15. Unless you configure local command authorization and assign commands to intermediate privilege levels, levels 0 and 15 are the only levels that are used.                                   |
| Current Mode/s          | Shows the access modes: <ul style="list-style-type: none"> <li>• P_UNPR—User EXEC mode (levels 0 and 1)</li> <li>• P_PRIV—Privileged EXEC mode (levels 2 to 15)</li> <li>• P_CONF—Configuration mode</li> </ul> |

## Recovering from a Lockout

In some circumstances, when you turn on command authorization or CLI authentication, you can be locked out of the security appliance CLI. You can usually recover access by restarting the security appliance. However, if you already saved your configuration, you might be locked out. [Table 31-2](#) lists the common lockout conditions and how you might recover from them.

**Table 31-2** CLI Authentication and Command Authorization Lockout Scenarios

| Feature                                                                                  | Lockout Condition                                                                      | Description                                                                                   | Workaround: Single Mode                                                                                                                                                                                                                                   | Workaround: Multiple Mode                                                                                                                                                                                                                                                                                                                                                                                                                  |
|------------------------------------------------------------------------------------------|----------------------------------------------------------------------------------------|-----------------------------------------------------------------------------------------------|-----------------------------------------------------------------------------------------------------------------------------------------------------------------------------------------------------------------------------------------------------------|--------------------------------------------------------------------------------------------------------------------------------------------------------------------------------------------------------------------------------------------------------------------------------------------------------------------------------------------------------------------------------------------------------------------------------------------|
| Local CLI authentication                                                                 | No users in the local database                                                         | If you have no users in the local database, you cannot log in, and you cannot add any users.  | Log in and reset the passwords and <b>aaa</b> commands.                                                                                                                                                                                                   | Session into the security appliance from the switch. From the system execution space, you can change to the context and add a user.                                                                                                                                                                                                                                                                                                        |
| TACACS+ command authorization<br>TACACS+ CLI authentication<br>RADIUS CLI authentication | Server down or unreachable and you do not have the fallback method configured          | If the server is unreachable, then you cannot log in or enter any commands.                   | <ol style="list-style-type: none"> <li>1. Log in and reset the passwords and AAA commands.</li> <li>2. Configure the local database as a fallback method so you do not get locked out when the server is down.</li> </ol>                                 | <ol style="list-style-type: none"> <li>1. If the server is unreachable because the network configuration is incorrect on the security appliance, session into the security appliance from the switch. From the system execution space, you can change to the context and reconfigure your network settings.</li> <li>2. Configure the local database as a fallback method so you do not get locked out when the server is down.</li> </ol> |
| TACACS+ command authorization                                                            | You are logged in as a user without enough privileges or as a user that does not exist | You enable command authorization, but then find that the user cannot enter any more commands. | <p>Fix the TACACS+ server user account.</p> <p>If you do not have access to the TACACS+ server and you need to configure the security appliance immediately, then log into the maintenance partition and reset the passwords and <b>aaa</b> commands.</p> | Session into the security appliance from the switch. From the system execution space, you can change to the context and complete the configuration changes. You can also disable command authorization until you fix the TACACS+ configuration.                                                                                                                                                                                            |
| Local command authorization                                                              | You are logged in as a user without enough privileges                                  | You enable command authorization, but then find that the user cannot enter any more commands. | Log in and reset the passwords and <b>aaa</b> commands.                                                                                                                                                                                                   | Session into the security appliance from the switch. From the system execution space, you can change to the context and change the user level.                                                                                                                                                                                                                                                                                             |

## Configuring a Login Banner

You can configure a message to display when a user connects to the security appliance, before a user logs in, or before a user enters privileged EXEC mode.

To configure a login banner, enter the following command in the system execution space or within a context:

```
hostname(config)# banner {exec | login | motd} text
```

Adds a banner to display at one of three times: when a user first connects (message-of-the-day (**motd**)), when a user logs in (**login**), and when a user accesses privileged EXEC mode (**exec**). When a user connects to the security appliance, the message-of-the-day banner appears first, followed by the login banner and prompts. After the user successfully logs in to the security appliance, the exec banner displays.

For the banner text, spaces are allowed but tabs cannot be entered using the CLI. You can dynamically add the hostname or domain name of the security appliance by including the strings **\$(hostname)** and **\$(domain)**. If you configure a banner in the system configuration, you can use that banner text within a context by using the **\$(system)** string in the context configuration.

To add more than one line, precede each line by the **banner** command.

For example, to add a message-of-the-day banner, enter:

```
hostname(config)# banner motd Welcome to $(hostname).
hostname(config)# banner motd Contact me at admin@example.com for any
hostname(config)# banner motd issues.
```



# Managing Software, Licenses, and Configurations

---

This chapter contains information about managing the security appliance software, licenses, and configurations, and includes the following sections:

- [Managing Licenses, page 32-1](#)
- [Viewing Files in Flash Memory, page 32-2](#)
- [Retrieving Files from Flash Memory, page 32-3](#)
- [Downloading Files to Flash Memory from a Server, page 32-3](#)
- [Configuring the Application Image and ASDM Image to Boot, page 32-5](#)
- [Performing Zero Downtime Upgrades for Failover Pairs, page 32-5](#)
- [Downloading and Backing Up Configuration Files, page 32-7](#)
- [Configuring Auto Update Support, page 32-11](#)

## Managing Licenses

When you install the software, the existing activation key is extracted from the original image and stored in a file in the security appliance file system.

## Obtaining an Activation Key

To obtain an activation key, you will need a Product Authorization Key, which you can purchase from your Cisco account representative. After obtaining the Product Authorization Key, register it on the Web to obtain an activation key by performing the following steps:

---

**Step 1** Obtain the serial number for your security appliance by entering the following command:

```
hostname> show version | include Number
```

Enter the pipe character (|) as part of the command.

**Step 2** Connect a web browser to one of the following websites (the URLs are case-sensitive):

Use the following website if you are a registered user of Cisco.com:

`http://www.cisco.com/go/license`

Use the following website if you are not a registered user of Cisco.com:

`http://www.cisco.com/go/license/public`

**Step 3** Enter the following information, when prompted:

- Your Product Authorization Key.
- The serial number of your security appliance.
- Your email address.

The activation key will be automatically generated and sent to the email address that you provide.

## Entering a New Activation Key

To enter the activation key, enter the following command:

```
hostname(config)# activation-key key
```

The key is a four or five-element hexadecimal string with one space between each element. For example, a key in the correct form might look like the following key:

```
0xe02888da 0x4ba7bed6 0xf1c123ae 0xffd8624e
```

The leading 0x specifier is optional; all values are assumed to be hexadecimal.

If you are already in multiple context mode, enter this command in the system execution space.

Before entering the activation key, ensure that the image in Flash memory and the running image are the same. You can do this by rebooting the security appliance before entering the new activation key.



### Note

The activation key is not stored in your configuration file. The key is tied to the serial number of the device.

You must reboot the security appliance after entering the new activation key for the change to take effect in the running image.

This example shows how to change the activation key on the security appliance:

```
hostname(config)# activation-key 0xe02888da 0x4ba7bed6 0xf1c123ae 0xffd8624e
```

## Viewing Files in Flash Memory

You can view files in Flash memory and see information about the files.

- To view the files in Flash memory, enter the following command:

```
hostname# dir [flash: | disk0: | disk1:]
```

The **flash:** keyword represents the internal Flash memory on the PIX 500 series security appliance. You can enter **flash:** or **disk0:** for the internal Flash memory on the ASA 5500 series adaptive security appliance. The **disk1:** keyword represents the external Flash memory on the ASA. The internal Flash memory is the default.



For example:

```
hostname# dir

Directory of disk0:/
500 -rw- 4958208 22:56:20 Nov 29 2004 cdisk.bin
2513 -rw- 4634 19:32:48 Sep 17 2004 first-backup
2788 -rw- 21601 20:51:46 Nov 23 2004 backup.cfg
2927 -rw- 8670632 20:42:48 Dec 08 2004 asdmfile.bin
```

- To view extended information about a specific file, enter the following command:

```
hostname# show file information [path:/] filename
```

The default path is the root directory of the internal Flash memory (flash:/ or disk0:/).

For example:

```
hostname# show file information cdisk.bin

disk0:/cdisk.bin:
 type is image (XXX) []
 file size is 4976640 bytes version 7.0(1)
```

The file size listed is for example only.

## Retrieving Files from Flash Memory

You can retrieve files directly from the Flash disk by using an HTTPS connection with the following URL, in which you supply values for the ASA IP address and the filename:

```
https://ASA_IP/disk0/filename
```

This option is useful for customers who wish to do the following:

- Copy from the ASA binary image (as a backup).
- Copy from WebVPN capture files.
- Copy any other Flash files to a secure desktop.

## Downloading Files to Flash Memory from a Server

You can download application images, ASDM images, and configuration files to the internal Flash memory or, for the ASA 5500 series adaptive security appliance, to the external Flash memory from a TFTP, FTP, HTTP, or HTTPS server.

To copy configuration files to the startup or running configuration, see the [“Downloading and Backing Up Configuration Files” section on page 32-7](#).

To configure the security appliance to use a specific application image or ASDM image if you have more than one installed, or have installed them in external Flash memory see the [“Configuring the Application Image and ASDM Image to Boot” section on page 32-5](#).

This section includes the following topics:

- [“Ensure Network Access to the Server” section on page 32-4](#)
- [“Downloading Files” section on page 32-4](#)

## Ensure Network Access to the Server

Make sure you have network access to the server:

- For single context mode, configure any interface, its IP address, and any static routes required to reach the server. See the “Configuring Interfaces” section on page 28-2 and then Chapter 8, “Configuring IP Routing and DHCP Services.”
- For multiple context mode, you must first add the admin context and configure interfaces, IP addresses, and routing to provide network access. See the “Configuring a Security Context” section on page 5-1, and then the “Configuring Interfaces” section on page 28-2 and Chapter 8, “Configuring IP Routing and DHCP Services.”

To check connectivity, use the **ping** command.

## Downloading Files

For multiple context mode, you must be in the system execution space.

To download a file to Flash memory, see the following commands for each download server type:

- To copy from a TFTP server, enter the following command:

```
hostname# copy tftp://server[/path]/filename {flash:/ | disk0:/ |
disk1:/}[path/]filename
```

The **flash:/** keyword represents the internal Flash memory on the PIX 500 series security appliance. You can enter **flash:/** or **disk0:/** for the internal Flash memory on the ASA 5500 series adaptive security appliance. The **disk1:/** keyword represents the external Flash memory on the ASA.

- To copy from an FTP server, enter the following command:

```
hostname# copy ftp://[user[:password]@]server[/path]/filename[;type=xx] {flash:/ |
disk0:/ | disk1:/}[path/]filename
```

The **type** can be one of the following keywords:

- **ap**—ASCII passive mode
- **an**—ASCII normal mode
- **ip**—(Default) Binary passive mode
- **in**—Binary normal mode

Use binary for image files.

- To copy from an HTTP or HTTPS server, enter the following command:

```
hostname# copy http[s]://
[user[:password]@]server[:port][/path]/filename {flash:/ | disk0:/ |
disk1:/}[path/]filename
```

- To use secure copy, first enable SSH, then enter the following command:

```
hostname# ssh scopy enable
```

Then from a Linux client enter the following command:

```
scp -v -pw password filename username@asa_address
```

The **-v** is for verbose, and if **-pw** is not specified you will be prompted for a password.

## Configuring the Application Image and ASDM Image to Boot

By default, the security appliance boots the first application image it finds in internal Flash memory. It also boots the first ASDM image it finds in internal Flash memory, or if none exists there, then in external Flash memory. If you have more than one image, you should specify the image you want to boot. In the case of the ASDM image, if you do not specify the image to boot, even if you have only one image installed, then the security appliance inserts the **asdm image** command into the running configuration. To avoid problems with Auto Update (if configured), and to avoid the image search at each startup, you should specify the ASDM image you want to boot in the startup configuration.

- To configure the application image to boot, enter the following command:

```
hostname(config)# boot system url
```

where *url* is one of the following:

- **{flash:/ | disk0:/ | disk1:/}***[path/]filename*

The **flash:/** keyword represents the internal Flash memory on the PIX 500 series security appliance. You can enter **flash:/** or **disk0:/** for the internal Flash memory on the ASA 5500 series adaptive security appliance. The **disk1:/** keyword represents the external Flash memory on the ASA.

- **tftp://[user[:password]@]server[:port]/[path/]filename**

This option is only supported for the ASA 5500 series adaptive security appliance.

You can enter up to four **boot system** command entries, to specify different images to boot from in order; the security appliance boots the first image it finds. Only one **boot system tftp:** command can be configured, and it must be the first one configured.

- To configure the ASDM image to boot, enter the following command:

```
hostname(config)# asdm image {flash:/ | disk0:/ | disk1:/} [path/] filename
```

## Performing Zero Downtime Upgrades for Failover Pairs

The two units in a failover configuration should have the same major (first number) and minor (second number) software version. However, you do not need to maintain version parity on the units during the upgrade process; you can have different versions on the software running on each unit and still maintain failover support. To ensure long-term compatibility and stability, we recommend upgrading both units to the same version as soon as possible.

[Table 32-1](#) shows the supported scenarios for performing zero-downtime upgrades on a failover pair.

**Table 32-1 Zero-Downtime Upgrade Support**

| Type of Upgrade     | Support                                                                                                                                                                                                                                                          |
|---------------------|------------------------------------------------------------------------------------------------------------------------------------------------------------------------------------------------------------------------------------------------------------------|
| Maintenance Release | You can upgrade from any maintenance release to any other maintenance release within a minor release.<br>For example, you can upgrade from 7.0(1) to 7.0(4) without first installing the maintenance releases in between.                                        |
| Minor Release       | You can upgrade from a minor release to the next minor release. You cannot skip a minor release.<br>For example, you can upgrade from 7.0 to 7.1. Upgrading from 7.0 directly to 7.2 is not supported for zero-downtime upgrades; you must first upgrade to 7.1. |
| Major Release       | You can upgrade from the last minor release of the previous version to the next major release.<br>For example, you can upgrade from 7.9 to 8.0, assuming that 7.9 is the last minor version in the 7.x release.                                                  |

For more details about upgrading the software on a failover pair, refer to the following topics:

- [Upgrading an Active/Standby Failover Configuration, page 32-6](#)
- [Upgrading and Active/Active Failover Configuration, page 32-7](#)

## Upgrading an Active/Standby Failover Configuration

To upgrade two units in an Active/Standby failover configuration, perform the following steps:

- 
- Step 1** Download the new software to both units, and specify the new image to load with the **boot system** command (see the “[Configuring the Application Image and ASDM Image to Boot](#)” section on [page 32-5](#)).
- Step 2** Reload the standby unit to boot the new image by entering the following command on the active unit:
- ```
active# failover reload-standby
```
- Step 3** When the standby unit has finished reloading, and is in the Standby Ready state, force the active unit to fail over to the standby unit by entering the following command on the active unit.



Note Use the **show failover** command to verify that the standby unit is in the Standby Ready state.

```
active# no failover active
```

- Step 4** Reload the former active unit (now the new standby unit) by entering the following command:
- ```
newstandby# reload
```

- Step 5** When the new standby unit has finished reloading, and is in the Standby Ready state, return the original active unit to active status by entering the following command:

```
newstandby# failover active
```

---

## Upgrading and Active/Active Failover Configuration

To upgrade two units in an Active/Active failover configuration, perform the following steps:

- Step 1** Download the new software to both units, and specify the new image to load with the **boot system** command (see the “[Configuring the Application Image and ASDM Image to Boot](#)” section on [page 32-5](#)).
- Step 2** Make both failover groups active on the primary unit by entering the following command in the system execution space of the primary unit:
- Step 3** Reload the secondary unit to boot the new image by entering the following command in the system execution space of the primary unit:
- Step 4** When the secondary unit has finished reloading, and both failover groups are in the Standby Ready state on that unit, make both failover groups active on the secondary unit using the following command in the system execution space of the primary unit:



**Note** Use the **show failover** command to verify that both failover groups are in the Standby Ready state on the secondary unit.

---

```
primary# no failover active
```

- Step 5** Make sure both failover groups are in the Standby Ready state on the primary unit, and then reload the primary unit using the following command:
- Step 6** If the failover groups are configured with the **preempt** command, they will automatically become active on their designated unit after the preempt delay has passed. If the failover groups are not configured with the **preempt** command, you can return them to active status on their designated units using the **failover active group** command.
- 

## Downloading and Backing Up Configuration Files

This section describes how to download and back up the startup and running configuration files, and also how to back up context configuration files. This section includes the following topics:

- [Downloading a Text File to the Startup or Running Configuration, page 32-8](#)
- [Configuring the File to Boot as the Startup Configuration, page 32-9](#)

- [Copying the Startup Configuration to the Running Configuration, page 32-9](#)
- [Backing Up the Configuration, page 32-9](#)

## Downloading a Text File to the Startup or Running Configuration

You can download a text file from the following server types:

- TFTP
- FTP
- HTTP
- HTTPS

Make sure you have network access to the server:

- For single context mode, configure any interface, its IP address, and any static routes required to reach the server. See the [“Configuring Interfaces” section on page 28-2](#) and then [Chapter 8, “Configuring IP Routing and DHCP Services.”](#)
- For multiple context mode, add the admin context and configure interfaces, IP addresses, and routing to provide network access. See the [“Configuring a Security Context” section on page 5-1](#), and then the [“Configuring Interfaces” section on page 28-2](#) and [Chapter 8, “Configuring IP Routing and DHCP Services.”](#)

To check connectivity, use the **ping** command.

To copy the startup configuration or running configuration from the server to the security appliance, enter one of the following commands for the appropriate download server.



### Note

When you copy a configuration to the running configuration, you merge the two configurations. A merge adds any new commands from the new configuration to the running configuration. If the configurations are the same, no changes occur. If commands conflict or if commands affect the running of the context, then the effect of the merge depends on the command. You might get errors, or you might have unexpected results.

- To copy from a TFTP server, enter the following command:

```
hostname# copy tftp://server[/path]/filename {startup-config | running-config}
```

- To copy from an FTP server, enter the following command:

```
hostname# copy ftp://[user[:password]@]server[/path]/filename[;type=xx]
{startup-config | running-config}
```

The **type** can be one of the following keywords:

- **ap**—ASCII passive mode
- **an**—ASCII normal mode
- **ip**—(Default) Binary passive mode
- **in**—Binary normal mode

You can use ASCII or binary for configuration files.

- To copy from an HTTP or HTTPS server, enter the following command:

```
hostname# copy http[s]://[user[:password]@]server[:port][/path]/filename
{startup-config | running-config}
```

For example, to copy the configuration from a TFTP server, enter the following command:

```
hostname# copy tftp://209.165.200.226/configs/startup.cfg startup-config
```

To copy the configuration from an FTP server, enter the following command:

```
hostname# copy ftp://admin:letmein@209.165.200.227/configs/startup.cfg?type=an
startup-config
```

To copy the configuration from an HTTP server, enter the following command:

```
hostname# copy http://209.165.200.228/configs/startup.cfg startup-config
```

## Configuring the File to Boot as the Startup Configuration

By default, the security appliance boots from a startup configuration that is a hidden file. You can alternatively set any configuration to be the startup configuration by entering the following command:

```
hostname(config)# boot config {flash:/ | disk0:/ | disk1:/} [path/] filename
```

The **flash:/** keyword represents the internal Flash memory on the PIX 500 series security appliance. You can enter **flash:/** or **disk0:/** for the internal Flash memory on the ASA 5500 series adaptive security appliance. The **disk1:/** keyword represents the external Flash memory on the ASA.

## Copying the Startup Configuration to the Running Configuration

Copy a new startup configuration to the running configuration using one of these options:

- To merge the startup configuration with the current running configuration, enter the following command:

```
hostname(config)# copy startup-config running-config
```

- To load the startup configuration and discard the running configuration, restart the security appliance by entering the following command:

```
hostname# reload
```

Alternatively, you can use the following commands to load the startup configuration and discard the running configuration without requiring a reboot:

```
hostname/contexta(config)# clear configure all
hostname/contexta(config)# copy startup-config running-config
```

## Backing Up the Configuration

To back up your configuration, copy it to an external server. Use one of the following methods:

- [Backing up the Single Mode or Multiple Mode System Configuration, page 32-10](#)
- [Backing up a Context Configuration within the Context, page 32-10](#)
- [Copying the Configuration from the Terminal Display, page 32-10](#)

## Backing up the Single Mode or Multiple Mode System Configuration

In single context mode, or from the system configuration in multiple mode, you can copy the startup configuration, running configuration, or any configuration file in Flash memory.

Enter one of the following commands for the appropriate backup server:

- To copy to a TFTP server, enter the following command:

```
hostname# copy {startup-config | running-config | flashmem:[path/]filename}
tftp://server[/path]/filename
```

where *flashmem* is **flash**, **disk0**, or **disk1**. The **flash** keyword represents the internal Flash memory on the PIX 500 series security appliance. You can enter **flash** or **disk0** for the internal Flash memory on the ASA 5500 series adaptive security appliance. The **disk1** keyword represents the external Flash memory on the ASA.

- To copy to an FTP server, enter the following command:

```
hostname# copy {startup-config | running-config | flashmem:[path/]filename}
ftp://[user[:password]@]server[/path]/filename[;type=xx]
```

The **type** can be one of the following keywords:

- **ap**—ASCII passive mode
- **an**—ASCII normal mode
- **ip**—(Default) Binary passive mode
- **in**—Binary normal mode

Use ASCII or binary for configuration files (as in this case), and binary only for image files.

## Backing up a Context Configuration within the Context

In multiple context mode, from within a context, you can perform the following backups:

- To copy the running configuration to the startup configuration server (connected to the admin context), enter the following command:

```
hostname/contexta# copy running-config startup-config
```

- To copy the running configuration to a TFTP server connected to the context network, enter the following command:

```
hostname/contexta# copy running-config tftp://server[/path]/filename
```

## Copying the Configuration from the Terminal Display

To print the configuration to the terminal, enter the following command:

```
hostname# show running-config
```

Copy the output from this command, then paste the configuration into a text file.



# Configuring Auto Update Support

Auto Update is a protocol specification that allows an Auto Update Server to download configurations and software images to a many security appliances, and can provide basic monitoring of the security appliances from a central location. The security appliance periodically polls the Auto Update Server for updates to software images and configuration files.



## Note

Auto Update is supported in single context mode only.

This section includes the following topics:

- [Configuring Communication with an Auto Update Server, page 32-11](#)
- [Viewing Auto Update Status, page 32-12](#)

## Configuring Communication with an Auto Update Server

To configure Auto Update, perform the following steps:

**Step 1** To specify the URL of the AUS, use the following command:

```
hostname(config)# auto-update server url [source interface] [verify-certificate]
```

Where *url* has the following syntax:

```
http[s]://[user:password@]server_ip[:port]/pathname
```

You can configure only one server. SSL is used when **https** is specified. The *user* and *password* arguments of the URL are used for Basic Authentication when logging in to the server. If you use the **write terminal**, **show configuration** or **show tech-support** commands to view the configuration, the user and password are replaced with '\*\*\*\*\*'.

The default port is 80 for HTTP and 443 for HTTPS.

The **source interface** argument specifies which interface to use when sending requests to the AUS. If you specify the same interface specified by the **management-access** command, the Auto Update requests travel over the same IPsec VPN tunnel used for management access.

The **verify-certificate** keyword verifies the certificate returned by the AUS.

**Step 2** (Optional) To identify the device ID to send when communicating with the AUS, enter the following command:

```
hostname(config)# auto-update device-id {hardware-serial | hostname | ipaddress [if-name]
| mac-address [if-name] | string text}
```

The identifier used is determined by using one of the following parameters:

- **hardware-serial**—Use the security appliance serial number.
- **hostname**—Use the security appliance hostname.
- **ipaddress**—Use the IP address of the specified interface. If the interface name is not specified, it uses the IP address of the interface used to communicate with the AUS.
- **mac-address**—Use the MAC address of the specified interface. If the interface name is not specified, it uses the MAC address of the interface used to communicate with the AUS.

- **string**—Use the specified text identifier, which cannot contain white space or the characters ‘, “, , >, & and ?.

**Step 3** (Optional) To specify how often to poll the AUS for configuration or image updates, enter the following command:

```
hostname(config)# auto-update poll-period poll-period [retry-count [retry-period]]
```

The *poll-period* argument specifies how often (in minutes) to check for an update. The default is 720 minutes (12 hours).

The *retry-count* argument specifies how many times to try reconnecting to the server if the first attempt fails. The default is 0.

The *retry-period* argument specifies how long to wait (in minutes) between retries. The default is 5.

**Step 4** (Optional) If the Auto Update Server has not been contacted for a certain period of time, the following command will cause it to cease passing traffic:

```
hostname(config)# auto-update timeout period
```

Where *period* specifies the timeout period in minutes between 1 and 35791. The default is to never time out (0). To restore the default, enter the **no** form of this command.

Use this command to ensure that the security appliance has the most recent image and configuration. This condition is reported with system log message 201008.

In the following example, a security appliance is configured to poll an AUS with IP address 209.165.200.224, at port number 1742, from the outside interface, with certificate verification.

It is also configured to use the hostname of the security appliance as the device ID, and the polling period has been decreased from the default of 720 minutes to 600 minutes. On a failed polling attempt, it will try to reconnect to the AUS 10 times, and wait 3 minutes between attempts at reconnecting.

```
hostname(config)# auto-update server
https://jcrichon:farscape@209.165.200.224:1742/management source outside
verify-certificate
hostname(config)# auto-update device-id hostname
hostname(config)# auto-update poll-period 600 10 3
```

## Viewing Auto Update Status

To view the Auto Update status, enter the following command:

```
hostname(config)# show auto-update
```

The following is sample output from the **show auto-update** command:

```
hostname(config)# show auto-update
Server: https://*****@209.165.200.224:1742/management.cgi?1276
Certificate will be verified
Poll period: 720 minutes, retry count: 2, retry period: 5 minutes
Timeout: none
Device ID: host name [corporate]
Next poll in 4.93 minutes
Last poll: 11:36:46 PST Tue Nov 13 2004
Last PDM update: 23:36:46 PST Tue Nov 12 2004
```



## Monitoring and Troubleshooting

---

This chapter describes how to monitor and troubleshoot the security appliance, and includes the following sections:

- [Monitoring the Security Appliance, page 33-1](#)
- [Troubleshooting the Security Appliance, page 33-4](#)

### Monitoring the Security Appliance

This section describes how to monitor the security appliance, and includes the following topics:

- [Using System Log Messages, page 33-1](#)
- [Using SNMP, page 33-1](#)

### Using System Log Messages

The security appliance provides extensive system log messages. See the *Cisco Security Appliance Logging Configuration and System Log Messages* to configure logging and to view system log message descriptions.

### Using SNMP

This section describes how to use SNMP and includes the following topics:

- [SNMP Overview, page 33-1](#)
- [Enabling SNMP, page 33-3](#)

### SNMP Overview

The security appliance provides support for network monitoring using SNMP V1 and V2c. The security appliance supports traps and SNMP read access, but does not support SNMP write access.

You can configure the security appliance to send traps (event notifications) to a network management station (NMS), or you can use the NMS to browse the MIBs on the security appliance. MIBs are a collection of definitions, and the security appliance maintains a database of values for each definition. Browsing a MIB entails issuing an SNMP get request from the NMS. Use CiscoWorks for Windows or any other SNMP V1, MIB-II compliant browser to receive SNMP traps and browse a MIB.

Table 33-1 lists supported MIBs and traps for the security appliance and, in multiple mode, for each context. You can download Cisco MIBs from the following website.

<http://www.cisco.com/public/sw-center/netmgmt/cmtk/mibs.shtml>

After you download the MIBs, compile them for your NMS.

**Table 33-1** SNMP MIB and Trap Support

| MIB or Trap Support             | Description                                                                                                                                                                                                                                                                                                                                                                                                                                                             |
|---------------------------------|-------------------------------------------------------------------------------------------------------------------------------------------------------------------------------------------------------------------------------------------------------------------------------------------------------------------------------------------------------------------------------------------------------------------------------------------------------------------------|
| SNMP core traps                 | The security appliance sends the following core SNMP traps: <ul style="list-style-type: none"> <li>• authentication—An SNMP request fails because the NMS did not authenticate with the correct community string.</li> <li>• linkup—An interface has transitioned to the “up” state.</li> <li>• linkdown—An interface is down, for example, if you removed the <b>nameif</b> command.</li> <li>• coldstart—The security appliance is running after a reload.</li> </ul> |
| MIB-II                          | The security appliance supports browsing of the following groups and tables: <ul style="list-style-type: none"> <li>• system</li> </ul>                                                                                                                                                                                                                                                                                                                                 |
| IF-MIB                          | The security appliance supports browsing of the following tables: <ul style="list-style-type: none"> <li>• ifTable</li> <li>• ifXTable</li> </ul>                                                                                                                                                                                                                                                                                                                       |
| RFC1213-MIB                     | The security appliance supports browsing of the following table: <ul style="list-style-type: none"> <li>• ip.ipAddrTable</li> </ul>                                                                                                                                                                                                                                                                                                                                     |
| SNMPv2-MIB                      | The security appliance supports browsing the following: <ul style="list-style-type: none"> <li>• snmp</li> </ul>                                                                                                                                                                                                                                                                                                                                                        |
| ENTITY-MIB                      | The security appliance supports browsing of the following groups and tables: <ul style="list-style-type: none"> <li>• entPhysicalTable</li> <li>• entLogicalTable</li> </ul> The security appliance supports browsing of the following traps: <ul style="list-style-type: none"> <li>• snmp-server enable traps entity {config-changelfru-insertlfu-remove}</li> </ul>                                                                                                  |
| CISCO-IPSEC-FLOW-MONITOR-MIB    | The security appliance supports browsing of the MIB.<br>The security appliance supports browsing of the following traps: <ul style="list-style-type: none"> <li>• snmp-server enable traps ipsec {startlstop}</li> </ul>                                                                                                                                                                                                                                                |
| CISCO-REMOTE-ACCESS-MONITOR-MIB | The security appliance supports browsing of the MIB.<br>The security appliance supports browsing of the following traps: <ul style="list-style-type: none"> <li>• snmp-server enable traps remote-access {session-threshold-exceeded}</li> </ul>                                                                                                                                                                                                                        |
| CISCO-CRYPTO-ACCELERATOR-MIB    | The security appliance supports browsing of the MIB.                                                                                                                                                                                                                                                                                                                                                                                                                    |
| ALTIGA-GLOBAL-REG               | The security appliance supports browsing of the MIB.                                                                                                                                                                                                                                                                                                                                                                                                                    |

Table 33-1 SNMP MIB and Trap Support (continued)

| MIB or Trap Support   | Description                                                                                                                                                                                                                                                                           |
|-----------------------|---------------------------------------------------------------------------------------------------------------------------------------------------------------------------------------------------------------------------------------------------------------------------------------|
| Cisco Firewall MIB    | The security appliance supports browsing of the following groups: <ul style="list-style-type: none"> <li>cfwSystem<br/>The information is cfwSystem.cfwStatus, which relates to failover status, pertains to the entire device and not just a single context.</li> </ul>              |
| Cisco Memory Pool MIB | The security appliance supports browsing of the following table: <ul style="list-style-type: none"> <li>ciscoMemoryPoolTable—The memory usage described in this table applies only to the security appliance general-purpose processor, and not to the network processors.</li> </ul> |
| Cisco Process MIB     | The security appliance supports browsing of the following table: <ul style="list-style-type: none"> <li>cpmCPUTotalTable</li> </ul>                                                                                                                                                   |
| Cisco Syslog MIB      | The security appliance supports the following trap: <ul style="list-style-type: none"> <li>clogMessageGenerated</li> </ul> You cannot browse this MIB.                                                                                                                                |

## Enabling SNMP

The SNMP agent that runs on the security appliance performs two functions:

- Replies to SNMP requests from NMSs.
- Sends traps (event notifications) to NMSs.

To enable the SNMP agent and identify an NMS that can connect to the security appliance, follow these steps:

- 
- Step 1** To identify the IP address of the NMS that can connect to the security appliance, enter the following command:
- ```
hostname(config)# snmp-server host interface_name ip_address [trap | poll] [community text] [version 1 | 2c] [udp-port port]
```
- Specify **trap** or **poll** if you want to limit the NMS to receiving traps only or browsing (polling) only. By default, the NMS can use both functions.
- SNMP traps are sent on UDP port 162 by default. You can change the port number using the **udp-port** keyword.
- Step 2** To specify the community string, enter the following command:
- ```
hostname(config)# snmp-server community key
```
- The SNMP community string is a shared secret between the security appliance and the NMS. The key is a case-sensitive value up to 32 characters in length. Spaces are not permitted.
- Step 3** (Optional) To set the SNMP server location or contact information, enter the following command:
- ```
hostname(config)# snmp-server {contact | location} text
```
- Step 4** To enable the security appliance to send traps to the NMS, enter the following command:
- ```
hostname(config)# snmp-server enable [traps [all | feature [trap1] [trap2]] [...]]
```

By default, SNMP core traps are enabled (**snmp**). If you do not enter a trap type in the command, **syslog** is the default. To enable or disable all traps, enter the **all** option. For **snmp**, you can identify each trap type separately. See [Table 33-1 on page 33-2](#) for a list of traps.

**Step 5** To enable system messages to be sent as traps to the NMS, enter the following command:

```
hostname(config)# logging history level
```

You must also enable **syslog** traps using the preceding **snmp-server enable traps** command.

**Step 6** To enable logging, so system messages are generated and can then be sent to an NMS, enter the following command:

```
hostname(config)# logging on
```

---

The following example sets the security appliance to receive requests from host 192.168.3.2 on the inside interface.

```
hostname(config)# snmp-server host 192.168.3.2
hostname(config)# snmp-server location building 42
hostname(config)# snmp-server contact Pat lee
hostname(config)# snmp-server community ohwhatakeyisthee
```

## Troubleshooting the Security Appliance

This section describes how to troubleshoot the security appliance, and includes the following topics:

- [Testing Your Configuration, page 33-4](#)
- [Reloading the Security Appliance, page 33-9](#)
- [Performing Password Recovery, page 33-9](#)
- [Other Troubleshooting Tools, page 33-12](#)
- [Common Problems, page 33-13](#)

## Testing Your Configuration

This section describes how to test connectivity for the single mode security appliance or for each security context. The following steps describe how to ping the security appliance interfaces, and how to allow hosts on one interface to ping through to hosts on another interface.

We recommend that you only enable pinging and debug messages during troubleshooting. When you are done testing the security appliance, follow the steps in the [“Disabling the Test Configuration” section on page 33-8](#).

This section includes:

- [Enabling ICMP Debug Messages and System Messages, page 33-5](#)
- [Pinging Security Appliance Interfaces, page 33-5](#)
- [Pinging Through the Security Appliance, page 33-7](#)
- [Disabling the Test Configuration, page 33-8](#)

## Enabling ICMP Debug Messages and System Messages

Debug messages and system messages can help you troubleshoot why your pings are not successful. The security appliance only shows ICMP debug messages for pings to the security appliance interfaces, and not for pings through the security appliance to other hosts. To enable debugging and system messages, perform the following steps:

- Step 1** To show ICMP packet information for pings to the security appliance interfaces, enter the following command:

```
hostname(config)# debug icmp trace
```

- Step 2** To set system messages to be sent to Telnet or SSH sessions, enter the following command:

```
hostname(config)# logging monitor debug
```

You can alternately use **logging buffer debug** to send messages to a buffer, and then view them later using the **show logging** command.

- Step 3** To send the system messages to your Telnet or SSH session, enter the following command:

```
hostname(config)# terminal monitor
```

- Step 4** To enable system messages, enter the following command:

```
hostname(config)# logging on
```

The following example shows a successful ping from an external host (209.165.201.2) to the security appliance outside interface (209.165.201.1):

```
hostname(config)# debug icmp trace
Inbound ICMP echo reply (len 32 id 1 seq 256) 209.165.201.1 > 209.165.201.2
Outbound ICMP echo request (len 32 id 1 seq 512) 209.165.201.2 > 209.165.201.1
Inbound ICMP echo reply (len 32 id 1 seq 512) 209.165.201.1 > 209.165.201.2
Outbound ICMP echo request (len 32 id 1 seq 768) 209.165.201.2 > 209.165.201.1
Inbound ICMP echo reply (len 32 id 1 seq 768) 209.165.201.1 > 209.165.201.2
Outbound ICMP echo request (len 32 id 1 seq 1024) 209.165.201.2 > 209.165.201.1
Inbound ICMP echo reply (len 32 id 1 seq 1024) 209.165.201.1 > 209.165.201.2
```

The preceding example shows the ICMP packet length (32 bytes), the ICMP packet identifier (1), and the ICMP sequence number (the ICMP sequence number starts at 0 and is incremented each time a request is sent).

## Pinging Security Appliance Interfaces

To test that the security appliance interfaces are up and running and that the security appliance and connected routers are routing correctly, you can ping the security appliance interfaces.



### Note

For security purposes the security appliance does not support far-end interface ping, that is pinging the IP address of the outside interface from the inside network.

To ping the security appliance interfaces, perform the following steps:

- Step 1** Create a sketch of your single mode security appliance or security context showing the interface names, security levels, and IP addresses. The sketch should also include any directly connected routers, and a host on the other side of the router from which you will ping the security appliance. You will use this information for this procedure as well as the procedure in the “[Pinging Through the Security Appliance](#)” section on page 33-7. For example:

**Figure 33-1 Network Sketch with Interfaces, Routers, and Hosts**

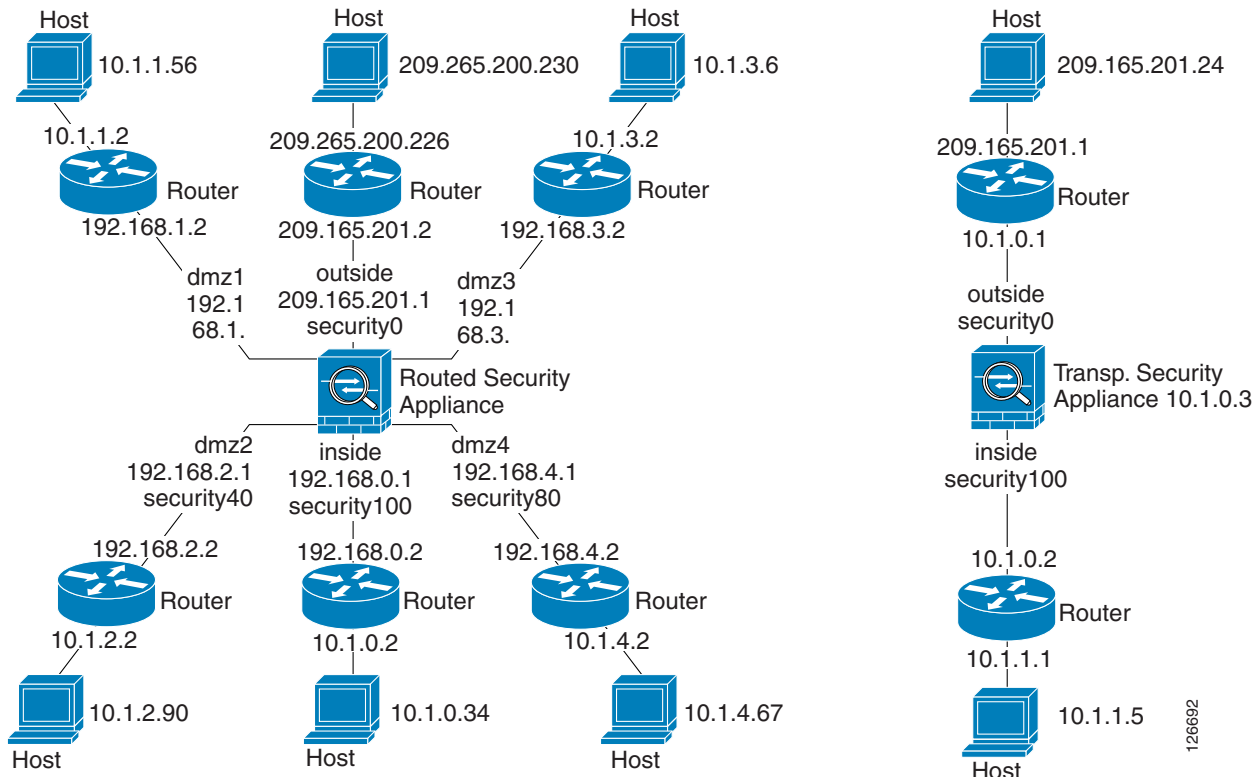

- Step 2** Ping each security appliance interface from the *directly connected* routers. For transparent mode, ping the management IP address.

This test ensures that the security appliance interfaces are active and that the interface configuration is correct.

A ping might fail if the security appliance interface is not active, the interface configuration is incorrect, or if a switch between the security appliance and router is down (see [Figure 33-2](#)). In this case, no debug messages or system messages appear on the security appliance, because the packet never reaches it.

**Figure 33-2 Ping Failure at Security Appliance Interface**

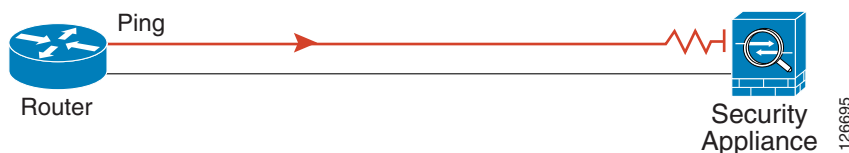



If the ping reaches the security appliance, and the security appliance responds, you see debug messages like the following:

```
ICMP echo reply (len 32 id 1 seq 256) 209.165.201.1 > 209.165.201.2
ICMP echo request (len 32 id 1 seq 512) 209.165.201.2 > 209.165.201.1
```

If the ping reply does not return to the router, then you might have a switch loop or redundant IP addresses (see [Figure 33-3](#)).

**Figure 33-3 Ping Failure Because of IP Addressing Problems**

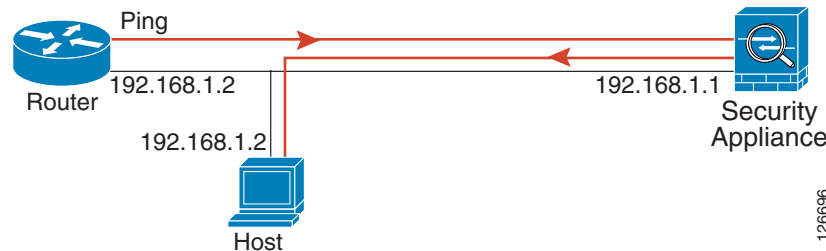

- Step 3** Ping each security appliance interface from a remote host. For transparent mode, ping the management IP address.

This test checks that the directly connected router can route the packet between the host and the security appliance, and that the security appliance can correctly route the packet back to the host.

A ping might fail if the security appliance does not have a route back to the host through the intermediate router (see [Figure 33-4](#)). In this case, the debug messages show that the ping was successful, but you see system message 110001 indicating a routing failure.

**Figure 33-4 Ping Failure Because the Security Appliance has no Route**

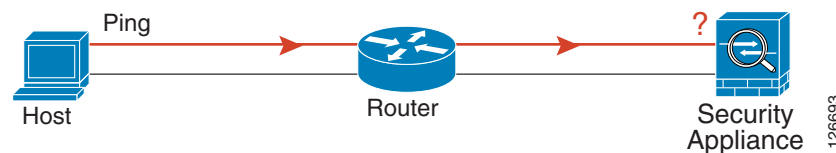

## Pinging Through the Security Appliance

After you successfully ping the security appliance interfaces, you should make sure traffic can pass successfully through the security appliance. For routed mode, this test shows that NAT is working correctly, if configured. For transparent mode, which does not use NAT, this test confirms that the security appliance is operating correctly; if the ping fails in transparent mode, contact Cisco TAC.

To ping between hosts on different interfaces, perform the following steps:

- Step 1** To add an access list allowing ICMP from any source host, enter the following command:

```
hostname(config)# access-list ICMPACL extended permit icmp any any
```

By default, when hosts access a lower security interface, all traffic is allowed through. However, to access a higher security interface, you need the preceding access list.

**Step 2** To assign the access list to each source interface, enter the following command:

```
hostname(config)# access-group ICMPACL in interface interface_name
```

Repeat this command for each source interface.

**Step 3** To enable the ICMP inspection engine, so ICMP responses are allowed back to the source host, enter the following commands:

```
hostname(config)# class-map ICMP-CLASS
hostname(config-cmap)# match access-list ICMPACL
hostname(config-cmap)# policy-map ICMP-POLICY
hostname(config-pmap)# class ICMP-CLASS
hostname(config-pmap-c)# inspect icmp
hostname(config-pmap-c)# service-policy ICMP-POLICY global
```

Alternatively, you can also apply the ICMPACL access list to the destination interface to allow ICMP traffic back through the security appliance.

**Step 4** Ping from the host or router through the source interface to another host or router on another interface.

Repeat this step for as many interface pairs as you want to check.

If the ping succeeds, you see a system message confirming the address translation for routed mode (305009 or 305011) and that an ICMP connection was established (302020). You can also enter the **show xlate** and **show conns** commands to view this information.

If the ping fails for transparent mode, contact Cisco TAC.

For routed mode, the ping might fail because NAT is not configured correctly (see [Figure 33-5](#)). This is more likely if you enable NAT control. In this case, you see a system message showing that the NAT translation failed (305005 or 305006). If the ping is from an outside host to an inside host, and you do not have a static translation (which is required with NAT control), you see message 106010: deny inbound icmp.



**Note**

The security appliance only shows ICMP debug messages for pings to the security appliance interfaces, and not for pings through the security appliance to other hosts.

**Figure 33-5 Ping Failure Because the Security Appliance is not Translating Addresses**



## Disabling the Test Configuration

After you complete your testing, disable the test configuration that allows ICMP to and through the security appliance and that prints debug messages. If you leave this configuration in place, it can pose a serious security risk. Debug messages also slow the security appliance performance.

To disable the test configuration, perform the following steps:

**Step 1** To disable ICMP debug messages, enter the following command:

```
hostname(config)# no debug icmp trace
```

**Step 2** To disable logging, if desired, enter the following command:

```
hostname(config)# no logging on
```

**Step 3** To remove the ICMPACL access list, and also delete the related **access-group** commands, enter the following command:

```
hostname(config)# no access-list ICMPACL
```

**Step 4** (Optional) To disable the ICMP inspection engine, enter the following command:

```
hostname(config)# no service-policy ICMP-POLICY
```

---

## Reloading the Security Appliance

In multiple mode, you can only reload from the system execution space. To reload the security appliance, enter the following command:

```
hostname# reload
```

## Performing Password Recovery

This section describes how to recover if you forget passwords, or you create a lockout situation because of AAA settings. You can also disable password recovery for extra security. This section includes the following topics:

- [Performing Password Recovery for the ASA 5500 Series Adaptive Security Appliance, page 33-9](#)
- [Password Recovery for the PIX 500 Series Security Appliance, page 33-11](#)
- [Disabling Password Recovery, page 33-12](#)

## Performing Password Recovery for the ASA 5500 Series Adaptive Security Appliance

To recover from the loss of passwords, perform the following steps:

---

**Step 1** Connect to the security appliance console port according to the [“Accessing the Command-Line Interface” section on page 2-1](#).

**Step 2** Power off the security appliance, and then power it on.

**Step 3** During the startup messages, press the **Escape** key when prompted to enter ROMMON.

**Step 4** To set the security appliance to ignore the startup configuration at reload, enter the following command:

```
rommon #1> confreg
```

The security appliance displays the current configuration register value, and asks if you want to change the value:

```
Current Configuration Register: 0x00000011
Configuration Summary:
 boot TFTP image, boot default image from Flash on netboot failure
```

Do you wish to change this configuration? y/n [n]:

**Step 5** Record your current configuration register value, so you can restore it later.

**Step 6** At the prompt, enter **Y** to change the value.

The security appliance prompts you for new values.

**Step 7** Accept the default values for all settings, except for the “disable system configuration?” value; at that prompt, enter **Y**.

**Step 8** Reload the security appliance by entering the following command:

```
rommon #2> boot
```

The security appliance loads a default configuration instead of the startup configuration.

**Step 9** Enter privileged EXEC mode by entering the following command:

```
hostname> enable
```

**Step 10** When prompted for the password, press **Return**.

The password is blank.

**Step 11** Load the startup configuration by entering the following command:

```
hostname# copy startup-config running-config
```

**Step 12** Enter global configuration mode by entering the following command:

```
hostname# configure terminal
```

**Step 13** Change the passwords in the configuration by entering the following commands, as necessary:

```
hostname(config)# password password
hostname(config)# enable password password
hostname(config)# username name password password
```

**Step 14** Change the configuration register to load the startup configuration at the next reload by entering the following command:

```
hostname(config)# config-register value
```

Where *value* is the configuration register value you noted in [Step 5](#). 0x1 is the default configuration register. For more information about the configuration register, see the *Cisco Security Appliance Command Reference*.

**Step 15** Save the new passwords to the startup configuration by entering the following command:

```
hostname(config)# copy running-config startup-config
```

---

## Password Recovery for the PIX 500 Series Security Appliance

Performing password recovery on the security appliance erases the login password, enable password, and **aaa authentication console** commands. To erase these commands so you can log in with the default passwords, perform the following steps:

- 
- Step 1** Download the PIX password tool from Cisco.com to a TFTP server accessible from the security appliance. See the link in the “Password Recovery Procedure for the PIX” document at the following URL:
- `http://www.cisco.com/en/US/products/hw/vpndevc/ps2030/products_password_recovery09186a008009478b.shtml`
- Step 2** Connect to the security appliance console port according to the “[Accessing the Command-Line Interface](#)” section on page 2-1.
- Step 3** Power off the security appliance, and then power it on.
- Step 4** Immediately after the startup messages appear, press the **Escape** key to enter monitor mode.
- Step 5** Configure the network settings for the interface that accesses the TFTP server by entering the following commands:
- ```
monitor> interface interface_id
monitor> address interface_ip
monitor> server tftp_ip
monitor> file pw_tool_name
monitor> gateway gateway_ip
```
- Step 6** Download the PIX password tool from the TFTP server by entering the following command:
- ```
monitor> tftp
```
- If you have trouble reaching the server, you can enter the **ping address** command to test the connection.
- Step 7** At the “Do you wish to erase the passwords?” prompt, enter **Y**.  
You can now log in with the default login password of “cisco” and the blank enable password.
- 

The following example shows the PIX password recovery with the TFTP server on the outside interface:

```
monitor> interface 0
0: i8255X @ PCI(bus:0 dev:13 irq:10)
1: i8255X @ PCI(bus:0 dev:14 irq:7)

Using 0: i82559 @ PCI(bus:0 dev:13 irq:10), MAC: 0050.54ff.82b9
monitor> address 10.21.1.99
address 10.21.1.99
monitor> server 172.18.125.3
server 172.18.125.3
monitor> file np70.bin
file np52.bin
monitor> gateway 10.21.1.1
gateway 10.21.1.1
monitor> ping 172.18.125.3
Sending 5, 100-byte 0xf8d3 ICMP Echoes to 172.18.125.3, timeout is 4 seconds:
!!!!
Success rate is 100 percent (5/5)
monitor> tftp
tftp np52.bin@172.18.125.3 via 10.21.1.1.....
Received 73728 bytes
```

```

Cisco PIX password tool (4.0) #0: Tue Aug 22 23:22:19 PDT 2005
Flash=i28F640J5 @ 0x300
BIOS Flash=AT29C257 @ 0xd8000

Do you wish to erase the passwords? [yn] y
Passwords have been erased.

Rebooting....

```

## Disabling Password Recovery

You might want to disable password recovery to ensure that unauthorized users cannot use the password recovery mechanism to compromise the security appliance. To disable password recovery, enter the following command:

```
hostname(config)# no service password-recovery
```

On the ASA 5500 series adaptive security appliance, the **no service password-recovery** command prevents a user from entering ROMMON with the configuration intact. When a user enters ROMMON, the security appliance prompts the user to erase all Flash file systems. The user cannot enter ROMMON without first performing this erasure. If a user chooses not to erase the Flash file system, the security appliance reloads. Because password recovery depends on using ROMMON and maintaining the existing configuration, this erasure prevents you from recovering a password. However, disabling password recovery prevents unauthorized users from viewing the configuration or inserting different passwords. In this case, to recover the system to an operating state, load a new image and a backup configuration file, if available. The **service password-recovery** command appears in the configuration file for informational purposes only; when you enter the command at the CLI prompt, the setting is saved in NVRAM. The only way to change the setting is to enter the command at the CLI prompt. Loading a new configuration with a different version of the command does not change the setting. If you disable password recovery when the security appliance is configured to ignore the startup configuration at startup (in preparation for password recovery), then the security appliance changes the setting to boot the startup configuration as usual. If you use failover, and the standby unit is configured to ignore the startup configuration, then the same change is made to the configuration register when the **no service password recovery** command replicates to the standby unit.

On the PIX 500 series security appliance, the **no service password-recovery** command forces the PIX password tool to prompt the user to erase all Flash file systems. The user cannot use the PIX password tool without first performing this erasure. If a user chooses not to erase the Flash file system, the security appliance reloads. Because password recovery depends on maintaining the existing configuration, this erasure prevents you from recovering a password. However, disabling password recovery prevents unauthorized users from viewing the configuration or inserting different passwords. In this case, to recover the system to an operating state, load a new image and a backup configuration file, if available.

## Other Troubleshooting Tools

The security appliance provides other troubleshooting tools to be used in conjunction with Cisco TAC:

- [Viewing Debug Messages, page 33-13](#)
- [Capturing Packets, page 33-13](#)
- [Viewing the Crash Dump, page 33-13](#)

## Viewing Debug Messages

Because debugging output is assigned high priority in the CPU process, it can render the system unusable. For this reason, use **debug** commands only to troubleshoot specific problems or during troubleshooting sessions with Cisco TAC. Moreover, it is best to use **debug** commands during periods of lower network traffic and fewer users. Debugging during these periods decreases the likelihood that increased debug command processing overhead will affect system use. To enable debug messages, see the **debug** commands in the *Cisco Security Appliance Command Reference*.

## Capturing Packets

Capturing packets is sometimes useful when troubleshooting connectivity problems or monitoring suspicious activity. We recommend contacting Cisco TAC if you want to use the packet capture feature. See the **capture** command in the *Cisco Security Appliance Command Reference*.

## Viewing the Crash Dump

If the security appliance crashes, you can view the crash dump information. We recommend contacting Cisco TAC if you want to interpret the crash dump. See the **show crashdump** command in the *Cisco Security Appliance Command Reference*.

## Common Problems

This section describes common problems with the security appliance, and how you might resolve them.

**Symptom** The context configuration was not saved, and was lost when you reloaded.

**Possible Cause** You did not save each context within the context execution space. If you are configuring contexts at the command line, you did not save the context before you changed to the next context.

**Recommended Action** Save each context within the context execution space using the **copy run start** command. You cannot save contexts from the system execution space.

**Symptom** You cannot make a Telnet connection or SSH to the security appliance interface.

**Possible Cause** You did not enable Telnet or SSH to the security appliance.

**Recommended Action** Enable Telnet or SSH to the security appliance according to the [“Allowing Telnet Access” section on page 31-1](#) or the [“Allowing SSH Access” section on page 31-2](#).

**Symptom** You cannot ping the security appliance interface.

**Possible Cause** You disabled ICMP to the security appliance.

**Recommended Action** Enable ICMP to the security appliance for your IP address using the **icmp** command.

**Symptom** You cannot ping through the security appliance, even though the access list allows it.

**Possible Cause** You did not enable the ICMP inspection engine or apply access lists on both the ingress and egress interfaces.

**Recommended Action** Because ICMP is a connectionless protocol, the security appliance does not automatically allow returning traffic through. In addition to an access list on the ingress interface, you either need to apply an access list to egress interface to allow replying traffic, or enable the ICMP inspection engine, which treats ICMP connections as stateful connections.

**Symptom** Traffic does not pass between two interfaces on the same security level.

**Possible Cause** You did not enable the feature that allows traffic to pass between interfaces on the same security level.

**Recommended Action** Enable this feature according to the [“Allowing Communication Between Interfaces on the Same Security Level”](#) section on page 6-5.





## **PART 5**

### **Reference**







## Feature Licenses and Specifications

---

This appendix describes the feature licenses and specifications. This appendix includes the following sections:

- [Supported Platforms, page A-1](#)
- [Platform Feature Licenses, page A-1](#)
- [Security Services Module Support, page A-6](#)
- [VPN Specifications, page A-6](#)

## Supported Platforms

This software version supports the following platforms:

- ASA 5510
- ASA 5520
- ASA 5540
- PIX 515/515E
- PIX 525
- PIX 535

## Platform Feature Licenses

The following tables list the feature support for each platform license.



### Note

Items that are in italics are separate, optional licenses that you can add on to a base license. You can mix and match licenses, for example, the 10 security context license plus the Strong Encryption license; or the VPN Plus license plus the GTP/GPRS license; or all four licenses together.

---

Table A-1 ASA 5500 Series Adaptive Security Appliance License Features

| Platforms and Features              | Licenses                                                                                          |                                                         |
|-------------------------------------|---------------------------------------------------------------------------------------------------|---------------------------------------------------------|
| <b>ASA 5510<sup>1</sup></b>         | <b>Base License</b>                                                                               | <b>Security Plus</b>                                    |
| Security Contexts                   | No support                                                                                        | No support                                              |
| VPN Peers                           | 50 IPSec<br>50 WebVPN                                                                             | 150 IPSec<br>150 WebVPN                                 |
| Failover                            | None                                                                                              | Active/Standby                                          |
| GTP/GPRS                            | Not supported                                                                                     | Not supported                                           |
| Maximum VLANs                       | 0                                                                                                 | 10                                                      |
| Concurrent Connections <sup>2</sup> | 32 K                                                                                              | 64 K                                                    |
| Max. Physical Interfaces            | 3 at 10/100 plus the Management interface for management traffic only (to-the-security-appliance) | Unlimited                                               |
| Encryption                          | Base (DES) <i>Add-on license:<br/>Strong (3DES/AES)</i>                                           | Base (DES) <i>Add-on license:<br/>Strong (3DES/AES)</i> |
| Minimum RAM                         | 256 MB                                                                                            | 256 MB                                                  |
| <b>ASA 5520</b>                     | <b>Base License</b>                                                                               | <b>N/A</b>                                              |
| Security Contexts                   | 2 <i>Add-on Licenses:</i><br>5      10                                                            |                                                         |
| VPN Peers                           | 300 IPSec<br>300 WebVPN <i>Add-on license:<br/>VPN Plus<br/>750 IPSec<br/>750 WebVPN</i>          |                                                         |
| Failover                            | Active/Standby<br>Active/Active                                                                   |                                                         |
| GTP/GPRS                            | None <i>Add-on license: Enabled</i>                                                               |                                                         |
| Maximum VLANs                       | 25                                                                                                |                                                         |
| Concurrent Connections <sup>2</sup> | 130 K                                                                                             |                                                         |
| Max. Physical Interfaces            | Unlimited                                                                                         |                                                         |
| Encryption                          | Base (DES) <i>Add-on license:<br/>Strong (3DES/AES)</i>                                           |                                                         |
| Minimum RAM                         | 512 MB                                                                                            |                                                         |

Table A-1 ASA 5500 Series Adaptive Security Appliance License Features (continued)

| Platforms and Features              | Licenses                        |                                                                        |    |                                                                           | N/A |
|-------------------------------------|---------------------------------|------------------------------------------------------------------------|----|---------------------------------------------------------------------------|-----|
| <b>ASA 5540</b>                     | <b>Base License</b>             |                                                                        |    |                                                                           |     |
| Security Contexts                   | 2                               | <i>Add-on licenses:</i>                                                |    |                                                                           |     |
|                                     |                                 | 5                                                                      | 10 | 20                                                                        | 50  |
| VPN Peers                           | 500 IPSec<br>500 WebVPN         | <i>Add-on license:</i><br><i>VPN Plus</i><br>2000 IPSec<br>1250 WebVPN |    | <i>Add-on license:</i><br><i>VPN Premium</i><br>5000 IPSec<br>2500 WebVPN |     |
| Failover                            | Active/Standby<br>Active/Active |                                                                        |    |                                                                           |     |
| GTP/GPRS                            | None                            | <i>Add-on license: Enabled</i>                                         |    |                                                                           |     |
| Maximum VLANs                       | 100                             |                                                                        |    |                                                                           |     |
| Concurrent Connections <sup>2</sup> | 280 K                           |                                                                        |    |                                                                           |     |
| Max. Physical Interfaces            | Unlimited                       |                                                                        |    |                                                                           |     |
| Encryption                          | Base (DES)                      | <i>Add-on license:</i><br><i>Strong (3DES/AES)</i>                     |    |                                                                           |     |
| Minimum RAM                         | 1024 MB                         |                                                                        |    |                                                                           |     |

1. The ASA 5510 does not support VPN load balancing.

2. The concurrent connections are based on a traffic mix of 80% TCP and 20% UDP, with one host and one dynamic translation for every four connections.

Table A-2 PIX 500 Series Security Appliance License Features

| Platforms and Features              | Licenses              |                                           |                                                       |                                 |                                           |                                                       |                                  |                                           |                                                       |                                                   |                                           |                                                       |    |    |                         |  |  |  |
|-------------------------------------|-----------------------|-------------------------------------------|-------------------------------------------------------|---------------------------------|-------------------------------------------|-------------------------------------------------------|----------------------------------|-------------------------------------------|-------------------------------------------------------|---------------------------------------------------|-------------------------------------------|-------------------------------------------------------|----|----|-------------------------|--|--|--|
| <b>PIX 515/515E<sup>1</sup></b>     | <b>R (Restricted)</b> |                                           |                                                       | <b>UR (Unrestricted)</b>        |                                           |                                                       | <b>FO (Failover)<sup>2</sup></b> |                                           |                                                       | <b>FO-AA (Failover Active/Active)<sup>2</sup></b> |                                           |                                                       |    |    |                         |  |  |  |
| Security Contexts                   | No support            |                                           |                                                       | 2                               | <i>Add-on license:</i>                    |                                                       |                                  |                                           | 2                                                     | <i>Add-on license:</i>                            |                                           |                                                       |    |    |                         |  |  |  |
|                                     |                       |                                           |                                                       | 5                               |                                           |                                                       |                                  |                                           | 5                                                     |                                                   |                                           |                                                       |    |    |                         |  |  |  |
| VPN Peers                           | 2000 IPSec            |                                           |                                                       | 2000 IPSec                      |                                           |                                                       | 2000 IPSec                       |                                           |                                                       | 2000 IPSec                                        |                                           |                                                       |    |    |                         |  |  |  |
| Failover                            | No support            |                                           |                                                       | Active/Standby<br>Active/Active |                                           |                                                       | Active/Standby                   |                                           |                                                       | Active/Standby<br>Active/Active                   |                                           |                                                       |    |    |                         |  |  |  |
| GTP/GPRS                            | None                  | <i>Add-on license:<br/>Enabled</i>        |                                                       | None                            | <i>Add-on license:<br/>Enabled</i>        |                                                       | None                             | <i>Add-on license:<br/>Enabled</i>        |                                                       | None                                              | <i>Add-on license:<br/>Enabled</i>        |                                                       |    |    |                         |  |  |  |
| Maximum VLANs                       | 10                    |                                           |                                                       | 25                              |                                           |                                                       | 25                               |                                           |                                                       | 25                                                |                                           |                                                       |    |    |                         |  |  |  |
| Concurrent Connections <sup>3</sup> | 48 K                  |                                           |                                                       | 130 K                           |                                           |                                                       | 130 K                            |                                           |                                                       | 130 K                                             |                                           |                                                       |    |    |                         |  |  |  |
| Max. Physical Interfaces            | 3                     |                                           |                                                       | 6                               |                                           |                                                       | 6                                |                                           |                                                       | 6                                                 |                                           |                                                       |    |    |                         |  |  |  |
| Encryption                          | None                  | <i>Add-on license:<br/>Base<br/>(DES)</i> | <i>Add-on license:<br/>Strong<br/>(3DES/<br/>AES)</i> | None                            | <i>Add-on license:<br/>Base<br/>(DES)</i> | <i>Add-on license:<br/>Strong<br/>(3DES/<br/>AES)</i> | None                             | <i>Add-on license:<br/>Base<br/>(DES)</i> | <i>Add-on license:<br/>Strong<br/>(3DES/<br/>AES)</i> | None                                              | <i>Add-on license:<br/>Base<br/>(DES)</i> | <i>Add-on license:<br/>Strong<br/>(3DES/<br/>AES)</i> |    |    |                         |  |  |  |
| Minimum RAM                         | 64 MB                 |                                           |                                                       | 128 MB                          |                                           |                                                       | 128 MB                           |                                           |                                                       | 128 MB                                            |                                           |                                                       |    |    |                         |  |  |  |
| <b>PIX 525<sup>1</sup></b>          | <b>R (Restricted)</b> |                                           |                                                       | <b>UR (Unrestricted)</b>        |                                           |                                                       |                                  | <b>FO (Failover)<sup>2</sup></b>          |                                                       |                                                   |                                           | <b>FO-AA (Failover Active/Active)<sup>2</sup></b>     |    |    |                         |  |  |  |
| Security Contexts                   | No support            |                                           |                                                       | 2                               | <i>Add-on licenses:</i>                   |                                                       |                                  |                                           | 2                                                     | <i>Add-on licenses:</i>                           |                                           |                                                       |    | 2  | <i>Add-on licenses:</i> |  |  |  |
|                                     |                       |                                           |                                                       | 5                               | 10                                        | 20                                                    | 50                               | 5                                         | 10                                                    | 20                                                | 50                                        | 5                                                     | 10 | 20 | 50                      |  |  |  |
| VPN Peers                           | 2000 IPSec            |                                           |                                                       | 2000 IPSec                      |                                           |                                                       |                                  | 2000 IPSec                                |                                                       |                                                   |                                           | 2000 IPSec                                            |    |    |                         |  |  |  |
| Failover                            | No support            |                                           |                                                       | Active/Standby<br>Active/Active |                                           |                                                       |                                  | Active/Standby                            |                                                       |                                                   |                                           | Active/Standby<br>Active/Active                       |    |    |                         |  |  |  |
| GTP/GPRS                            | None                  | <i>Add-on license:<br/>Enabled</i>        |                                                       | None                            | <i>Add-on license:<br/>Enabled</i>        |                                                       | None                             | <i>Add-on license:<br/>Enabled</i>        |                                                       | None                                              | <i>Add-on license:<br/>Enabled</i>        |                                                       |    |    |                         |  |  |  |
| Maximum VLANs                       | 25                    |                                           |                                                       | 100                             |                                           |                                                       |                                  | 100                                       |                                                       |                                                   |                                           | 100                                                   |    |    |                         |  |  |  |
| Concurrent Connections <sup>3</sup> | 140 K                 |                                           |                                                       | 280 K                           |                                           |                                                       |                                  | 280 K                                     |                                                       |                                                   |                                           | 280 K                                                 |    |    |                         |  |  |  |
| Max. Physical Interfaces            | 6                     |                                           |                                                       | 10                              |                                           |                                                       |                                  | 10                                        |                                                       |                                                   |                                           | 10                                                    |    |    |                         |  |  |  |
| Encryption                          | None                  | <i>Add-on license:<br/>Base<br/>(DES)</i> | <i>Add-on license:<br/>Strong<br/>(3DES/<br/>AES)</i> | None                            | <i>Add-on license:<br/>Base<br/>(DES)</i> | <i>Add-on license:<br/>Strong<br/>(3DES/<br/>AES)</i> | None                             | <i>Add-on license:<br/>Base<br/>(DES)</i> | <i>Add-on license:<br/>Strong<br/>(3DES/<br/>AES)</i> | None                                              | <i>Add-on license:<br/>Base<br/>(DES)</i> | <i>Add-on license:<br/>Strong<br/>(3DES/<br/>AES)</i> |    |    |                         |  |  |  |
| Minimum RAM                         | 128 MB                |                                           |                                                       | 256 MB                          |                                           |                                                       |                                  | 256 MB                                    |                                                       |                                                   |                                           | 256 MB                                                |    |    |                         |  |  |  |

Table A-2 PIX 500 Series Security Appliance License Features (continued)

| Platforms and Features              | Licenses       |                                           |                                                       |                                 |                                           |                                                       |      |                                           |                                                       |      |                                           |                                                       |                                    |  |   |    |    |    |
|-------------------------------------|----------------|-------------------------------------------|-------------------------------------------------------|---------------------------------|-------------------------------------------|-------------------------------------------------------|------|-------------------------------------------|-------------------------------------------------------|------|-------------------------------------------|-------------------------------------------------------|------------------------------------|--|---|----|----|----|
|                                     | R (Restricted) |                                           |                                                       | UR (Unrestricted)               |                                           |                                                       |      | FO (Failover) <sup>2</sup>                |                                                       |      |                                           | FO-AA (Failover Active/Active) <sup>2</sup>           |                                    |  |   |    |    |    |
| PIX 535 <sup>1</sup>                |                |                                           |                                                       |                                 |                                           |                                                       |      |                                           |                                                       |      |                                           |                                                       |                                    |  |   |    |    |    |
| Security Contexts                   | No support     |                                           |                                                       | 2                               | <i>Add-on licenses:</i>                   |                                                       |      | 2                                         | <i>Add-on licenses:</i>                               |      |                                           | 2                                                     | <i>Add-on licenses:</i>            |  |   |    |    |    |
|                                     |                |                                           |                                                       |                                 | 5                                         | 10                                                    | 20   | 50                                        |                                                       | 5    | 10                                        | 20                                                    | 50                                 |  | 5 | 10 | 20 | 50 |
| VPN Peers                           | 2000 IPSec     |                                           |                                                       | 2000 IPSec                      |                                           |                                                       |      | 2000 IPSec                                |                                                       |      |                                           | 2000 IPSec                                            |                                    |  |   |    |    |    |
| Failover                            | No support     |                                           |                                                       | Active/Standby<br>Active/Active |                                           |                                                       |      | Active/Standby                            |                                                       |      |                                           | Active/Standby<br>Active/Active                       |                                    |  |   |    |    |    |
| GTP/GPRS                            | None           | <i>Add-on license:<br/>Enabled</i>        |                                                       | None                            | <i>Add-on license:<br/>Enabled</i>        |                                                       |      | None                                      | <i>Add-on license:<br/>Enabled</i>                    |      |                                           | None                                                  | <i>Add-on license:<br/>Enabled</i> |  |   |    |    |    |
| Max. VLANs                          | 50             |                                           |                                                       | 150                             |                                           |                                                       |      | 150                                       |                                                       |      |                                           | 150                                                   |                                    |  |   |    |    |    |
| Concurrent Connections <sup>3</sup> | 250 K          |                                           |                                                       | 500 K                           |                                           |                                                       |      | 500 K                                     |                                                       |      |                                           | 500 K                                                 |                                    |  |   |    |    |    |
| Max. Physical Interfaces            | 8              |                                           |                                                       | 14                              |                                           |                                                       |      | 14                                        |                                                       |      |                                           | 14                                                    |                                    |  |   |    |    |    |
| Encryption                          | None           | <i>Add-on license:<br/>Base<br/>(DES)</i> | <i>Add-on license:<br/>Strong<br/>(3DES/<br/>AES)</i> | None                            | <i>Add-on license:<br/>Base<br/>(DES)</i> | <i>Add-on license:<br/>Strong<br/>(3DES/<br/>AES)</i> | None | <i>Add-on license:<br/>Base<br/>(DES)</i> | <i>Add-on license:<br/>Strong<br/>(3DES/<br/>AES)</i> | None | <i>Add-on license:<br/>Base<br/>(DES)</i> | <i>Add-on license:<br/>Strong<br/>(3DES/<br/>AES)</i> |                                    |  |   |    |    |    |
| Minimum RAM                         | 512 MB         |                                           |                                                       | 1024 MB                         |                                           |                                                       |      | 1024 MB                                   |                                                       |      |                                           | 1024 MB                                               |                                    |  |   |    |    |    |

1. The PIX 500 series security appliance does not support WebVPN.

2. This license can only be used in a failover pair with another unit with a UR license. Both units must be the same model.

3. The concurrent connections are based on a traffic mix of 80% TCP and 20% UDP, with one host and one dynamic translation for every four connections.

# Security Services Module Support

Table A-3 shows the SSMs supported by each platform:

**Table A-3**      **SSM Support**

| Platform     | SSM Models                          |
|--------------|-------------------------------------|
| ASA 5510     | AIP SSM 10<br>4GE SSM               |
| ASA 5520     | AIP SSM 10<br>AIP SSM 20<br>4GE SSM |
| ASA 5540     | AIP SSM 10<br>AIP SSM 20<br>4GE SSM |
| PIX 515/515E | No support                          |
| PIX 525      | No support                          |
| PIX 535      | No support                          |

## VPN Specifications

This section describes the VPN specifications for the security appliance. This section includes the following topics:

- [Cisco VPN Client Support, page A-7](#)
- [Site-to-Site VPN Compatibility, page A-7](#)
- [Cryptographic Standards, page A-8](#)



## Cisco VPN Client Support

The security appliance supports a wide variety of software and hardware-based Cisco VPN clients, as shown in [Table A-4](#).

**Table A-4** *Cisco VPN Client Support*

| Client Type                                        | Client Versions                                                                                                                                                                                                                                              |
|----------------------------------------------------|--------------------------------------------------------------------------------------------------------------------------------------------------------------------------------------------------------------------------------------------------------------|
| Software IPsec VPN clients                         | Cisco VPN client for Windows, Version 3.6 or higher<br>Cisco VPN client for Linux, Version 3.6 or higher<br>Cisco VPN client for Solaris, Version 3.6 or higher<br>Cisco VPN client for Mac OS X, Version 3.6 or higher                                      |
| Hardware IPsec VPN clients (Cisco Easy VPN remote) | Cisco VPN 3002 hardware client, Version 3.0 or higher<br>Cisco IOS Software Easy VPN remote, Release 12.2(8)YJ<br>Cisco PIX 500 series security appliance, Version 6.2 or higher<br>Cisco ASA 5500 series adaptive security appliance, Version 7.0 or higher |

## Site-to-Site VPN Compatibility

In addition to providing interoperability for many third-party VPN products, the security appliance interoperates with the Cisco VPN products for site-to-site VPN connectivity shown in [Table A-5](#).

**Table A-5** *Site-to-Site VPN Compatibility*

| Platforms                                          | Software Versions          |
|----------------------------------------------------|----------------------------|
| Cisco ASA 5500 series adaptive security appliances | Version 7.0 or higher      |
| Cisco IOS routers                                  | Release 12.1(6)T or higher |
| Cisco PIX 500 series security appliances           | Version 5.1(1) or higher   |
| Cisco VPN 3000 series concentrators                | Version 2.5.2 or higher    |

## Cryptographic Standards

The security appliance supports numerous cryptographic standards and related third-party products and services, including those shown in [Table A-6](#).

**Table A-6** *Cryptographic Standards*

| Type                                                     | Description                                                                                                                                           |
|----------------------------------------------------------|-------------------------------------------------------------------------------------------------------------------------------------------------------|
| Asymmetric (public key) encryption algorithms            | RSA public/private key pairs, 512 bits to 4096 bits<br>DSA public/private key pairs, 512 bits to 1024 bits                                            |
| Symmetric encryption algorithms                          | AES—128, 192, and 256 bits<br>DES—56 bits<br>3DES—168 bits<br>RC4—40, 56, 64, and 128 bits                                                            |
| Perfect forward secrecy (Diffie-Hellman key negotiation) | Group 1— 768 bits<br>Group 2—1024 bits<br>Group 5— 1536 bits<br>Group 7—163 bits (Elliptic Curve Diffie-Hellman)                                      |
| Hash algorithms                                          | MD5—128 bits<br>SHA-1—160 bits                                                                                                                        |
| X.509 certificate authorities                            | Cisco IOS software<br>Baltimore UniCERT<br>Entrust Authority<br>iPlanet/Netscape CMS<br>Microsoft Certificate Services<br>RSA Keon<br>VeriSign OnSite |
| X.509 certificate enrollment methods                     | SCEP<br>PKCS #7 and #10                                                                                                                               |



## Sample Configurations

---

This appendix illustrates and describes a number of common ways to implement the security appliance, and includes the following topics:

- [Example 1: Multiple Mode Firewall With Outside Access, page 1](#)
- [Example 2: Single Mode Firewall Using Same Security Level, page 5](#)
- [Example 3: Shared Resources for Multiple Contexts, page 7](#)
- [Example 4: Multiple Mode, Transparent Firewall with Outside Access, page 12](#)
- [Example 5: WebVPN Configuration, page 15](#)

For failover examples, see [Chapter 11, “Failover Configuration Examples,”](#)

### Example 1: Multiple Mode Firewall With Outside Access

This configuration creates three security contexts plus the admin context, each with an inside and an outside interface. The Customer C context includes a DMZ interface where a Websense server for HTTP filtering resides on the service provider premises (see [Figure B-1](#)).

Inside hosts can access the Internet through the outside using dynamic NAT or PAT, but no outside hosts can access the inside.

The Customer A context has a second network behind an inside router.

The admin context allows SSH sessions to the security appliance from one host.

Although inside IP addresses can be the same across contexts when the interfaces are unique, keeping them unique is easier to manage.

Figure B-1 Example 1

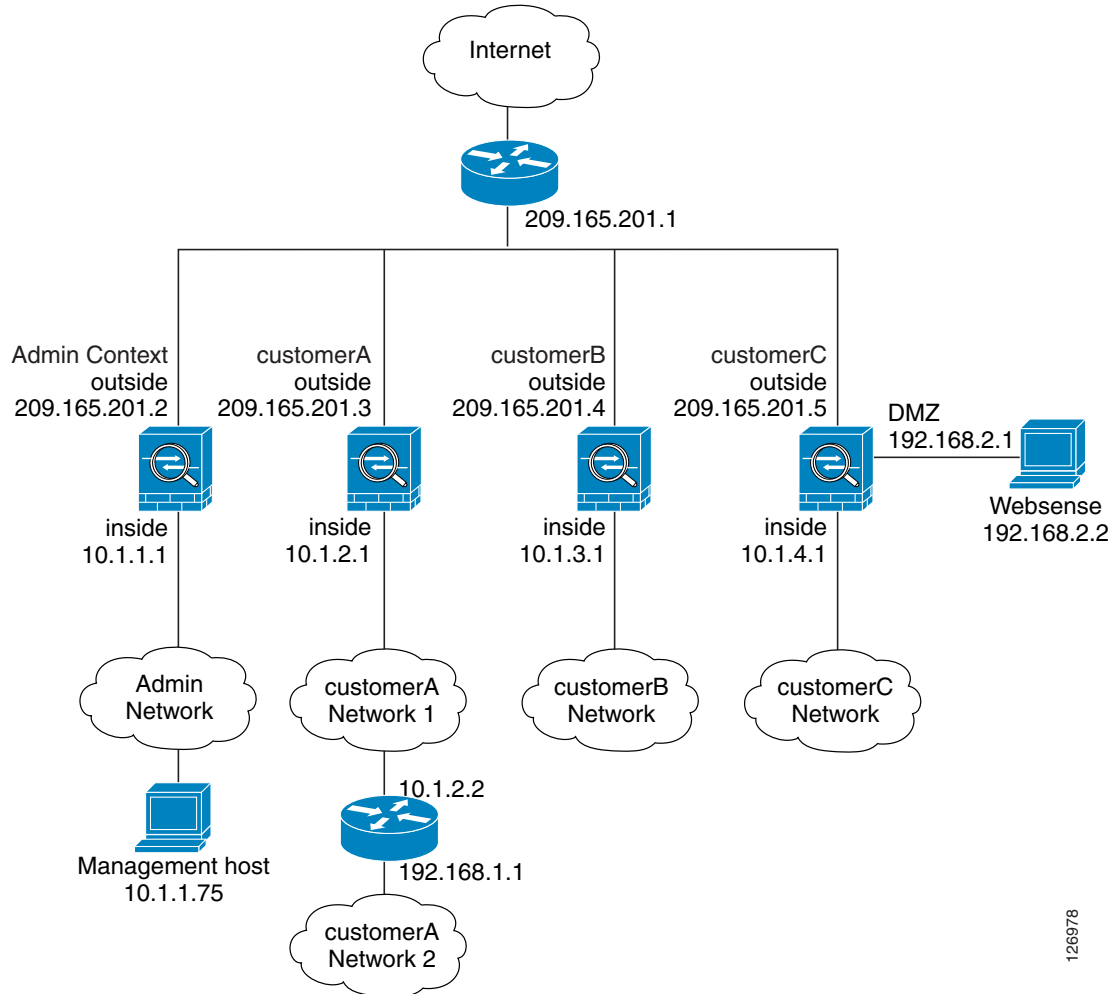

126978

See the following sections for the configurations for this scenario:

- [Example 1: System Configuration, page 2](#)
- [Example 1: Admin Context Configuration, page 3](#)
- [Example 1: Customer A Context Configuration, page 4](#)
- [Example 1: Customer B Context Configuration, page 4](#)
- [Example 1: Customer C Context Configuration, page 5](#)

## Example 1: System Configuration

You must first enable multiple context mode using the **mode multiple** command. The mode is not stored in the configuration file, even though it endures reboots. If you view the configuration on the security appliance using the **write terminal**, **show startup-config**, or **show running-config** commands, the mode displays after the security appliance Version (blank means single mode, “<system>” means you are in multiple mode in the system configuration, and <context> means you are in multiple mode in a context).

```

hostname Farscape
password passw0rd
enable password chr1cht0n
admin-context admin
interface gigabitethernet 0/0
 shutdown
interface gigabitethernet 0/0.3
 vlan 3
 no shutdown
interface gigabitethernet 0/1
 no shutdown
interface gigabitethernet 0/1.4
 vlan 4
 no shutdown
interface gigabitethernet 0/1.5
 vlan 5
 no shutdown
interface gigabitethernet 0/1.6
 vlan 6
 no shutdown
interface gigabitethernet 0/1.7
 vlan 7
 no shutdown
interface gigabitethernet 0/1.8
 vlan 8
 no shutdown
context admin
 allocate-interface gigabitethernet 0/0.3
 allocate-interface gigabitethernet 0/1.4
 config-url disk0://admin.cfg
context customerA
 description This is the context for customer A
 allocate-interface gigabitethernet 0/0.3
 allocate-interface gigabitethernet 0/1.5
 config-url disk0://contexta.cfg
context customerB
 description This is the context for customer B
 allocate-interface gigabitethernet 0/0.3
 allocate-interface gigabitethernet 0/1.6
 config-url disk0://contextb.cfg
context customerC
 description This is the context for customer C
 allocate-interface gigabitethernet 0/0.3
 allocate-interface gigabitethernet 0/1.7-gigabitethernet 0/1.8
 config-url disk0://contextc.cfg

```

## Example 1: Admin Context Configuration

The host at 10.1.1.75 can access the context using SSH, which requires a key to be generated using the **crypto key generate** command.

```

hostname Admin
domain isp
interface gigabitethernet 0/0.3
 nameif outside
 security-level 0
 ip address 209.165.201.2 255.255.255.224
 no shutdown
interface gigabitethernet 0/1.4
 nameif inside
 security-level 100

```

### Example 1: Multiple Mode Firewall With Outside Access

```

ip address 10.1.1.1 255.255.255.0
no shutdown
passwd secret1969
enable password hlandl0
route outside 0 0 209.165.201.1 1
ssh 10.1.1.75 255.255.255.255 inside
nat (inside) 1 10.1.1.0 255.255.255.0
! This context uses dynamic NAT for inside users that access the outside
global (outside) 1 209.165.201.10-209.165.201.29
! The host at 10.1.1.75 has access to the Websense server in Customer C, so
! it needs a static translation for use in Customer C's access list
static (inside,outside) 209.165.201.30 10.1.1.75 netmask 255.255.255.255

```

## Example 1: Customer A Context Configuration

```

interface gigabitethernet 0/0.3
nameif outside
security-level 0
ip address 209.165.201.3 255.255.255.224
no shutdown
interface gigabitethernet 0/1.5
nameif inside
security-level 100
ip address 10.1.2.1 255.255.255.0
no shutdown
passwd hell0!
enable password enter55
route outside 0 0 209.165.201.1 1
! The Customer A context has a second network behind an inside router that requires a
! static route. All other traffic is handled by the default route pointing to the router.
route inside 192.168.1.0 255.255.255.0 10.1.2.2 1
nat (inside) 1 10.1.2.0 255.255.255.0
! This context uses dynamic PAT for inside users that access that outside. The outside
! interface address is used for the PAT address
global (outside) 1 interface

```

## Example 1: Customer B Context Configuration

```

interface gigabitethernet 0/0.3
nameif outside
security-level 0
ip address 209.165.201.4 255.255.255.224
no shutdown
interface gigabitethernet 0/1.6
nameif inside
security-level 100
ip address 10.1.3.1 255.255.255.0
no shutdown
passwd tenac10us
enable password defen$e
route outside 0 0 209.165.201.1 1
nat (inside) 1 10.1.3.0 255.255.255.0
! This context uses dynamic PAT for inside users that access the outside
global (outside) 1 209.165.201.9 netmask 255.255.255.255
access-list INTERNET remark Inside users only access HTTP and HTTPS servers on the outside
access-list INTERNET extended permit tcp any any eq http
access-list INTERNET extended permit tcp any any eq https

```

```
access-group INTERNET in interface inside
```

## Example 1: Customer C Context Configuration

```
interface gigabitethernet 0/0.3
 nameif outside
 security-level 0
 ip address 209.165.201.5 255.255.255.224
 no shutdown
interface gigabitethernet 0/1.7
 nameif inside
 security-level 100
 ip address 10.1.4.1 255.255.255.0
 no shutdown
interface gigabitethernet 0/1.8
 nameif dmz
 security-level 50
 ip address 192.168.2.1 255.255.255.0
 no shutdown
passwd fl0wer
enable password treeh0u$e
route outside 0 0 209.165.201.1 1
url-server (dmz) vendor websense host 192.168.2.2 url-block block 50
url-cache dst 128
filter url http 10.1.4.0 255.255.255.0 0 0
! When inside users access an HTTP server, the security appliance consults with a
! Websense server to determine if the traffic is allowed
nat (inside) 1 10.1.4.0 255.255.255.0
! This context uses dynamic NAT for inside users that access the outside
global (outside) 1 209.165.201.9 netmask 255.255.255.255
! A host on the admin context requires access to the Websense server for management using
! pcAnywhere, so the Websense server uses a static translation for its private address
static (dmz,outside) 209.165.201.6 192.168.2.2 netmask 255.255.255.255
access-list MANAGE remark Allows the management host to use pcAnywhere on the Websense
server
access-list MANAGE extended permit tcp host 209.165.201.30 host 209.165.201.6 eq
pcanywhere-data
access-list MANAGE extended permit udp host 209.165.201.30 host 209.165.201.6 eq
pcanywhere-status
access-group MANAGE in interface outside
```

## Example 2: Single Mode Firewall Using Same Security Level

This configuration creates three internal interfaces. Two of the interfaces connect to departments that are on the same security level, which allows all hosts to communicate without using access lists. The DMZ interface hosts a Syslog server. The management host on the outside needs access to the Syslog server and the security appliance. To connect to the security appliance, the host uses a VPN connection. The security appliance uses RIP on the inside interfaces to learn routes. Because the security appliance does not advertise routes with RIP, the upstream router needs to use static routes for security appliance traffic (see [Figure B-2](#)).

The Department networks are allowed to access the Internet, and use PAT.

Figure B-2 Example 2

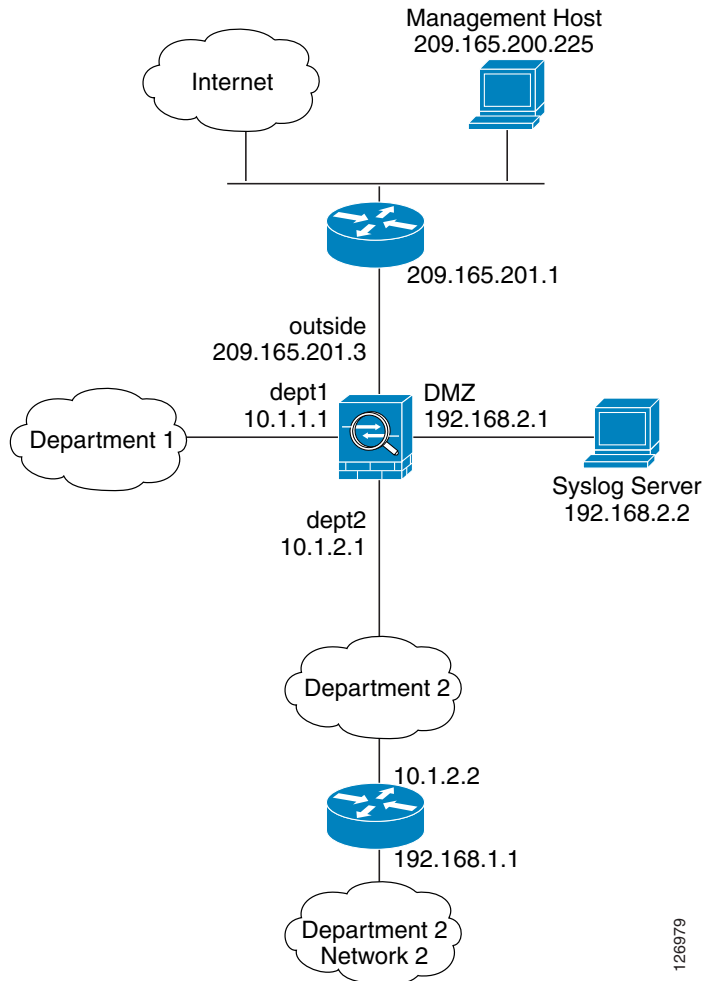

126979

```

interface gigabitethernet 0/0
 nameif outside
 security-level 0
 ip address 209.165.201.3 255.255.255.224
 no shutdown
interface gigabitethernet 0/1
 nameif dept2
 security-level 100
 ip address 10.1.2.1 255.255.255.0
 no shutdown
interface gigabitethernet 0/2
 nameif dept1
 security-level 100
 ip address 10.1.1.1 255.255.255.0
 no shutdown
interface gigabitethernet 0/3
 nameif dmz
 security-level 50
 ip address 192.168.2.1 255.255.255.0
 no shutdown
passwd g00fball
enable password genlu$
hostname Buster
same-security-traffic permit inter-interface

```



```

route outside 0 0 209.165.201.1 1
nat (dept1) 1 10.1.1.0 255.255.255.0
nat (dept2) 1 10.1.2.0 255.255.255.0
! The dept1 and dept2 networks use PAT when accessing the outside
global (outside) 1 209.165.201.9 netmask 255.255.255.255
! Because we perform dynamic NAT on these addresses for outside access, we need to perform
! NAT on them for all other interface access. This identity static statement just
! translates the local address to the same address.
static (dept1,dept2) 10.1.1.0 10.1.1.0 netmask 255.255.255.0
static (dept2,dept1) 10.1.2.0 10.1.2.0 netmask 255.255.255.0
! The syslog server uses a static translation so the outside management host can access
! the server
static (dmz,outside) 209.165.201.5 192.168.2.2 netmask 255.255.255.255
access-list MANAGE remark Allows the management host to access the syslog server
access-list MANAGE extended permit tcp host 209.165.200.225 host 209.165.201.5 eq telnet
access-group MANAGE in interface outside
! Advertises the security appliance IP address as the default gateway for the downstream
! router. The security appliance does not advertise a default route to the router.
rip dept2 default version 2 authentication md5 scorpius 1
! Listens for RIP updates from the downstream router. The security appliance does not
! listen for RIP updates from the router because a default route to the router is all that
! is required.
rip dept2 passive version 2 authentication md5 scorpius 1
! The client uses a pre-shared key to connect to the security appliance over IPSec. The
! key is the password in the username command following.
isakmp policy 1 authentication pre-share
isakmp policy 1 encryption 3des
isakmp policy 1 group 2
isakmp policy 1 hash sha
isakmp enable outside
crypto ipsec transform-set vpn_client esp-3des esp-sha-hmac
username admin password passw0rd
crypto ipsec transform-set vpn esp-3des esp-sha-hmac
crypto dynamic-map vpn_client 1 set transform-set vpn
crypto map telnet_tunnel 1 ipsec-isakmp dynamic vpn_client
crypto map telnet_tunnel interface outside
ip local pool client_pool 10.1.1.2
access-list VPN_SPLIT extended permit ip host 209.165.201.3 host 10.1.1.2
telnet 10.1.1.2 255.255.255.255 outside
telnet timeout 30
logging trap 5
! System messages are sent to the syslog server on the DMZ network
logging host dmz 192.168.2.2
logging on

```

## Example 3: Shared Resources for Multiple Contexts

This configuration includes multiple contexts for multiple departments within a company. Each department has its own security context so that each department can have its own security policy. However, the syslog, mail, and AAA servers are shared across all departments. These servers are placed on a shared interface (see [Figure B-3](#)).

Department 1 has a web server that outside users who are authenticated by the AAA server can access.

Figure B-3 Example 3

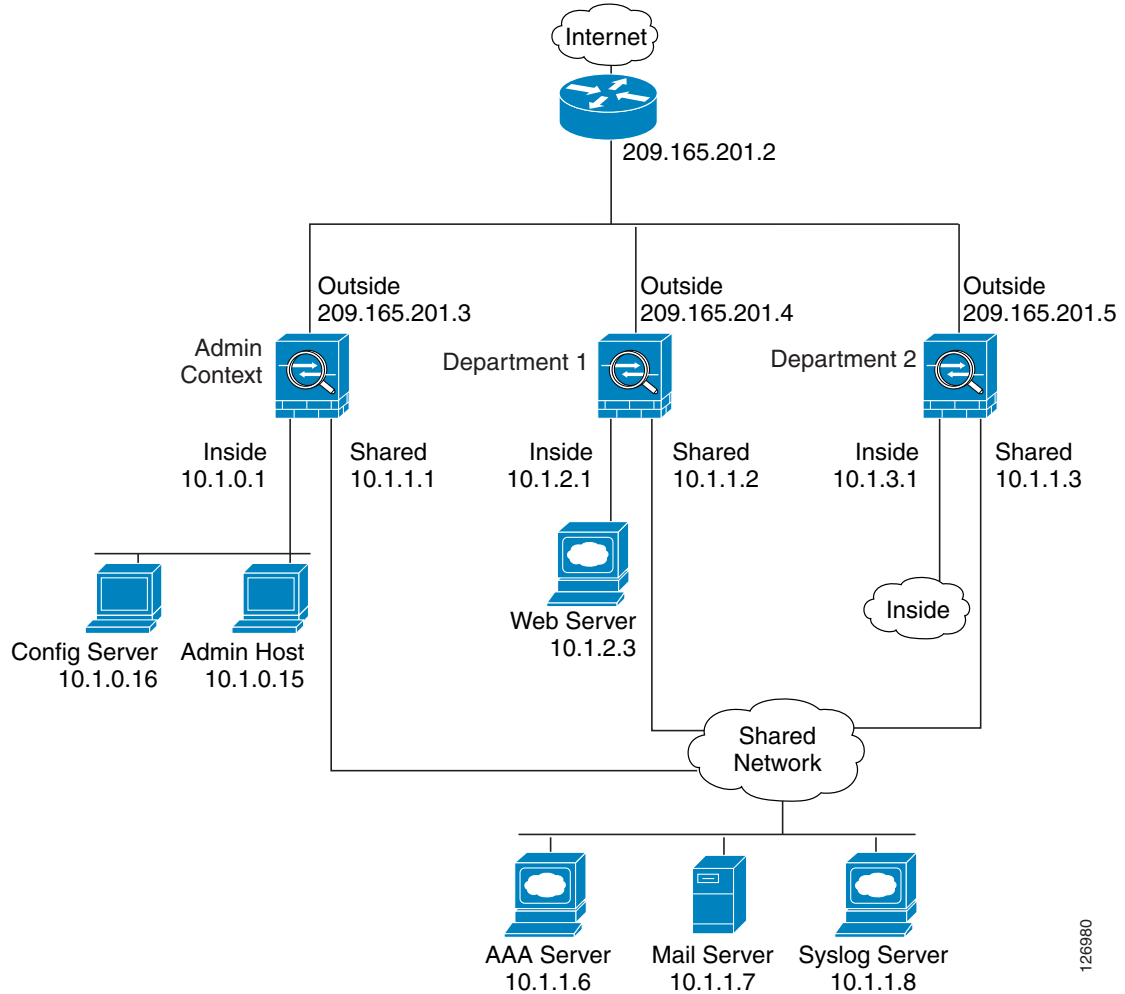

126980

See the following sections for the configurations for this scenario:

- [Example 3: System Configuration, page 8](#)
- [Example 3: Admin Context Configuration, page 9](#)
- [Example 3: Department 1 Context Configuration, page 10](#)
- [Example 3: Department 2 Context Configuration, page 11](#)

## Example 3: System Configuration

You must first enable multiple context mode using the **mode multiple** command. The mode is not stored in the configuration file, even though it endures reboots. If you view the configuration on the security appliance using the **write terminal**, **show startup-config**, or **show running-config** commands, the mode displays after the security appliance Version (blank means single mode, “<system>” means you are in multiple mode in the system configuration, and <context> means you are in multiple mode in a context).

```

hostname Ubik
password pkd55
enable password deckard69
admin-context admin
interface gigabitethernet 0/0
 no shutdown
interface gigabitethernet 0/0.200
 vlan 200
 no shutdown
interface gigabitethernet 0/1
 shutdown
interface gigabitethernet 0/1.201
 vlan 201
 no shutdown
interface gigabitethernet 0/1.202
 vlan 202
 no shutdown
interface gigabitethernet 0/1.300
 vlan 300
 no shutdown
context admin
 allocate-interface gigabitethernet 0/0.200
 allocate-interface gigabitethernet 0/1.201
 allocate-interface gigabitethernet 0/1.300
 config-url disk0://admin.cfg
context department1
 allocate-interface gigabitethernet 0/0.200
 allocate-interface gigabitethernet 0/1.202
 allocate-interface gigabitethernet 0/1.300
 config-url ftp://admin:passw0rd@10.1.0.16/dept1.cfg
context department2
 allocate-interface gigabitethernet 0/0.200
 allocate-interface gigabitethernet 0/1.203
 allocate-interface gigabitethernet 0/1.300
 config-url ftp://admin:passw0rd@10.1.0.16/dept2.cfg

```

### Example 3: Admin Context Configuration

```

hostname Admin
interface gigabitethernet 0/0.200
 nameif outside
 security-level 0
 ip address 209.165.201.3 255.255.255.224
 no shutdown
interface gigabitethernet 0/0.201
 nameif inside
 security-level 100
 ip address 10.1.0.1 255.255.255.0
 no shutdown
interface gigabitethernet 0/0.300
 nameif shared
 security-level 50
 ip address 10.1.1.1 255.255.255.0
 no shutdown
passwd v00d00
enable password d011
route outside 0 0 209.165.201.2 1
nat (inside) 1 10.1.0.0 255.255.255.0
! This context uses PAT for inside users that access the outside
global (outside) 1 209.165.201.6 netmask 255.255.255.255
! This context uses PAT for inside users that access the shared network

```

### Example 3: Shared Resources for Multiple Contexts

```

global (shared) 1 10.1.1.30
! Because this host can access the web server in the Department 1 context, it requires a
! static translation
static (inside,outside) 209.165.201.7 10.1.0.15 netmask 255.255.255.255
! Because this host has management access to the servers on the Shared interface, it
! requires a static translation to be used in an access list
static (inside,shared) 10.1.1.78 10.1.0.15 netmask 255.255.255.255
access-list SHARED remark -Allows only mail traffic from inside to exit shared interface
access-list SHARED remark -but allows the admin host to access any server.
access-list SHARED extended permit ip host 10.1.1.78 any
access-list SHARED extended permit tcp host 10.1.1.30 host 10.1.1.7 eq smtp
! Note that the translated addresses are used.
access-group SHARED out interface shared
! Allows 10.1.0.15 to access the admin context using Telnet. From the admin context, you
! can access all other contexts.
telnet 10.1.0.15 255.255.255.255 inside
aaa-server AAA-SERVER protocol tacacs+
aaa-server AAA-SERVER (shared) host 10.1.1.6
 key TheUauthKey
! The host at 10.1.0.15 must authenticate with the AAA server to log in
aaa authentication telnet console AAA-SERVER
logging trap 6
! System messages are sent to the syslog server on the Shared network
logging host shared 10.1.1.8
logging on

```

### Example 3: Department 1 Context Configuration

```

interface gigabitethernet 0/0.200
 nameif outside
 security-level 0
 ip address 209.165.201.4 255.255.255.224
 no shutdown
interface gigabitethernet 0/0.202
 nameif inside
 security-level 100
 ip address 10.1.2.1 255.255.255.0
 no shutdown
interface gigabitethernet 0/0.300
 nameif shared
 security-level 50
 ip address 10.1.1.2 255.255.255.0
 no shutdown
passwd cugel
enable password rhalto
nat (inside) 1 10.1.2.0 255.255.255.0
! The inside network uses PAT when accessing the outside
global (outside) 1 209.165.201.8 netmask 255.255.255.255
! The inside network uses dynamic NAT when accessing the shared network
global (shared) 1 10.1.1.31-10.1.1.37
! The web server can be accessed from outside and requires a static translation
static (inside,outside) 209.165.201.9 10.1.2.3 netmask 255.255.255.255
access-list WEBSERVER remark -Allows the management host (its translated address) on the
access-list WEBSERVER remark -admin context to access the web server for management
access-list WEBSERVER remark -it can use any IP protocol
access-list WEBSERVER extended permit ip host 209.165.201.7 host 209.165.201.9
access-list WEBSERVER remark -Allows any outside address to access the web server
access-list WEBSERVER extended permit tcp any eq http host 209.165.201.9 eq http
access-group WEBSERVER in interface outside
access-list MAIL remark -Allows only mail traffic from inside to exit out the shared int
! Note that the translated addresses are used.

```

```

access-list MAIL extended permit tcp host 10.1.1.31 eq smtp host 10.1.1.7 eq smtp
access-list MAIL extended permit tcp host 10.1.1.32 eq smtp host 10.1.1.7 eq smtp
access-list MAIL extended permit tcp host 10.1.1.33 eq smtp host 10.1.1.7 eq smtp
access-list MAIL extended permit tcp host 10.1.1.34 eq smtp host 10.1.1.7 eq smtp
access-list MAIL extended permit tcp host 10.1.1.35 eq smtp host 10.1.1.7 eq smtp
access-list MAIL extended permit tcp host 10.1.1.36 eq smtp host 10.1.1.7 eq smtp
access-list MAIL extended permit tcp host 10.1.1.37 eq smtp host 10.1.1.7 eq smtp
access-group MAIL out interface shared
aaa-server AAA-SERVER protocol tacacs+
aaa-server AAA-SERVER (shared) host 10.1.1.6
 key TheUauthKey
! All traffic matching the WEBSERVER access list must authenticate with the AAA server
aaa authentication match WEBSERVER outside AAA-SERVER
logging trap 4
! System messages are sent to the syslog server on the Shared network
logging host shared 10.1.1.8
logging on

```

### Example 3: Department 2 Context Configuration

```

interface gigabitethernet 0/0.200
 nameif outside
 security-level 0
 ip address 209.165.201.5 255.255.255.224
 no shutdown
interface gigabitethernet 0/0.203
 nameif inside
 security-level 100
 ip address 10.1.3.1 255.255.255.0
 no shutdown
interface gigabitethernet 0/0.300
 nameif shared
 security-level 50
 ip address 10.1.1.3 255.255.255.0
 no shutdown
passwd mazlrlan
enable password ly0ne$$e
route outside 0 0 209.165.201.2 1
nat (inside) 1 10.1.3.0 255.255.255.0
! The inside network uses PAT when accessing the outside
global (outside) 1 209.165.201.10 netmask 255.255.255.255
! The inside network uses PAT when accessing the shared network
global (shared) 1 10.1.1.38
access-list MAIL remark -Allows only mail traffic from inside to exit out the shared int
access-list MAIL extended permit tcp host 10.1.1.38 host 10.1.1.7 eq smtp
! Note that the translated PAT address is used.
access-group MAIL out interface shared
logging trap 3
! System messages are sent to the syslog server on the Shared network
logging host shared 10.1.1.8
logging on

```

## Example 4: Multiple Mode, Transparent Firewall with Outside Access

This configuration creates three security contexts plus the admin context. Each context allows OSPF traffic to pass between the inside and outside routers (see [Figure B-4](#)).

Inside hosts can access the Internet through the outside, but no outside hosts can access the inside.

The admin context allows SSH sessions to the security appliance from one host.

Although inside IP addresses can be the same across contexts, keeping them unique is easier to manage.

**Figure B-4** Example 4

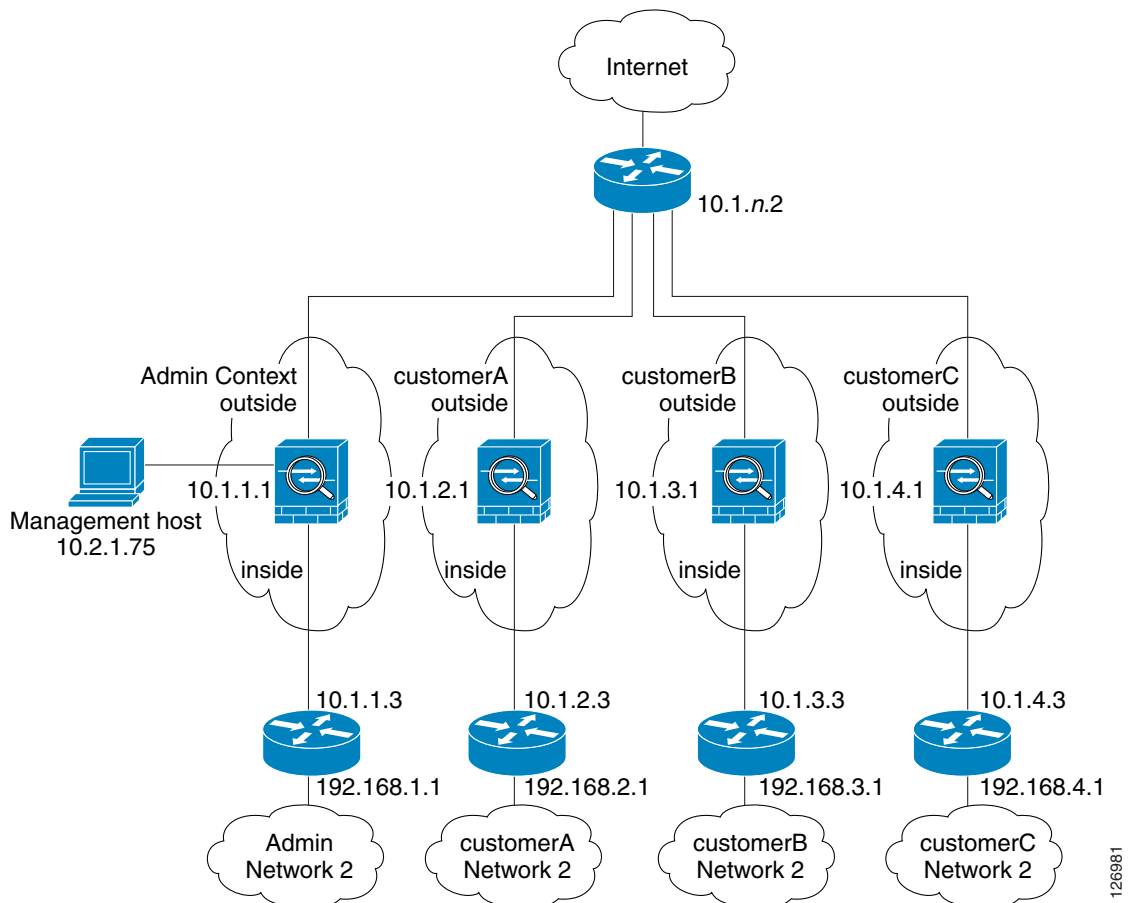

See the following sections for the configurations for this scenario:

- [Example 4: System Configuration, page 13](#)
- [Example 4: Admin Context Configuration, page 14](#)
- [Example 4: Customer A Context Configuration, page 14](#)
- [Example 4: Customer B Context Configuration, page 14](#)
- [Example 4: Customer C Context Configuration, page 15](#)

## Example 4: System Configuration

You must first enable multiple context mode using the **mode multiple** command. The mode is not stored in the configuration file, even though it endures reboots. If you view the configuration on the security appliance using the **write terminal**, **show startup-config**, or **show running-config** commands, the mode displays after the security appliance version (blank means single mode, “<system>” means you are in multiple mode in the system configuration, and <context> means you are in multiple mode in a context).

```
firewall transparent
hostname Farscape
password passw0rd
enable password chr1cht0n
admin-context admin
interface gigabitethernet 0/0
 no shutdown
interface gigabitethernet 0/0.150
 vlan 150
 no shutdown
interface gigabitethernet 0/0.151
 vlan 151
 no shutdown
interface gigabitethernet 0/0.152
 vlan 152
 no shutdown
interface gigabitethernet 0/0.153
 vlan 153
 no shutdown
interface gigabitethernet 0/1
 shutdown
interface gigabitethernet 0/1.4
 vlan 4
 no shutdown
interface gigabitethernet 0/1.5
 vlan 5
 no shutdown
interface gigabitethernet 0/1.6
 vlan 6
 no shutdown
interface gigabitethernet 0/1.7
 vlan 7
 no shutdown
context admin
 allocate-interface gigabitethernet 0/0.150
 allocate-interface gigabitethernet 0/1.4
 config-url disk0://admin.cfg
context customerA
 description This is the context for customer A
 allocate-interface gigabitethernet 0/0.151
 allocate-interface gigabitethernet 0/1.5
 config-url disk0://contexta.cfg
context customerB
 description This is the context for customer B
 allocate-interface gigabitethernet 0/0.152
 allocate-interface gigabitethernet 0/1.6
 config-url disk0://contextb.cfg
context customerC
 description This is the context for customer C
 allocate-interface gigabitethernet 0/0.153
 allocate-interface gigabitethernet 0/1.7
 config-url disk0://contextc.cfg
```

## Example 4: Admin Context Configuration

The host at 10.1.1.75 can access the context using SSH, which requires a key pair to be generated using the **crypto key generate** command.

```
hostname Admin
domain isp
interface gigabitethernet 0/0.150
 nameif outside
 security-level 0
 no shutdown
interface gigabitethernet 0/1.4
 nameif inside
 security-level 100
 no shutdown
passwd secret1969
enable password h1and10
ip address 10.1.1.1 255.255.255.0
route outside 0 0 10.1.1.2 1
ssh 10.1.1.75 255.255.255.255 inside
access-list OSPF remark -Allows OSPF
access-list OSPF extended permit 89 any any
access-group OSPF in interface outside
```

## Example 4: Customer A Context Configuration

```
interface gigabitethernet 0/0.151
 nameif outside
 security-level 0
 no shutdown
interface gigabitethernet 0/1.5
 nameif inside
 security-level 100
 no shutdown
passwd hell0!
enable password enter55
ip address 10.1.2.1 255.255.255.0
route outside 0 0 10.1.2.2 1
access-list OSPF remark -Allows OSPF
access-list OSPF extended permit 89 any any
access-group OSPF in interface outside
```

## Example 4: Customer B Context Configuration

```
interface gigabitethernet 0/0.152
 nameif outside
 security-level 0
 no shutdown
interface gigabitethernet 0/1.6
 nameif inside
 security-level 100
 no shutdown
passwd tenac10us
enable password defen$e
ip address 10.1.3.1 255.255.255.0
route outside 0 0 10.1.3.2 1
access-list OSPF remark -Allows OSPF
```



```
access-list OSPF extended permit 89 any any
access-group OSPF in interface outside
```

## Example 4: Customer C Context Configuration

```
interface gigabitethernet 0/0.153
 nameif outside
 security-level 0
 no shutdown
interface gigabitethernet 0/1.7
 nameif inside
 security-level 100
 no shutdown
passwd fl0wer
enable password treeh0u$e
ip address 10.1.4.1 255.255.255.0
route outside 0 0 10.1.4.2 1
access-list OSPF remark -Allows OSPF
access-list OSPF extended permit 89 any any
access-group OSPF in interface outside
```

## Example 5: WebVPN Configuration

This configuration shows the commands needed to create WebVPN connections to the security appliance.

WebVPN lets users establish a secure, remote-access VPN tunnel to the security appliance using a web browser. There is no need for either a software or hardware client. WebVPN provides easy access to a broad range of web resources and web-enabled applications from almost any computer that can reach HTTP(S) Internet sites. WebVPN uses Secure Socket Layer Protocol and its successor, Transport Layer Security (SSL/TLS1) to provide a secure connection between remote users and specific, supported internal resources that you configure at a central site. The security appliance recognizes connections that need to be proxied, and the HTTP server interacts with the authentication subsystem to authenticate users.

---

### Step 1 Configure the security appliance for WebVPN.

```
webvpn
! WebVPN sessions are allowed on the outside and dmz1 interfaces, ASDM is not allowed.
enable outside
enable dmz161
title-color green
secondary-color 200,160,0
text-color black
default-idle-timeout 3600
! The NetBios Name server used for CIFS resolution.
nbns-server 172.31.122.10 master timeout 2 retry 2
accounting-server-group RadiusACS1
! WebVPN sessions are authenticated to a RADIUS aaa server.
authentication-server-group RadiusACS2
```

### Step 2 You must enable WebVPN access lists to be enforced on a group-policy or user policy. The access lists are defined with the **filter value** and **functions** commands in the group or user configuration.

```
access-list maia2 remark -deny access to url and send a syslog every 300 seconds
```

## Example 5: WebVPN Configuration

```

access-list maia2 remark -containing the hit-count (how many times the url was accessed)
access-list maia2 webtype deny url https://sales.example.com log informational interval
300
access-list maia2 remark -Permits access to the URL.
access-list maia2 webtype permit url http://employee-connection.example.com
access-list maia2 remark -Permits access to the site using ssh.
access-list maia2 remark -To be enforced via Port-Forwarding application.
access-list maia2 webtype permit tcp asa-35.example.com 255.255.255.255 eq ssh
access-list maia2 remark -Denies access to the application on port 1533.
access-list maia2 webtype deny tcp im.example.com 255.255.255.255 eq 1533
access-list maia2 remark -Permits access to files on this file share via
access-list maia2 remark -WebVPN Common Internet File System (CIFS).
access-list maia2 webtype permit url cifs://server-bos/people/mkting log informational
3600

```

- Step 3** You can configure a list of pre-configured URLs presented on the WebVPN user's home page after login, which are defined per user or per group.

```

url-list HomeURL "Sales" https://sales.example.com
url-list HomeURL "VPN3000-1" http://vpn3k-1.example.com
url-list HomeURL "OWA-2000" http://10.160.105.2/exchange
url-list HomeURL "Exchange5.5" http://10.86.195.113/exchange
url-list HomeURL " Employee Benefits" http://benefits.example.com
url-list HomeURL "Calendar" http://http://eng.example.com/cal.html

```

- Step 4** Configure a list of non-web TCP applications that will be port-forwarded over WebVPN and enforced per user or per group-policy. These are defined globally but can be enforced per user or per group-policy.

```

port-forward Apps1 4001 10.148.1.81 telnet term-servr
port-forward Apps1 4008 router1-example.com ssh
port-forward Apps1 10143 flask.example.com imap4
port-forward Apps1 10110 flask.example.com pop3
port-forward Apps1 10025 flask.example.com smtp
port-forward Apps1 11533 sametime-im.example.com 1533
port-forward Apps1 10022 secure-term.example.com ssh
port-forward Apps1 21666 tuscan.example.com 1666 performce-f1
port-forward Apps1 1030 sales.example.com https

```

- Step 5** Configure the policy attributes enforced for users of the SSLVPNusers group-policy.

```

group-policy SSLVPNusers internal
group-policy SSLVPNusers attributes
 banner value Welcome to Web Services !!!
 vpn-idle-timeout 2
 vpn-tunnel-protocol IPSec webvpn
 webvpn
 functions url-entry file-access file-entry file-browsing port-forward filter
 url-list value HomeURL
 port-forward value Apps1

```

- Step 6** Next, configure the interface(s) where ASDM and WebVPN HTTPS sessions will terminate. Note that simultaneous ASDM/WebVPN use on the same interface is not supported.

```

! Enables the HTTP server to allow ASDM and WebVPN HTTPS sessions.
http server enable
! Allows ASDM session(s) from host 10.20.30.47 on the inside interface ; WebVPN sessions
! are not allowed on this interface.
http 10.10.10.45 inside
! Allows WebVPN sessions on outside interface using HTTP to be re-directed to HTTPS.
! ASDM session is not allowed on this interface.
http redirect outside 80
! Allows WebVPN sessions on dmz1 interfce using HTTP to be re-directed to HTTPS.
! ASDM session is not allowed on this interface.
http redirect dmz161 80

```

- Step 7** Next, allow HTTPS ASDM and WebVPN sessions to terminate on the security appliance using the 3DES-sha1 cipher. Requires that a proper 3DES activation-key be previously installed.

```
ssl encryption 3des-sha1
ssl trust-point CA-MS inside
```

- Step 8** Finally, configure the email proxy settings.

```
imap4s
 enable outside
 enable inside
 enable dmz161
 default-group-policy DfltGrpPolicy
pop3s
 enable outside
 enable inside
 enable dmz161
 default-group-policy DfltGrpPolicy
smtps
 enable outside
 enable inside
 enable dmz161
 default-group-policy DfltGrpPolicy
```





## Using the Command-Line Interface

---

This appendix describes how to use the CLI on the security appliance, and includes the following sections:

- [Firewall Mode and Security Context Mode, page C-1](#)
- [Command Modes and Prompts, page C-2](#)
- [Syntax Formatting, page C-3](#)
- [Abbreviating Commands, page C-3](#)
- [Command-Line Editing, page C-3](#)
- [Command Completion, page C-3](#)
- [Command Help, page C-4](#)
- [Filtering show Command Output, page C-4](#)
- [Command Output Paging, page C-5](#)
- [Adding Comments, page C-5](#)
- [Text Configuration Files, page C-6](#)



**Note**

---

The CLI uses similar syntax and other conventions to the Cisco IOS CLI, but the security appliance operating system is not a version of Cisco IOS software. Do not assume that a Cisco IOS CLI command works with or has the same function on the security appliance.

---

## Firewall Mode and Security Context Mode

The security appliance runs in a combination of the following modes:

- **Transparent firewall or routed firewall mode**  
The firewall mode determines if the security appliance runs as a Layer 2 or Layer 3 firewall.
- **Multiple context or single context mode**  
The security context mode determines if the security appliance runs as a single device or as multiple security contexts, which act like virtual devices.

Some commands are only available in certain modes.

# Command Modes and Prompts

The security appliance CLI includes command modes. Some commands can only be entered in certain modes. For example, to enter commands that show sensitive information, you need to enter a password and enter a more privileged mode. Then, to ensure that configuration changes are not entered accidentally, you have to enter a configuration mode. All lower commands can be entered in higher modes, for example, you can enter a privileged EXEC command in global configuration mode.

When you are in the system configuration or in single context mode, the prompt begins with the hostname:

```
hostname
```

When you are within a context, the prompt begins with the hostname followed by the context name:

```
hostname/context
```

The prompt changes depending on the access mode:

- User EXEC mode

User EXEC mode lets you see minimum security appliance settings. The user EXEC mode prompt appears as follows when you first access the security appliance:

```
hostname>
```

```
hostname/context>
```

- Privileged EXEC mode

Privileged EXEC mode lets you see all current settings up to your privilege level. Any user EXEC mode command will work in privileged EXEC mode. Enter the **enable** command in user EXEC mode, which requires a password, to start privileged EXEC mode. The prompt includes the number sign (#):

```
hostname#
```

```
hostname/context#
```

- Global configuration mode

Global configuration mode lets you change the security appliance configuration. All user EXEC, privileged EXEC, and global configuration commands are available in this mode. Enter the **configure terminal** command in privileged EXEC mode to start global configuration mode. The prompt changes to the following:

```
hostname(config)#
```

```
hostname/context(config)#
```

- Command-specific configuration modes

From global configuration mode, some commands enter a command-specific configuration mode. All user EXEC, privileged EXEC, global configuration, and command-specific configuration commands are available in this mode. For example, the **interface** command enters interface configuration mode. The prompt changes to the following:

```
hostname(config-if)#
```

```
hostname/context(config-if)#
```

# Syntax Formatting

Command syntax descriptions use the following conventions:

**Table C-1**      **Syntax Conventions**

| Convention     | Description                                                                                                                                                                                                                  |
|----------------|------------------------------------------------------------------------------------------------------------------------------------------------------------------------------------------------------------------------------|
| <b>bold</b>    | Bold text indicates commands and keywords that you enter literally as shown.                                                                                                                                                 |
| <i>italics</i> | Italic text indicates arguments for which you supply values.                                                                                                                                                                 |
| [x]            | Square brackets enclose an optional element (keyword or argument).                                                                                                                                                           |
|                | A vertical bar indicates a choice within an optional or required set of keywords or arguments.                                                                                                                               |
| [x   y]        | Square brackets enclosing keywords or arguments separated by a vertical bar indicate an optional choice.                                                                                                                     |
| {x   y}        | Braces enclosing keywords or arguments separated by a vertical bar indicate a required choice.                                                                                                                               |
| [x {y   z}]    | Nested sets of square brackets or braces indicate optional or required choices within optional or required elements. Braces and a vertical bar within square brackets indicate a required choice within an optional element. |

## Abbreviating Commands

You can abbreviate most commands down to the fewest unique characters for a command; for example, you can enter **wr t** to view the configuration instead of entering the full command **write terminal**, or you can enter **en** to start privileged mode and **conf t** to start configuration mode. In addition, you can enter **0** to represent **0.0.0.0**.

## Command-Line Editing

The security appliance uses the same command-line editing conventions as Cisco IOS software. You can view all previously entered commands with the **show history** command or individually with the up arrow or **^p** command. Once you have examined a previously entered command, you can move forward in the list with the down arrow or **^n** command. When you reach a command you wish to reuse, you can edit it or press the **Enter** key to start it. You can also delete the word to the left of the cursor with **^w**, or erase the line with **^u**.

The security appliance permits up to 512 characters in a command; additional characters are ignored.

## Command Completion

To complete a command or keyword after entering a partial string, press the **Tab** key. The security appliance only completes the command or keyword if the partial string matches only one command or keyword. For example, if you enter **s** and press the **Tab** key, the security appliance does not complete the command because it matches more than one command. However, if you enter **dis**, the **Tab** key completes the command **disable**.

# Command Help

Help information is available from the command line by entering the following commands:

- **help** *command\_name*  
Shows help for the specific command.
- *command\_name* ?  
Shows a list of arguments available.
- *string?* (no space)  
Lists the possible commands that start with the string.
- ? and +?  
Lists all commands available. If you enter ?, the security appliance shows only commands available for the current mode. To show all commands available, including those for lower modes, enter +?.

**Note**

If you want to include a question mark (?) in a command string, you must press **Ctrl-V** before typing the question mark so you do not inadvertently invoke CLI help.

## Filtering show Command Output

You can use the vertical bar (|) with any **show** command and include a filter option and filtering expression. The filtering is performed by matching each output line with a regular expression, similar to Cisco IOS software. By selecting different filter options you can include or exclude all output that matches the expression. You can also display all output beginning with the line that matches the expression.

The syntax for using filtering options with the **show** command is as follows:

```
hostname# show command | {include | exclude | begin | grep [-v]} regex
```

In this command string, the first vertical bar (|) is the operator and must be included in the command. This operator directs the output of the **show** command to the filter. In the syntax diagram, the other vertical bars (|) indicate alternative options and are not part of the command.

The **include** option includes all output lines that match the regular expression. The **grep** option without **-v** has the same effect. The **exclude** option excludes all output lines that match the regular expression. The **grep** option with **-v** has the same effect. The **begin** option shows all the output lines starting with the line that matches the regular expression.

Replace *regex* with any Cisco IOS regular expression. See The regular expression is not enclosed in quotes or double-quotes, so be careful with trailing white spaces, which will be taken as part of the regular expression.

When creating regular expressions, you can use any letter or number that you want to match. In addition, certain keyboard characters have special meaning when used in regular expressions. [Table C-2](#) lists the keyboard characters that have special meaning.



**Table C-2** Using Special Characters in Regular Expressions

| Character Type | Character      | Special Meaning                                                                                                                                                         |
|----------------|----------------|-------------------------------------------------------------------------------------------------------------------------------------------------------------------------|
| period         | .              | Matches any single character, including white space.                                                                                                                    |
| asterisk       | *              | Matches 0 or more sequences of the pattern.                                                                                                                             |
| plus sign      | +              | Matches 1 or more sequences of the pattern.                                                                                                                             |
| question mark  | ? <sup>1</sup> | Matches 0 or 1 occurrences of the pattern.                                                                                                                              |
| caret          | ^              | Matches the beginning of the input string.                                                                                                                              |
| dollar sign    | \$             | Matches the end of the input string.                                                                                                                                    |
| underscore     | _              | Matches a comma (,), left brace ({}), right brace (}), left parenthesis, right parenthesis, the beginning of the input string, the end of the input string, or a space. |
| brackets       | []             | Designates a range of single-character patterns.                                                                                                                        |
| hyphen         | -              | Separates the end points of a range.                                                                                                                                    |

1. Precede the question mark with **Ctrl-V** to prevent the question mark from being interpreted as a help command.

To use these special characters as single-character patterns, remove the special meaning by preceding each character with a backslash (\).

## Command Output Paging

On commands such as **help** or **?**, **show**, **show xlate**, or other commands that provide long listings, you can determine if the information displays a screen and pauses, or lets the command run to completion. The **pager** command lets you choose the number of lines to display before the More prompt appears.

When paging is enabled, the following prompt appears:

```
<--- More --->
```

The More prompt uses syntax similar to the UNIX **more** command:

- To view another screen, press the Space bar.
- To view the next line, press the **Enter** key.
- To return to the command line, press the **q** key.

## Adding Comments

You can precede a line with a colon (:) to create a comment. However, the comment only appears in the command history buffer and not in the configuration. Therefore, you can view the comment with the **show history** command or by pressing an arrow key to retrieve a previous command, but because the comment is not in the configuration, the **write terminal** command does not display it.

# Text Configuration Files

This section describes how to format a text configuration file that you can download to the security appliance, and includes the following topics:

- [How Commands Correspond with Lines in the Text File, page C-6](#)
- [Command-Specific Configuration Mode Commands, page C-6](#)
- [Automatic Text Entries, page C-6](#)
- [Line Order, page C-7](#)
- [Commands Not Included in the Text Configuration, page C-7](#)
- [Passwords, page C-7](#)
- [Multiple Security Context Files, page C-7](#)

## How Commands Correspond with Lines in the Text File

The text configuration file includes lines that correspond with the commands described in this guide.

In examples, commands are preceded by a CLI prompt. The prompt in the following example is “hostname(config)#”:

```
hostname(config)# context a
```

In the text configuration file you are not prompted to enter commands, so the prompt is omitted:

```
context a
```

## Command-Specific Configuration Mode Commands

Command-specific configuration mode commands appear indented under the main command when entered at the command line. Your text file lines do not need to be indented, as long as the commands appear directly following the main command. For example, the following unindented text is read the same as indented text:

```
interface gigabitethernet0/0
nameif inside
interface gigabitethernet0/1
 nameif outside
```

## Automatic Text Entries

When you download a configuration to the security appliance, the security appliance inserts some lines automatically. For example, the security appliance inserts lines for default settings or for the time the configuration was modified. You do not need to enter these automatic entries when you create your text file.

## Line Order

For the most part, commands can be in any order in the file. However, some lines, such as ACEs, are processed in the order they appear, and the order can affect the function of the access list. Other commands might also have order requirements. For example, you must enter the **nameif** command for an interface first because many subsequent commands use the name of the interface. Also, commands in a command-specific configuration mode must directly follow the main command.

## Commands Not Included in the Text Configuration

Some commands do not insert lines in the configuration. For example, a runtime command such as **show running-config** does not have a corresponding line in the text file.

## Passwords

The login, enable, and user passwords are automatically encrypted before they are stored in the configuration. For example, the encrypted form of the password “cisco” might look like jMorNbK0514fadBh. You can copy the configuration passwords to another security appliance in their encrypted form, but you cannot unencrypt the passwords yourself.

If you enter an unencrypted password in a text file, the security appliance does not automatically encrypt them when you copy the configuration to the security appliance. The security appliance only encrypts them when you save the running configuration from the command line using the **copy running-config startup-config** or **write memory** command.

## Multiple Security Context Files

For multiple security contexts, the entire configuration consists of multiple parts:

- The security context configurations
- The system configuration, which identifies basic settings for the security appliance, including a list of contexts
- The admin context, which provides network interfaces for the system configuration

The system configuration does not include any interfaces or network settings for itself. Rather, when the system needs to access network resources (such as downloading the contexts from the server), it uses a context that is designated as the admin context.

Each context is similar to a single context mode configuration. The system configuration differs from a context configuration in that the system configuration includes system-only commands (such as a list of all contexts) while other typical commands are not present (such as many interface parameters).





## Addresses, Protocols, and Ports

---

This appendix provides a quick reference for IP addresses, protocols, and applications. This appendix includes the following sections:

- [IPv4 Addresses and Subnet Masks, page D-1](#)
- [IPv6 Addresses, page D-5](#)
- [Protocols and Applications, page D-11](#)
- [TCP and UDP Ports, page D-12](#)
- [Local Ports and Protocols, page D-14](#)
- [ICMP Types, page D-15](#)

### IPv4 Addresses and Subnet Masks

This section describes how to use IPv4 addresses in the security appliance. An IPv4 address is a 32-bit number written in dotted-decimal notation: four 8-bit fields (octets) converted from binary to decimal numbers, separated by dots. The first part of an IP address identifies the network on which the host resides, while the second part identifies the particular host on the given network. The network number field is called the network prefix. All hosts on a given network share the same network prefix but must have a unique host number. In classful IP, the class of the address determines the boundary between the network prefix and the host number.

This section includes the following topics:

- [Classes, page D-2](#)
- [Private Networks, page D-2](#)
- [Subnet Masks, page D-2](#)

## Classes

IP host addresses are divided into three different address classes: Class A, Class B, and Class C. Each class fixes the boundary between the network prefix and the host number at a different point within the 32-bit address. Class D addresses are reserved for multicast IP.

- Class A addresses (1.xxx.xxx.xxx through 126.xxx.xxx.xxx) use only the first octet as the network prefix.
- Class B addresses (128.0.xxx.xxx through 191.255.xxx.xxx) use the first two octets as the network prefix.
- Class C addresses (192.0.0.xxx through 223.255.255.xxx) use the first three octets as the network prefix.

Because Class A addresses have 16,777,214 host addresses, and Class B addresses 65,534 hosts, you can use subnet masking to break these huge networks into smaller subnets.

## Private Networks

If you need large numbers of addresses on your network, and they do not need to be routed on the Internet, you can use private IP addresses that the Internet Assigned Numbers Authority (IANA) recommends (see RFC 1918). The following address ranges are designated as private networks that should not be advertised:

- 10.0.0.0 through 10.255.255.255
- 172.16.0.0 through 172.31.255.255
- 192.168.0.0 through 192.168.255.255

## Subnet Masks

A subnet mask lets you convert a single Class A, B, or C network into multiple networks. With a subnet mask, you can create an extended network prefix that adds bits from the host number to the network prefix. For example, a Class C network prefix always consists of the first three octets of the IP address. But a Class C extended network prefix uses part of the fourth octet as well.

Subnet masking is easy to understand if you use binary notation instead of dotted decimal. The bits in the subnet mask have a one-to-one correspondence with the Internet address:

- The bits are set to 1 if the corresponding bit in the IP address is part of the extended network prefix.
- The bits are set to 0 if the bit is part of the host number.

**Example 1:** If you have the Class B address 129.10.0.0 and you want to use the entire third octet as part of the extended network prefix instead of the host number, you must specify a subnet mask of 11111111.11111111.11111111.00000000. This subnet mask converts the Class B address into the equivalent of a Class C address, where the host number consists of the last octet only.

**Example 2:** If you want to use only part of the third octet for the extended network prefix, then you must specify a subnet mask like 11111111.11111111.11111000.00000000, which uses only 5 bits of the third octet for the extended network prefix.

You can write a subnet mask as a dotted-decimal mask or as a */bits* (“slash *bits*”) mask. In Example 1, for a dotted-decimal mask, you convert each binary octet into a decimal number: 255.255.255.0. For a */bits* mask, you add the number of 1s: /24. In Example 2, the decimal number is 255.255.248.0 and the */bits* is /21.

You can also supernet multiple Class C networks into a larger network by using part of the third octet for the extended network prefix. For example, 192.168.0.0/20.

This section includes the following topics:

- [Determining the Subnet Mask, page D-3](#)
- [Determining the Address to Use with the Subnet Mask, page D-3](#)

## Determining the Subnet Mask

To determine the subnet mask based on how many hosts you want, see [Table D-1](#).

**Table D-1** *Hosts, Bits, and Dotted-Decimal Masks*

| Hosts <sup>1</sup> | /Bits Mask | Dotted-Decimal Mask                 |
|--------------------|------------|-------------------------------------|
| 16,777,216         | /8         | 255.0.0.0 Class A Network           |
| 65,536             | /16        | 255.255.0.0 Class B Network         |
| 32,768             | /17        | 255.255.128.0                       |
| 16,384             | /18        | 255.255.192.0                       |
| 8192               | /19        | 255.255.224.0                       |
| 4096               | /20        | 255.255.240.0                       |
| 2048               | /21        | 255.255.248.0                       |
| 1024               | /22        | 255.255.252.0                       |
| 512                | /23        | 255.255.254.0                       |
| 256                | /24        | 255.255.255.0 Class C Network       |
| 128                | /25        | 255.255.255.128                     |
| 64                 | /26        | 255.255.255.192                     |
| 32                 | /27        | 255.255.255.224                     |
| 16                 | /28        | 255.255.255.240                     |
| 8                  | /29        | 255.255.255.248                     |
| 4                  | /30        | 255.255.255.252                     |
| Do not use         | /31        | 255.255.255.254                     |
| 1                  | /32        | 255.255.255.255 Single Host Address |

1. The first and last number of a subnet are reserved, except for /32, which identifies a single host.

## Determining the Address to Use with the Subnet Mask

The following sections describe how to determine the network address to use with a subnet mask for a Class C-size and a Class B-size network. This section includes the following topics:

- [Class C-Size Network Address, page D-4](#)
- [Class B-Size Network Address, page D-4](#)

### Class C-Size Network Address

For a network between 2 and 254 hosts, the fourth octet falls on a multiple of the number of host addresses, starting with 0. For example, the 8-host subnets (/29) of 192.168.0.x are as follows:

| Subnet with Mask /29 (255.255.255.248) | Address Range <sup>1</sup>     |
|----------------------------------------|--------------------------------|
| 192.168.0.0                            | 192.168.0.0 to 192.168.0.7     |
| 192.168.0.8                            | 192.168.0.8 to 192.168.0.15    |
| 192.168.0.16                           | 192.168.0.16 to 192.168.0.31   |
| ...                                    | ...                            |
| 192.168.0.248                          | 192.168.0.248 to 192.168.0.255 |

1. The first and last address of a subnet are reserved. In the first subnet example, you cannot use 192.168.0.0 or 192.168.0.7.

### Class B-Size Network Address

To determine the network address to use with the subnet mask for a network with between 254 and 65,534 hosts, you need to determine the value of the third octet for each possible extended network prefix. For example, you might want to subnet an address like 10.1.x.0, where the first two octets are fixed because they are used in the extended network prefix, and the fourth octet is 0 because all bits are used for the host number.

To determine the value of the third octet, follow these steps:

- Step 1** Calculate how many subnets you can make from the network by dividing 65,536 (the total number of addresses using the third and fourth octet) by the number of host addresses you want.
- For example, 65,536 divided by 4096 hosts equals 16.
- Therefore, there are 16 subnets of 4096 addresses each in a Class B-size network.
- Step 2** Determine the multiple of the third octet value by dividing 256 (the number of values for the third octet) by the number of subnets:
- In this example,  $256/16 = 16$ .
- The third octet falls on a multiple of 16, starting with 0.
- Therefore, the 16 subnets of the network 10.1 are as follows:

| Subnet with Mask /20 (255.255.240.0) | Address Range <sup>1</sup> |
|--------------------------------------|----------------------------|
| 10.1.0.0                             | 10.1.0.0 to 10.1.15.255    |
| 10.1.16.0                            | 10.1.16.0 to 10.1.31.255   |
| 10.1.32.0                            | 10.1.32.0 to 10.1.47.255   |
| ...                                  | ...                        |
| 10.1.240.0                           | 10.1.240.0 to 10.1.255.255 |

1. The first and last address of a subnet are reserved. In the first subnet example, you cannot use 10.1.0.0 or 10.1.15.255.



# IPv6 Addresses

IPv6 is the next generation of the Internet Protocol after IPv4. It provides an expanded address space, a simplified header format, improved support for extensions and options, flow labeling capability, and authentication and privacy capabilities. IPv6 is described in RFC 2460. The IPv6 addressing architecture is described in RFC 3513.

This section describes the IPv6 address format and architecture and includes the following topics:

- [IPv6 Address Format, page D-5](#)
- [IPv6 Address Types, page D-6](#)
- [IPv6 Address Prefixes, page D-10](#)



## Note

This section describes the IPv6 address format, the types, and prefixes. For information about configuring the security appliance to use IPv6, see [Chapter 6, “Configuring Interface Parameters.”](#)

## IPv6 Address Format

IPv6 addresses are represented as a series of eight 16-bit hexadecimal fields separated by colons (:) in the format: x:x:x:x:x:x:x. The following are two examples of IPv6 addresses:

- 2001:0DB8:7654:3210:FEDC:BA98:7654:3210
- 2001:0DB8:0000:0000:0008:0800:200C:417A



## Note

The hexadecimal letters in IPv6 addresses are not case-sensitive.

It is not necessary to include the leading zeros in an individual field of the address. But each field must contain at least one digit. So the example address 2001:0DB8:0000:0000:0008:0800:200C:417A can be shortened to 2001:0DB8:0:0:8:800:200C:417A by removing the leading zeros from the third through sixth fields from the left. The fields that contained all zeros (the third and fourth fields from the left) were shortened to a single zero. The fifth field from the left had the three leading zeros removed, leaving a single 8 in that field, and the sixth field from the left had the one leading zero removed, leaving 800 in that field.

It is common for IPv6 addresses to contain several consecutive hexadecimal fields of zeros. You can use two colons (::) to compress consecutive fields of zeros at the beginning, middle, or end of an IPv6 address (the colons represent the successive hexadecimal fields of zeros). [Table D-2](#) shows several examples of address compression for different types of IPv6 address.

**Table D-2** IPv6 Address Compression Examples

| Address Type | Standard Form               | Compressed Form        |
|--------------|-----------------------------|------------------------|
| Unicast      | 2001:0DB8:0:0:0:BA98:0:3210 | 2001:0DB8::BA98:0:3210 |
| Multicast    | FF01:0:0:0:0:0:101          | FF01::101              |
| Loopback     | 0:0:0:0:0:0:1               | ::1                    |
| Unspecified  | 0:0:0:0:0:0:0               | ::                     |

**Note**

---

Two colons (::) can be used only once in an IPv6 address to represent successive fields of zeros.

---

An alternative form of the IPv6 format is often used when dealing with an environment that contains both IPv4 and IPv6 addresses. This alternative has the format `x:x:x:x:x:y.y.y.y`, where `x` represent the hexadecimal values for the six high-order parts of the IPv6 address and `y` represent decimal values for the 32-bit IPv4 part of the address (which takes the place of the remaining two 16-bit parts of the IPv6 address). For example, the IPv4 address 192.168.1.1 could be represented as the IPv6 address `0:0:0:0:0:FFFF:192.168.1.1`, or `::FFFF:192.168.1.1`.

## IPv6 Address Types

The following are the three main types of IPv6 addresses:

- **Unicast**—A unicast address is an identifier for a single interface. A packet sent to a unicast address is delivered to the interface identified by that address. An interface may have more than one unicast address assigned to it.
- **Multicast**—A multicast address is an identifier for a set of interfaces. A packet sent to a multicast address is delivered to all addresses identified by that address.
- **Anycast**—An anycast address is an identifier for a set of interfaces. Unlike a multicast address, a packet sent to an anycast address is only delivered to the “nearest” interface, as determined by the measure of distances for the routing protocol.

**Note**

---

There are no broadcast addresses in IPv6. Multicast addresses provide the broadcast functionality.

---

This section includes the following topics:

- [Unicast Addresses, page D-6](#)
- [Multicast Address, page D-8](#)
- [Anycast Address, page D-9](#)
- [Required Addresses, page D-10](#)

## Unicast Addresses

This section describes IPv6 unicast addresses. Unicast addresses identify an interface on a network node.

This section includes the following topics:

- [Global Address, page D-7](#)
- [Site-Local Address, page D-7](#)
- [Link-Local Address, page D-7](#)
- [IPv4-Compatible IPv6 Addresses, page D-7](#)
- [Unspecified Address, page D-8](#)
- [Loopback Address, page D-8](#)
- [Interface Identifiers, page D-8](#)

## Global Address

The general format of an IPv6 global unicast address is a global routing prefix followed by a subnet ID followed by an interface ID. The global routing prefix can be any prefix not reserved by another IPv6 address type (see [IPv6 Address Prefixes](#), page D-10, for information about the IPv6 address type prefixes).

All global unicast addresses, other than those that start with binary 000, have a 64-bit interface ID in the Modified EUI-64 format. See [Interface Identifiers](#), page D-8, for more information about the Modified EUI-64 format for interface identifiers.

Global unicast address that start with the binary 000 do not have any constraints on the size or structure of the interface ID portion of the address. One example of this type of address is an IPv6 address with an embedded IPv4 address (see [IPv4-Compatible IPv6 Addresses](#), page D-7).

## Site-Local Address

Site-local addresses are used for addressing within a site. They can be use to address an entire site without using a globally unique prefix. Site-local addresses have the prefix FEC0::/10, followed by a 54-bit subnet ID, and end with a 64-bit interface ID in the modified EUI-64 format.

Site-local Routers do not forward any packets that have a site-local address for a source or destination outside of the site. Therefore, site-local addresses can be considered private addresses.

## Link-Local Address

All interfaces are required to have at least one link-local address. You can configure multiple IPv6 addresses per interfaces, but only one link-local address.

A link-local address is an IPv6 unicast address that can be automatically configured on any interface using the link-local prefix FE80::/10 and the interface identifier in modified EUI-64 format. Link-local addresses are used in the neighbor discovery protocol and the stateless autoconfiguration process. Nodes with a link-local address can communicate; they do not need a site-local or globally unique address to communicate.

Routers do not forward any packets that have a link-local address for a source or destination. Therefore, link-local addresses can be considered private addresses.

## IPv4-Compatible IPv6 Addresses

There are two types of IPv6 addresses that can contain IPv4 addresses.

The first type is the “IPv4-compatibly IPv6 address.” The IPv6 transition mechanisms include a technique for hosts and routers to dynamically tunnel IPv6 packets over IPv4 routing infrastructure. IPv6 nodes that use this technique are assigned special IPv6 unicast addresses that carry a global IPv4 address in the low-order 32 bits. This type of address is termed an “IPv4-compatible IPv6 address” and has the format ::y.y.y.y, where y.y.y.y is an IPv4 unicast address.



### Note

The IPv4 address used in the “IPv4-compatible IPv6 address” must be a globally-unique IPv4 unicast address.

The second type of IPv6 address which holds an embedded IPv4 address is called the “IPv4-mapped IPv6 address.” This address type is used to represent the addresses of IPv4 nodes as IPv6 addresses. This type of address has the format ::FFFF:y.y.y.y, where y.y.y.y is an IPv4 unicast address.

## Unspecified Address

The unspecified address, 0:0:0:0:0:0, indicates the absence of an IPv6 address. For example, a newly initialized node on an IPv6 network may use the unspecified address as the source address in its packets until it receives its IPv6 address.

**Note**

---

The IPv6 unspecified address cannot be assigned to an interface. The unspecified IPv6 addresses must not be used as destination addresses in IPv6 packets or the IPv6 routing header.

---

## Loopback Address

The loopback address, 0:0:0:0:0:1, may be used by a node to send an IPv6 packet to itself. The loopback address in IPv6 functions the same as the loopback address in IPv4 (127.0.0.1).

**Note**

---

The IPv6 loopback address cannot be assigned to a physical interface. A packet that has the IPv6 loopback address as its source or destination address must remain within the node that created the packet. IPv6 routers do not forward packets that have the IPv6 loopback address as their source or destination address.

---

## Interface Identifiers

Interface identifiers in IPv6 unicast addresses are used to identify the interfaces on a link. They need to be unique within a subnet prefix. In many cases, the interface identifier is derived from the interface link-layer address. The same interface identifier may be used on multiple interfaces of a single node, as long as those interfaces are attached to different subnets.

For all unicast addresses, except those that start with the binary 000, the interface identifier is required to be 64 bits long and to be constructed in the Modified EUI-64 format. The Modified EUI-64 format is created from the 48-bit MAC address by inverting the universal/local bit in the address and by inserting the hexadecimal number FFFE between the upper three bytes and lower three bytes of the of the MAC address.

For example, an interface with the MAC address of 00E0.b601.3B7A would have a 64-bit interface ID of 02E0:B6FF:FE01:3B7A.

## Multicast Address

An IPv6 multicast address is an identifier for a group of interfaces, typically on different nodes. A packet sent to a multicast address is delivered to all interfaces identified by the multicast address. An interface may belong to any number of multicast groups.

An IPv6 multicast address has a prefix of FF00::/8 (1111 1111). The octet following the prefix defines the type and scope of the multicast address. A permanently assigned (“well known”) multicast address has a flag parameter equal to 0; a temporary (“transient”) multicast address has a flag parameter equal to 1. A multicast address that has the scope of a node, link, site, or organization, or a global scope has a scope parameter of 1, 2, 5, 8, or E, respectively. For example, a multicast address with the prefix FF02::/16 is a permanent multicast address with a link scope. [Figure D-1](#) shows the format of the IPv6 multicast address.

Figure D-1 IPv6 Multicast Address Format

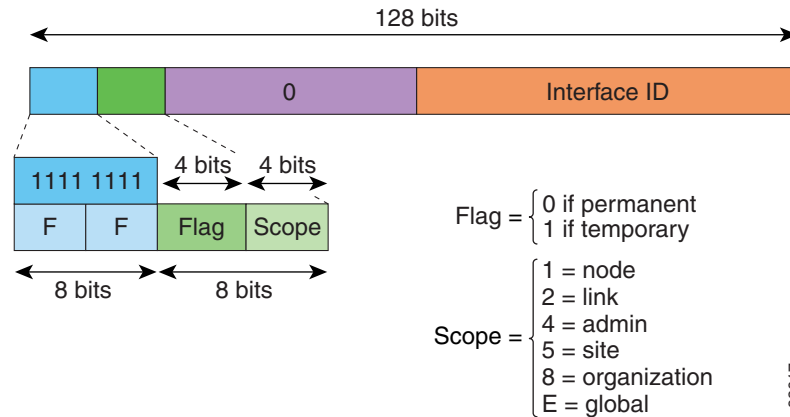

IPv6 nodes (hosts and routers) are required to join the following multicast groups:

- The All Nodes multicast addresses:
  - FF01:: (interface-local)
  - FF02:: (link-local)
- The Solicited-Node Address for each IPv6 unicast and anycast address on the node:  
FF02:0:0:0:1:FFXX:XXXX/104, where XX:XXXX is the low-order 24-bits of the unicast or anycast address.



**Note** Solicited-Node addresses are used in Neighbor Solicitation messages.

IPv6 routers are required to join the following multicast groups:

- FF01::2 (interface-local)
- FF02::2 (link-local)
- FF05::2 (site-local)

Multicast address should not be used as source addresses in IPv6 packets.



**Note** There are no broadcast addresses in IPv6. IPv6 multicast addresses are used instead of broadcast addresses.

## Anycast Address

The IPv6 anycast address is a unicast address that is assigned to more than one interface (typically belonging to different nodes). A packet that is routed to an anycast address is routed to the nearest interface having that address, the nearness being determined by the routing protocol in effect.

Anycast addresses are allocated from the unicast address space. An anycast address is simply a unicast address that has been assigned to more than one interface, and the interfaces must be configured to recognize the address as an anycast address.

The following restrictions apply to anycast addresses:

- An anycast address cannot be used as the source address for an IPv6 packet.
- An anycast address cannot be assigned to an IPv6 host; it can only be assigned to an IPv6 router.

**Note**

Anycast addresses are not supported on the security appliance.

## Required Addresses

IPv6 hosts must, at a minimum, be configured with the following addresses (either automatically or manually):

- A link-local address for each interface.
- The loopback address.
- The All-Nodes multicast addresses
- A Solicited-Node multicast address for each unicast or anycast address.

IPv6 routers must, at a minimum, be configured with the following addresses (either automatically or manually):

- The required host addresses.
- The Subnet-Router anycast addresses for all interfaces for which it is configured to act as a router.
- The All-Routers multicast addresses.

## IPv6 Address Prefixes

An IPv6 address prefix, in the format `ipv6-prefix/prefix-length`, can be used to represent bit-wise contiguous blocks of the entire address space. The IPv6-prefix must be in the form documented in RFC 2373 where the address is specified in hexadecimal using 16-bit values between colons. The prefix length is a decimal value that indicates how many of the high-order contiguous bits of the address comprise the prefix (the network portion of the address). For example, `2001:0DB8:8086:6502::/32` is a valid IPv6 prefix.

The IPv6 prefix identifies the type of IPv6 address. [Table D-3](#) shows the prefixes for each IPv6 address type.

**Table D-3** IPv6 Address Type Prefixes

| Address Type         | Binary Prefix                         | IPv6 Notation |
|----------------------|---------------------------------------|---------------|
| Unspecified          | 000...0 (128 bits)                    | ::/128        |
| Loopback             | 000...1 (128 bits)                    | ::1/128       |
| Multicast            | 11111111                              | FF00::/8      |
| Link-Local (unicast) | 1111111010                            | FE80::/10     |
| Site-Local (unicast) | 1111111111                            | FEC0::/10     |
| Global (unicast)     | All other addresses.                  |               |
| Anycast              | Taken from the unicast address space. |               |

# Protocols and Applications

Table D-4 lists the protocol literal values and port numbers; either can be entered in security appliance commands.

**Table D-4 Protocol Literal Values**

| Literal | Value | Description                                                                                                               |
|---------|-------|---------------------------------------------------------------------------------------------------------------------------|
| ah      | 51    | Authentication Header for IPv6, RFC 1826.                                                                                 |
| eigrp   | 88    | Enhanced Interior Gateway Routing Protocol.                                                                               |
| esp     | 50    | Encapsulated Security Payload for IPv6, RFC 1827.                                                                         |
| gre     | 47    | Generic Routing Encapsulation.                                                                                            |
| icmp    | 1     | Internet Control Message Protocol, RFC 792.                                                                               |
| icmp6   | 58    | Internet Control Message Protocol for IPv6, RFC 2463.                                                                     |
| igmp    | 2     | Internet Group Management Protocol, RFC 1112.                                                                             |
| igrp    | 9     | Interior Gateway Routing Protocol.                                                                                        |
| ip      | 0     | Internet Protocol.                                                                                                        |
| ipinip  | 4     | IP-in-IP encapsulation.                                                                                                   |
| ipsec   | 50    | IP Security. Entering the ipsec protocol literal is equivalent to entering the esp protocol literal.                      |
| nos     | 94    | Network Operating System (Novell's NetWare).                                                                              |
| ospf    | 89    | Open Shortest Path First routing protocol, RFC 1247.                                                                      |
| pcp     | 108   | Payload Compression Protocol.                                                                                             |
| pim     | 103   | Protocol Independent Multicast.                                                                                           |
| pptp    | 47    | Point-to-Point Tunneling Protocol. Entering the pptp protocol literal is equivalent to entering the gre protocol literal. |
| snp     | 109   | Sitara Networks Protocol.                                                                                                 |
| tcp     | 6     | Transmission Control Protocol, RFC 793.                                                                                   |
| udp     | 17    | User Datagram Protocol, RFC 768.                                                                                          |

Protocol numbers can be viewed online at the IANA website:

<http://www.iana.org/assignments/protocol-numbers>

# TCP and UDP Ports

Table D-5 lists the literal values and port numbers; either can be entered in security appliance commands. See the following caveats:

- The security appliance uses port 1521 for SQL\*Net. This is the default port used by Oracle for SQL\*Net. This value, however, does not agree with IANA port assignments.
- The security appliance listens for RADIUS on ports 1645 and 1646. If your RADIUS server uses the standard ports 1812 and 1813, you can configure the security appliance to listen to those ports using the **authentication-port** and **accounting-port** commands.
- To assign a port for DNS access, use the **domain** literal value, not **dns**. If you use **dns**, the security appliance assumes you meant to use the **dnsix** literal value.

Port numbers can be viewed online at the IANA website:

<http://www.iana.org/assignments/port-numbers>

**Table D-5** Port Literal Values

| Literal    | TCP or UDP? | Value | Description                                                                |
|------------|-------------|-------|----------------------------------------------------------------------------|
| aol        | TCP         | 5190  | America Online                                                             |
| bgp        | TCP         | 179   | Border Gateway Protocol, RFC 1163                                          |
| biff       | UDP         | 512   | Used by mail system to notify users that new mail is received              |
| bootpc     | UDP         | 68    | Bootstrap Protocol Client                                                  |
| bootps     | UDP         | 67    | Bootstrap Protocol Server                                                  |
| chargen    | TCP         | 19    | Character Generator                                                        |
| citrix-ica | TCP         | 1494  | Citrix Independent Computing Architecture (ICA) protocol                   |
| cmd        | TCP         | 514   | Similar to <b>exec</b> except that <b>cmd</b> has automatic authentication |
| ctiqbe     | TCP         | 2748  | Computer Telephony Interface Quick Buffer Encoding                         |
| daytime    | TCP         | 13    | Day time, RFC 867                                                          |
| discard    | TCP, UDP    | 9     | Discard                                                                    |
| domain     | TCP, UDP    | 53    | DNS                                                                        |
| dnsix      | UDP         | 195   | DNSIX Session Management Module Audit Redirector                           |
| echo       | TCP, UDP    | 7     | Echo                                                                       |
| exec       | TCP         | 512   | Remote process execution                                                   |
| finger     | TCP         | 79    | Finger                                                                     |
| ftp        | TCP         | 21    | File Transfer Protocol (control port)                                      |
| ftp-data   | TCP         | 20    | File Transfer Protocol (data port)                                         |
| gopher     | TCP         | 70    | Gopher                                                                     |
| https      | TCP         | 443   | HTTP over SSL                                                              |



**Table D-5 Port Literal Values (continued)**

| Literal           | TCP or UDP? | Value | Description                                                       |
|-------------------|-------------|-------|-------------------------------------------------------------------|
| h323              | TCP         | 1720  | H.323 call signalling                                             |
| hostname          | TCP         | 101   | NIC Host Name Server                                              |
| ident             | TCP         | 113   | Ident authentication service                                      |
| imap4             | TCP         | 143   | Internet Message Access Protocol, version 4                       |
| irc               | TCP         | 194   | Internet Relay Chat protocol                                      |
| isakmp            | UDP         | 500   | Internet Security Association and Key Management Protocol         |
| kerberos          | TCP, UDP    | 750   | Kerberos                                                          |
| klogin            | TCP         | 543   | KLOGIN                                                            |
| kshell            | TCP         | 544   | Korn Shell                                                        |
| ldap              | TCP         | 389   | Lightweight Directory Access Protocol                             |
| ldaps             | TCP         | 636   | Lightweight Directory Access Protocol (SSL)                       |
| lpd               | TCP         | 515   | Line Printer Daemon - printer spooler                             |
| login             | TCP         | 513   | Remote login                                                      |
| lotusnotes        | TCP         | 1352  | IBM Lotus Notes                                                   |
| mobile-ip         | UDP         | 434   | MobileIP-Agent                                                    |
| nameserver        | UDP         | 42    | Host Name Server                                                  |
| netbios-ns        | UDP         | 137   | NetBIOS Name Service                                              |
| netbios-dgm       | UDP         | 138   | NetBIOS Datagram Service                                          |
| netbios-ssn       | TCP         | 139   | NetBIOS Session Service                                           |
| nntp              | TCP         | 119   | Network News Transfer Protocol                                    |
| ntp               | UDP         | 123   | Network Time Protocol                                             |
| pcanywhere-status | UDP         | 5632  | pcAnywhere status                                                 |
| pcanywhere-data   | TCP         | 5631  | pcAnywhere data                                                   |
| pim-auto-rp       | TCP, UDP    | 496   | Protocol Independent Multicast, reverse path flooding, dense mode |
| pop2              | TCP         | 109   | Post Office Protocol - Version 2                                  |
| pop3              | TCP         | 110   | Post Office Protocol - Version 3                                  |
| pptp              | TCP         | 1723  | Point-to-Point Tunneling Protocol                                 |
| radius            | UDP         | 1645  | Remote Authentication Dial-In User Service                        |
| radius-acct       | UDP         | 1646  | Remote Authentication Dial-In User Service (accounting)           |
| rip               | UDP         | 520   | Routing Information Protocol                                      |
| secureid-udp      | UDP         | 5510  | SecureID over UDP                                                 |
| smtp              | TCP         | 25    | Simple Mail Transport Protocol                                    |
| snmp              | UDP         | 161   | Simple Network Management Protocol                                |
| snmptrap          | UDP         | 162   | Simple Network Management Protocol - Trap                         |

**Table D-5** Port Literal Values (continued)

| Literal      | TCP or UDP? | Value | Description                                           |
|--------------|-------------|-------|-------------------------------------------------------|
| sqlnet       | TCP         | 1521  | Structured Query Language Network                     |
| ssh          | TCP         | 22    | Secure Shell                                          |
| sunrpc (rpc) | TCP, UDP    | 111   | Sun Remote Procedure Call                             |
| syslog       | UDP         | 514   | System Log                                            |
| tacacs       | TCP, UDP    | 49    | Terminal Access Controller Access Control System Plus |
| talk         | TCP, UDP    | 517   | Talk                                                  |
| telnet       | TCP         | 23    | RFC 854 Telnet                                        |
| tftp         | UDP         | 69    | Trivial File Transfer Protocol                        |
| time         | UDP         | 37    | Time                                                  |
| uucp         | TCP         | 540   | UNIX-to-UNIX Copy Program                             |
| who          | UDP         | 513   | Who                                                   |
| whois        | TCP         | 43    | Who Is                                                |
| www          | TCP         | 80    | World Wide Web                                        |
| xdmcp        | UDP         | 177   | X Display Manager Control Protocol                    |

## Local Ports and Protocols

Table D-6 lists the protocols, TCP ports, and UDP ports that the security appliance may open to process traffic destined to the security appliance. Unless you enable the features and services listed in Table D-6, the security appliance does *not* open any local protocols or any TCP or UDP ports. You must configure a feature or service for the security appliance to open the default listening protocol or port. In many cases you can configure ports other than the default port when you enable a feature or service.

**Table D-6** Protocols and Ports Opened by Features and Services

| Feature or Service     | Protocol | Port Number | Comments                                               |
|------------------------|----------|-------------|--------------------------------------------------------|
| DHCP                   | UDP      | 67,68       | —                                                      |
| Failover Control       | 108      | N/A         | —                                                      |
| HTTP                   | TCP      | 80          | —                                                      |
| HTTPS                  | TCP      | 443         | —                                                      |
| ICMP                   | 1        | N/A         | —                                                      |
| IGMP                   | 2        | N/A         | Protocol only open on destination IP address 224.0.0.1 |
| ISAKMP/IKE             | UDP      | 500         | Configurable.                                          |
| IPSec (ESP)            | 50       | N/A         | —                                                      |
| IPSec over UDP (NAT-T) | UDP      | 4500        | —                                                      |

**Table D-6** *Protocols and Ports Opened by Features and Services (continued)*

| Feature or Service                                      | Protocol | Port Number | Comments                                                                                   |
|---------------------------------------------------------|----------|-------------|--------------------------------------------------------------------------------------------|
| IPSec over UDP<br>(Cisco VPN 3000<br>Series compatible) | UDP      | 10000       | Configurable.                                                                              |
| IPSec over TCP<br>(CTCP)                                | TCP      | —           | No default port is used. You must specify the port number when configuring IPSec over TCP. |
| NTP                                                     | UDP      | 123         | —                                                                                          |
| OSPF                                                    | 89       | N/A         | Protocol only open on destination IP address 224.0.0.5 and 224.0.0.6                       |
| PIM                                                     | 103      | N/A         | Protocol only open on destination IP address 224.0.0.13                                    |
| RIP                                                     | UDP      | 520         | —                                                                                          |
| RIPv2                                                   | UDP      | 520         | Port only open on destination IP address 224.0.0.9                                         |
| SNMP                                                    | UDP      | 161         | Configurable.                                                                              |
| SSH                                                     | TCP      | 22          | —                                                                                          |
| Stateful Update                                         | 105      | N/A         | —                                                                                          |
| Telnet                                                  | TCP      | 23          | —                                                                                          |
| VPN Load Balancing                                      | UDP      | 9023        | Configurable.                                                                              |
| VPN Individual User<br>Authentication Proxy             | UDP      | 1645, 1646  | Port accessible only over VPN tunnel.                                                      |

## ICMP Types

Table D-7 lists the ICMP type numbers and names that you can enter in security appliance commands:

**Table D-7** *ICMP Types*

| ICMP Number | ICMP Name            |
|-------------|----------------------|
| 0           | echo-reply           |
| 3           | unreachable          |
| 4           | source-quench        |
| 5           | redirect             |
| 6           | alternate-address    |
| 8           | echo                 |
| 9           | router-advertisement |
| 10          | router-solicitation  |
| 11          | time-exceeded        |
| 12          | parameter-problem    |

**Table D-7** ICMP Types (continued)

| ICMP Number | ICMP Name           |
|-------------|---------------------|
| 13          | timestamp-request   |
| 14          | timestamp-reply     |
| 15          | information-request |
| 16          | information-reply   |
| 17          | mask-request        |
| 18          | mask-reply          |
| 31          | conversion-error    |
| 32          | mobile-redirect     |



---

## Numerics

**3DES** See [DES](#).

---

## A

**AAA** Authentication, authorization, and accounting. See also [TACACS+](#) and [RADIUS](#).

**ABR** Area Border Router. In [OSPF](#), a router with interfaces in multiple areas.

**ACE** Access Control Entry. Information entered into the configuration that lets you specify what type of traffic to permit or deny on an [interface](#). By default, traffic that is not explicitly permitted is denied.

**Access Modes** The security appliance CLI uses several command modes. The commands available in each mode vary. See also [user EXEC mode](#), [privileged EXEC mode](#), [global configuration mode](#), [command-specific configuration mode](#).

**ACL** Access Control List. A collection of [ACEs](#). An ACL lets you specify what type of traffic to allow on an interface. By default, traffic that is not explicitly permitted is denied. ACLs are usually applied to the [interface](#) which is the source of inbound traffic. See also [rule](#), [outbound ACL](#).

**ActiveX** A set of object-oriented programming technologies and tools used to create mobile or portable programs. An ActiveX program is roughly equivalent to a Java applet.

**Address Resolution Protocol** See [ARP](#).

**address translation** The translation of a network address and/or port to another network address/or port. See also [IP address](#), [interface PAT](#), [NAT](#), [PAT](#), [Static PAT](#), [xlate](#).

**AES** Advanced Encryption Standard. A symmetric block cipher that can encrypt and decrypt information. The AES algorithm is capable of using cryptographic keys of 128, 192 and 256 bits to encrypt and decrypt data in blocks of 128 bits. See also [DES](#).

**AH** Authentication Header. An IP protocol (type 51) that can ensure data integrity, authentication, and replay detection. AH is embedded in the data to be protected (a full IP datagram, for example). AH can be used either by itself or with [ESP](#). This is an older [IPSec](#) protocol that is less important in most networks than [ESP](#). AH provides authentication services but does not provide encryption services. It is provided to ensure compatibility with [IPSec](#) peers that do not support [ESP](#), which provides both [authentication](#) and [encryption](#). See also [encryption](#) and [VPN](#). Refer to the RFC 2402.

**A record address** “A” stands for address, and refers to name-to-address mapped records in [DNS](#).

|                              |                                                                                                                                                                                                                                                                                                                                                                                                                                    |
|------------------------------|------------------------------------------------------------------------------------------------------------------------------------------------------------------------------------------------------------------------------------------------------------------------------------------------------------------------------------------------------------------------------------------------------------------------------------|
| <b>ARP</b>                   | Address Resolution Protocol. A low-level TCP/IP protocol that maps a hardware address, or MAC address, to an IP address. An example hardware address is 00:00:a6:00:01:ba. The first three groups of characters (00:00:a6) identify the manufacturer; the rest of the characters (00:01:ba) identify the system card. ARP is defined in RFC 826.                                                                                   |
| <b>ASA</b>                   | Adaptive Security Algorithm. Used by the security appliance to perform inspections. ASA allows one-way (inside to outside) connections without an explicit configuration for each internal system and application. See also <a href="#">inspection engine</a> .                                                                                                                                                                    |
| <b>ASA</b>                   | adaptive security appliance.                                                                                                                                                                                                                                                                                                                                                                                                       |
| <b>ASDM</b>                  | Adaptive Security Device Manager. An application for managing and configuring a single security appliance.                                                                                                                                                                                                                                                                                                                         |
| <b>asymmetric encryption</b> | Also called public key systems, asymmetric encryption allows anyone to obtain access to the public key of anyone else. Once the public key is accessed, one can send an encrypted message to that person using the public key. See also <a href="#">encryption</a> , <a href="#">public key</a> .                                                                                                                                  |
| <b>authentication</b>        | Cryptographic protocols and services that verify the identity of users and the integrity of data. One of the functions of the <a href="#">IPSec</a> framework. Authentication establishes the integrity of datastream and ensures that it is not tampered with in transit. It also provides confirmation about the origin of the datastream. See also <a href="#">AAA</a> , <a href="#">encryption</a> , and <a href="#">VPN</a> . |

---

## B

|                   |                                                                                                                                                                                                                                                                                                                                                         |
|-------------------|---------------------------------------------------------------------------------------------------------------------------------------------------------------------------------------------------------------------------------------------------------------------------------------------------------------------------------------------------------|
| <b>BGP</b>        | Border Gateway Protocol. BGP performs interdomain routing in TCP/IP networks. BGP is an Exterior Gateway Protocol, which means that it performs routing between multiple autonomous systems or domains and exchanges routing and access information with other BGP systems. The security appliance does not support BGP. See also <a href="#">EGP</a> . |
| <b>BLT stream</b> | Bandwidth Limited Traffic stream. Stream or flow of packets whose bandwidth is constrained.                                                                                                                                                                                                                                                             |
| <b>BOOTP</b>      | Bootstrap Protocol. Lets diskless workstations boot over the network as is described in RFC 951 and RFC 1542.                                                                                                                                                                                                                                           |
| <b>BPDU</b>       | Bridge Protocol Data Unit. Spanning-Tree Protocol hello packet that is sent out at configurable intervals to exchange information among bridges in the network. Protocol data unit is the OSI term for packet.                                                                                                                                          |

---

## C

|              |                                                                                                                                                                                                                                                                                                                                                                                                                            |
|--------------|----------------------------------------------------------------------------------------------------------------------------------------------------------------------------------------------------------------------------------------------------------------------------------------------------------------------------------------------------------------------------------------------------------------------------|
| <b>CA</b>    | Certificate Authority, Certification Authority. A third-party entity that is responsible for issuing and revoking certificates. Each device with the public key of the CA can authenticate a device that has a certificate issued by the CA. The term CA also refers to software that provides CA services. See also <a href="#">certificate</a> , <a href="#">CRL</a> , <a href="#">public key</a> , <a href="#">RA</a> . |
| <b>cache</b> | A temporary repository of information accumulated from previous task executions that can be reused, decreasing the time required to perform the tasks.                                                                                                                                                                                                                                                                     |

|                                            |                                                                                                                                                                                                                                                                                                                                                                                                                                                                                                                                                                                                                                                                                                                                                                                                                                                                                 |
|--------------------------------------------|---------------------------------------------------------------------------------------------------------------------------------------------------------------------------------------------------------------------------------------------------------------------------------------------------------------------------------------------------------------------------------------------------------------------------------------------------------------------------------------------------------------------------------------------------------------------------------------------------------------------------------------------------------------------------------------------------------------------------------------------------------------------------------------------------------------------------------------------------------------------------------|
| <b>CBC</b>                                 | Cipher Block Chaining. A cryptographic technique that increases the encryption strength of an algorithm. CBC requires an initialization vector (IV) to start encryption. The IV is explicitly given in the <a href="#">IPSec</a> packet.                                                                                                                                                                                                                                                                                                                                                                                                                                                                                                                                                                                                                                        |
| <b>certificate</b>                         | A signed cryptographic object that contains the identity of a user or device and the public key of the <a href="#">CA</a> that issued the certificate. Certificates have an expiration date and may also be placed on a <a href="#">CRL</a> if known to be compromised. Certificates also establish non-repudiation for <a href="#">IKE</a> negotiation, which means that you can prove to a third party that <a href="#">IKE</a> negotiation was completed with a specific peer.                                                                                                                                                                                                                                                                                                                                                                                               |
| <b>CHAP</b>                                | Challenge Handshake Authentication Protocol.                                                                                                                                                                                                                                                                                                                                                                                                                                                                                                                                                                                                                                                                                                                                                                                                                                    |
| <b>CLI</b>                                 | command line interface. The primary interface for entering configuration and monitoring commands to the security appliance.                                                                                                                                                                                                                                                                                                                                                                                                                                                                                                                                                                                                                                                                                                                                                     |
| <b>client/server computing</b>             | Distributed computing (processing) network systems in which transaction responsibilities are divided into two parts: client (front end) and server (back end). Also called distributed computing. See also <a href="#">RPC</a> .                                                                                                                                                                                                                                                                                                                                                                                                                                                                                                                                                                                                                                                |
| <b>command-specific configuration mode</b> | From global configuration mode, some commands enter a command-specific configuration mode. All user EXEC, privileged EXEC, global configuration, and command-specific configuration commands are available in this mode. See also <a href="#">global configuration mode</a> , <a href="#">privileged EXEC mode</a> , <a href="#">user EXEC mode</a> .                                                                                                                                                                                                                                                                                                                                                                                                                                                                                                                           |
| <b>configuration, config, config file</b>  | A file on the security appliance that represents the equivalent of settings, preferences, and properties administered by <a href="#">ASDM</a> or the <a href="#">CLI</a> .                                                                                                                                                                                                                                                                                                                                                                                                                                                                                                                                                                                                                                                                                                      |
| <b>cookie</b>                              | A cookie is a object stored by a browser. Cookies contain information, such as user preferences, to persistent storage.                                                                                                                                                                                                                                                                                                                                                                                                                                                                                                                                                                                                                                                                                                                                                         |
| <b>CPU</b>                                 | Central Processing Unit. Main processor.                                                                                                                                                                                                                                                                                                                                                                                                                                                                                                                                                                                                                                                                                                                                                                                                                                        |
| <b>CRC</b>                                 | Cyclical Redundancy Check. Error-checking technique in which the frame recipient calculates a remainder by dividing frame contents by a prime binary divisor and compares the calculated remainder to a value stored in the frame by the sending node.                                                                                                                                                                                                                                                                                                                                                                                                                                                                                                                                                                                                                          |
| <b>CRL</b>                                 | Certificate Revocation List. A digitally signed message that lists all of the current but revoked certificates listed by a given <a href="#">CA</a> . This is analogous to a book of stolen charge card numbers that allow stores to reject bad credit cards. When certificates are revoked, they are added to a CRL. When you implement authentication using certificates, you can choose to use CRLs or not. Using CRLs lets you easily revoke certificates before they expire, but the CRL is generally only maintained by the <a href="#">CA</a> or an <a href="#">RA</a> . If you are using CRLs and the connection to the <a href="#">CA</a> or <a href="#">RA</a> is not available when authentication is requested, the authentication request will fail. See also <a href="#">CA</a> , <a href="#">certificate</a> , <a href="#">public key</a> , <a href="#">RA</a> . |
| <b>CRV</b>                                 | Call Reference Value. Used by <a href="#">H.225.0</a> to distinguish call legs signalled between two entities.                                                                                                                                                                                                                                                                                                                                                                                                                                                                                                                                                                                                                                                                                                                                                                  |
| <b>cryptography</b>                        | Encryption, authentication, integrity, keys and other services used for secure communication over networks. See also <a href="#">VPN</a> and <a href="#">IPSec</a> .                                                                                                                                                                                                                                                                                                                                                                                                                                                                                                                                                                                                                                                                                                            |
| <b>crypto map</b>                          | A data structure with a unique name and sequence number that is used for configuring VPNs on the security appliance. A crypto map selects data flows that need security processing and defines the policy for these flows and the crypto peer that traffic needs to go to. A crypto map is applied to an interface. Crypto maps contain the <a href="#">ACLs</a> , encryption standards, peers, and other parameters necessary to specify security policies for <a href="#">VPNs</a> using <a href="#">IKE</a> and <a href="#">IPSec</a> . See also <a href="#">VPN</a> .                                                                                                                                                                                                                                                                                                       |

**CTIQBE** Computer Telephony Interface Quick Buffer Encoding. A protocol used in IP telephony between the Cisco CallManager and CTI [TAPI](#) and [JTAPI](#) applications. CTIQBE is used by the TAPI/JTAPI protocol inspection module and supports [NAT](#), [PAT](#), and bi-directional [NAT](#). This enables Cisco IP SoftPhone and other Cisco TAPI/JTAPI applications to communicate with Cisco CallManager for call setup and voice traffic across the security appliance.

**cut-through proxy** Enables the security appliance to provide faster traffic flow after user authentication. The cut-through proxy challenges a user initially at the application layer. After the security appliance authenticates the user, it shifts the session flow and all traffic flows directly and quickly between the source and destination while maintaining session state information.

---

## D

**data confidentiality** Describes any method that manipulates data so that no attacker can read it. This is commonly achieved by data encryption and [keys](#) that are only available to the parties involved in the communication.

**data integrity** Describes mechanisms that, through the use of encryption based on [secret key](#) or [public key](#) algorithms, allow the recipient of a piece of protected data to verify that the data has not been modified in transit.

**data origin authentication** A security service where the receiver can verify that protected data could have originated only from the sender. This service requires a data integrity service plus a [key](#) distribution mechanism, where a [secret key](#) is shared only between the sender and receiver.

**decryption** Application of a specific algorithm or cipher to encrypted data so as to render the data comprehensible to those who are authorized to see the information. See also [encryption](#).

**DES** Data encryption standard. DES was published in 1977 by the National Bureau of Standards and is a secret key encryption scheme based on the Lucifer algorithm from IBM. Cisco uses DES in classic crypto (40-bit and 56-bit key lengths), [IPSec](#) crypto (56-bit key), and 3DES (triple DES), which performs encryption three times using a 56-bit key. 3DES is more secure than DES but requires more processing for encryption and decryption. See also [AES](#), [ESP](#).

**DHCP** Dynamic Host Configuration Protocol. Provides a mechanism for allocating IP addresses to hosts dynamically, so that addresses can be reused when hosts no longer need them and so that mobile computers, such as laptops, receive an IP address applicable to the [LAN](#) to which it is connected.

**Diffie-Hellman** A public key cryptography protocol that allows two parties to establish a shared secret over insecure communications channels. Diffie-Hellman is used within [IKE](#) to establish session keys. Diffie-Hellman is a component of [Oakley](#) key exchange.

**Diffie-Hellman Group 1, Group 2, Group 5, Group 7** Diffie-Hellman refers to a type of public key cryptography using asymmetric encryption based on large prime numbers to establish both Phase 1 and Phase 2 [SAs](#). Group 1 provides a smaller prime number than Group 2 but may be the only version supported by some [IPSec](#) peers. Diffie-Hellman Group 5 uses a 1536-bit prime number, is the most secure, and is recommended for use with [AES](#). Group 7 has an elliptical curve field size of 163 bits and is for use with the Movian VPN client, but works with any peer that supports Group 7 (ECC). See also [VPN](#) and [encryption](#).

**digital certificate** See [certificate](#).

**DMZ** See [interface](#).



|                    |                                                                                                                                                                                                                                                                                                                                                                                                                                                                                                                                                                                           |
|--------------------|-------------------------------------------------------------------------------------------------------------------------------------------------------------------------------------------------------------------------------------------------------------------------------------------------------------------------------------------------------------------------------------------------------------------------------------------------------------------------------------------------------------------------------------------------------------------------------------------|
| <b>DN</b>          | Distinguished Name. Global, authoritative name of an entry in the OSI Directory (X.500).                                                                                                                                                                                                                                                                                                                                                                                                                                                                                                  |
| <b>DNS</b>         | Domain Name System (or Service). An Internet service that translates domain names into IP addresses.                                                                                                                                                                                                                                                                                                                                                                                                                                                                                      |
| <b>DoS</b>         | Denial of Service. A type of network attack in which the goal is to render a network service unavailable.                                                                                                                                                                                                                                                                                                                                                                                                                                                                                 |
| <b>DSL</b>         | digital subscriber line. Public network technology that delivers high bandwidth over conventional copper wiring at limited distances. DSL is provisioned via modem pairs, with one modem located at a central office and the other at the customer site. Because most DSL technologies do not use the whole bandwidth of the twisted pair, there is room remaining for a voice channel.                                                                                                                                                                                                   |
| <b>DSP</b>         | digital signal processor. A DSP segments a voice signal into frames and stores them in voice packets.                                                                                                                                                                                                                                                                                                                                                                                                                                                                                     |
| <b>DSS</b>         | Digital Signature Standard. A digital signature algorithm designed by The US National Institute of Standards and Technology and based on public-key cryptography. DSS does not do user datagram encryption. DSS is a component in classic crypto, as well as the Redcreek <a href="#">IPSec</a> card, but not in <a href="#">IPSec</a> implemented in Cisco IOS software.                                                                                                                                                                                                                 |
| <b>Dynamic NAT</b> | See <a href="#">NAT</a> and <a href="#">address translation</a> .                                                                                                                                                                                                                                                                                                                                                                                                                                                                                                                         |
| <b>Dynamic PAT</b> | Dynamic Port Address Translation. Dynamic PAT lets multiple outbound sessions appear to originate from a single IP address. With PAT enabled, the security appliance chooses a unique port number from the PAT IP address for each outbound translation slot ( <a href="#">xlate</a> ). This feature is valuable when an <a href="#">ISP</a> cannot allocate enough unique IP addresses for your outbound connections. The global pool addresses always come first, before a PAT address is used. See also <a href="#">NAT</a> , <a href="#">Static PAT</a> , and <a href="#">xlate</a> . |
| <hr/>              |                                                                                                                                                                                                                                                                                                                                                                                                                                                                                                                                                                                           |
| <b>E</b>           |                                                                                                                                                                                                                                                                                                                                                                                                                                                                                                                                                                                           |
| <b>ECHO</b>        | See <a href="#">Ping</a> , <a href="#">ICMP</a> . See also <a href="#">inspection engine</a> .                                                                                                                                                                                                                                                                                                                                                                                                                                                                                            |
| <b>EGP</b>         | Exterior Gateway Protocol. Replaced by BGP. The security appliance does not support EGP. See also <a href="#">BGP</a> .                                                                                                                                                                                                                                                                                                                                                                                                                                                                   |
| <b>EIGRP</b>       | Enhanced Interior Gateway Routing Protocol. The security appliance does not support EIGRP.                                                                                                                                                                                                                                                                                                                                                                                                                                                                                                |
| <b>EMBLEM</b>      | Enterprise Management BaseLine Embedded Manageability. A syslog format designed to be consistent with the Cisco IOS system log format and is more compatible with CiscoWorks management applications.                                                                                                                                                                                                                                                                                                                                                                                     |
| <b>encryption</b>  | Application of a specific algorithm or cipher to data so as to render the data incomprehensible to those unauthorized to see the information. See also <a href="#">decryption</a> .                                                                                                                                                                                                                                                                                                                                                                                                       |
| <b>ESMTP</b>       | Extended <a href="#">SMTP</a> . Extended version of <a href="#">SMTP</a> that includes additional functionality, such as delivery notification and session delivery. ESMTP is described in RFC 1869, SMTP Service Extensions.                                                                                                                                                                                                                                                                                                                                                             |
| <b>ESP</b>         | Encapsulating Security Payload. An <a href="#">IPSec</a> protocol, ESP provides authentication and encryption services for establishing a secure tunnel over an insecure network. For more information, refer to RFCs 2406 and 1827.                                                                                                                                                                                                                                                                                                                                                      |

---

**F**

|                                |                                                                                                                                                                                                                                                                                                                                                                                                                                                                                                                                                                                                                                                                                                                                                    |
|--------------------------------|----------------------------------------------------------------------------------------------------------------------------------------------------------------------------------------------------------------------------------------------------------------------------------------------------------------------------------------------------------------------------------------------------------------------------------------------------------------------------------------------------------------------------------------------------------------------------------------------------------------------------------------------------------------------------------------------------------------------------------------------------|
| <b>failover, failover mode</b> | Failover lets you configure two security appliances so that one will take over operation if the other one fails. The security appliance supports two failover configurations, Active/Active failover and Active/Standby failover. Each failover configuration has its own method for determining and performing failover. With Active/Active failover, both units can pass network traffic. This lets you configure load balancing on your network. Active/Active failover is only available on units running in multiple context mode. With Active/Standby failover, only one unit passes traffic while the other unit waits in a standby state. Active/Standby failover is available on units running in either single or multiple context mode. |
| <b>Fixup</b>                   | See <a href="#">inspection engine</a> .                                                                                                                                                                                                                                                                                                                                                                                                                                                                                                                                                                                                                                                                                                            |
| <b>Flash, Flash memory</b>     | A nonvolatile storage device used to store the configuration file when the security appliance is powered down.                                                                                                                                                                                                                                                                                                                                                                                                                                                                                                                                                                                                                                     |
| <b>FQDN/IP</b>                 | Fully qualified domain name/IP address. <a href="#">IPSec</a> parameter that identifies peers that are security gateways.                                                                                                                                                                                                                                                                                                                                                                                                                                                                                                                                                                                                                          |
| <b>FragGuard</b>               | Provides IP fragment protection and performs full reassembly of all <a href="#">ICMP</a> error messages and virtual reassembly of the remaining IP fragments that are routed through the security appliance.                                                                                                                                                                                                                                                                                                                                                                                                                                                                                                                                       |
| <b>FTP</b>                     | File Transfer Protocol. Part of the TCP/IP protocol stack, used for transferring files between hosts.                                                                                                                                                                                                                                                                                                                                                                                                                                                                                                                                                                                                                                              |

---

**G**

|                                  |                                                                                                                                                                                                                                                                                                                                                                                                                                                     |
|----------------------------------|-----------------------------------------------------------------------------------------------------------------------------------------------------------------------------------------------------------------------------------------------------------------------------------------------------------------------------------------------------------------------------------------------------------------------------------------------------|
| <b>GGSN</b>                      | gateway <a href="#">GPRS</a> support node. A wireless gateway that allows mobile cell phone users to access the public data network or specified private IP networks.                                                                                                                                                                                                                                                                               |
| <b>global configuration mode</b> | Global configuration mode lets you to change the security appliance configuration. All user EXEC, privileged EXEC, and global configuration commands are available in this mode. See also <a href="#">user EXEC mode</a> , <a href="#">privileged EXEC mode</a> , <a href="#">command-specific configuration mode</a> .                                                                                                                             |
| <b>GMT</b>                       | Greenwich Mean Time. Replaced by UTC (Coordinated Universal Time) in 1967 as the world time standard.                                                                                                                                                                                                                                                                                                                                               |
| <b>GPRS</b>                      | general packet radio service. A service defined and standardized by the European Telecommunication Standards Institute. GPRS is an IP-packet-based extension of <a href="#">GSM</a> networks and provides mobile, wireless, data communications                                                                                                                                                                                                     |
| <b>GRE</b>                       | Generic Routing Encapsulation described in RFCs 1701 and 1702. GRE is a tunneling protocol that can encapsulate a wide variety of protocol packet types inside IP tunnels, creating a virtual point-to-point link to routers at remote points over an IP network. By connecting multiprotocol subnetworks in a single-protocol backbone environment, IP tunneling using GRE allows network expansion across a single protocol backbone environment. |

|                             |                                                                                                                                                                                                                                                                                                                                                                                                                                                                                                                        |
|-----------------------------|------------------------------------------------------------------------------------------------------------------------------------------------------------------------------------------------------------------------------------------------------------------------------------------------------------------------------------------------------------------------------------------------------------------------------------------------------------------------------------------------------------------------|
| <b>GSM</b>                  | Global System for Mobile Communication. A digital, mobile, radio standard developed for mobile, wireless, voice communications.                                                                                                                                                                                                                                                                                                                                                                                        |
| <b>GTP</b>                  | GPRS tunneling protocol. GTP handles the flow of user packet data and signaling information between the <a href="#">SGSN</a> and <a href="#">GGSN</a> in a <a href="#">GPRS</a> network. GTP is defined on both the Gn and Gp interfaces of a <a href="#">GPRS</a> network.                                                                                                                                                                                                                                            |
| <hr/>                       |                                                                                                                                                                                                                                                                                                                                                                                                                                                                                                                        |
| <b>H</b>                    |                                                                                                                                                                                                                                                                                                                                                                                                                                                                                                                        |
| <b>H.225</b>                | A protocol used for TCP signalling in applications such as video conferencing. See also <a href="#">H.323</a> and <a href="#">inspection engine</a> .                                                                                                                                                                                                                                                                                                                                                                  |
| <b>H.225.0</b>              | An ITU standard that governs H.225.0 session establishment and packetization. H.225.0 actually describes several different protocols: RAS, use of Q.931, and use of <a href="#">RTP</a> .                                                                                                                                                                                                                                                                                                                              |
| <b>H.245</b>                | An ITU standard that governs H.245 endpoint control.                                                                                                                                                                                                                                                                                                                                                                                                                                                                   |
| <b>H.320</b>                | Suite of ITU-T standard specifications for video conferencing over circuit-switched media, such as ISDN, fractional T-1, and switched-56 lines. Extensions of ITU-T standard H.320 enable video conferencing over LANs and other packet-switched networks, as well as video over the <a href="#">Internet</a> .                                                                                                                                                                                                        |
| <b>H.323</b>                | Allows dissimilar communication devices to communicate with each other by using a standardized communication protocol. H.323 defines a common set of CODECs, call setup and negotiating procedures, and basic data transport methods.                                                                                                                                                                                                                                                                                  |
| <b>H.323 RAS</b>            | Registration, admission, and status signaling protocol. Enables devices to perform registration, admissions, bandwidth changes, and status and disengage procedures between <a href="#">VoIP</a> gateway and the gatekeeper.                                                                                                                                                                                                                                                                                           |
| <b>H.450.2</b>              | Call transfer supplementary service for <a href="#">H.323</a> .                                                                                                                                                                                                                                                                                                                                                                                                                                                        |
| <b>H.450.3</b>              | Call diversion supplementary service for <a href="#">H.323</a> .                                                                                                                                                                                                                                                                                                                                                                                                                                                       |
| <b>Hash, Hash Algorithm</b> | A hash algorithm is a one way function that operates on a message of arbitrary length to create a fixed-length message digest used by cryptographic services to ensure its data integrity. MD5 has a smaller digest and is considered to be slightly faster than <a href="#">SHA-1</a> . Cisco uses both <a href="#">SHA-1</a> and <a href="#">MD5</a> hashes within our implementation of the <a href="#">IPSec</a> framework. See also <a href="#">encryption</a> , <a href="#">HMAC</a> , and <a href="#">VPN</a> . |
| <b>headend</b>              | A firewall, concentrator, or other host that serves as the entry point into a private network for <a href="#">VPN</a> client connections over the public network. See also <a href="#">ISP</a> and <a href="#">VPN</a> .                                                                                                                                                                                                                                                                                               |
| <b>HMAC</b>                 | A mechanism for message authentication using cryptographic hashes such as <a href="#">SHA-1</a> and <a href="#">MD5</a> .                                                                                                                                                                                                                                                                                                                                                                                              |
| <b>host</b>                 | The name for any device on a TCP/IP network that has an IP address. See also <a href="#">network</a> and <a href="#">node</a> .                                                                                                                                                                                                                                                                                                                                                                                        |
| <b>host/network</b>         | An IP address and netmask used with other information to identify a single host or network subnet for security appliance configuration, such as an address translation ( <a href="#">xlate</a> ) or <a href="#">ACE</a> .                                                                                                                                                                                                                                                                                              |
| <b>HTTP</b>                 | Hypertext Transfer Protocol. A protocol used by browsers and web servers to transfer files. When a user views a web page, the browser can use HTTP to request and receive the files used by the web page. HTTP transmissions are not encrypted.                                                                                                                                                                                                                                                                        |
| <b>HTTPS</b>                | Hypertext Transfer Protocol Secure. An <a href="#">SSL</a> -encrypted version of HTTP.                                                                                                                                                                                                                                                                                                                                                                                                                                 |

## I

|                                    |                                                                                                                                                                                                                                                                                                                                                                                                                                                                                                                                                                                                                                                  |
|------------------------------------|--------------------------------------------------------------------------------------------------------------------------------------------------------------------------------------------------------------------------------------------------------------------------------------------------------------------------------------------------------------------------------------------------------------------------------------------------------------------------------------------------------------------------------------------------------------------------------------------------------------------------------------------------|
| <b>IANA</b>                        | Internet Assigned Number Authority. Assigns all port and protocol numbers for use on the <a href="#">Internet</a> .                                                                                                                                                                                                                                                                                                                                                                                                                                                                                                                              |
| <b>ICMP</b>                        | Internet Control Message Protocol. Network-layer Internet protocol that reports errors and provides other information relevant to IP packet processing.                                                                                                                                                                                                                                                                                                                                                                                                                                                                                          |
| <b>IDS</b>                         | Intrusion Detection System. A method of detecting malicious network activity by signatures and then implementing a policy for that signature.                                                                                                                                                                                                                                                                                                                                                                                                                                                                                                    |
| <b>IETF</b>                        | The Internet Engineering Task Force. A technical standards organization that develops <a href="#">RFC</a> documents defining protocols for the <a href="#">Internet</a> .                                                                                                                                                                                                                                                                                                                                                                                                                                                                        |
| <b>IGMP</b>                        | Internet Group Management Protocol. IGMP is a protocol used by IPv4 systems to report IP <a href="#">multicast</a> memberships to neighboring multicast routers.                                                                                                                                                                                                                                                                                                                                                                                                                                                                                 |
| <b>IKE</b>                         | Internet Key Exchange. IKE establishes a shared security policy and authenticates keys for services (such as <a href="#">IPSec</a> ) that require keys. Before any <a href="#">IPSec</a> traffic can be passed, each security appliance must verify the identity of its peer. This can be done by manually entering preshared keys into both hosts or by a <a href="#">CA</a> service. IKE is a hybrid protocol that uses part <a href="#">Oakley</a> and part of another protocol suite called <a href="#">SKEME</a> inside <a href="#">ISAKMP</a> framework. This is the protocol formerly known as ISAKMP/Oakley, and is defined in RFC 2409. |
| <b>IKE Extended Authentication</b> | IKE Extended Authenticate (Xauth) is implemented per the IETF draft-ietf-ipsec-isakmp-xauth-04.txt (“extended authentication” draft). This protocol provides the capability of authenticating a user within IKE using <a href="#">TACACS+</a> or <a href="#">RADIUS</a> .                                                                                                                                                                                                                                                                                                                                                                        |
| <b>IKE Mode Configuration</b>      | IKE Mode Configuration is implemented per the IETF draft-ietf-ipsec-isakmp-mode-cfg-04.txt. IKE Mode Configuration provides a method for a security gateway to download an IP address (and other network level configuration) to the VPN client as part of an IKE negotiation.                                                                                                                                                                                                                                                                                                                                                                   |
| <b>ILS</b>                         | Internet Locator Service. ILS is based on LDAP and is ILSv2 compliant. ILS was developed by Microsoft for use with its NetMeeting, SiteServer, and Active Directory products.                                                                                                                                                                                                                                                                                                                                                                                                                                                                    |
| <b>IMAP</b>                        | Internet Message Access Protocol. Method of accessing e-mail or bulletin board messages kept on a mail server that can be shared. IMAP permits client e-mail applications to access remote message stores as if they were local without actually transferring the message.                                                                                                                                                                                                                                                                                                                                                                       |
| <b>implicit rule</b>               | An access rule automatically created by the security appliance based on default rules or as a result of user-defined rules.                                                                                                                                                                                                                                                                                                                                                                                                                                                                                                                      |
| <b>IMSI</b>                        | International Mobile Subscriber Identity. One of two components of a <a href="#">GTP</a> tunnel ID, the other being the <a href="#">NSAPI</a> . See also <a href="#">NSAPI</a> .                                                                                                                                                                                                                                                                                                                                                                                                                                                                 |
| <b>inside</b>                      | The first interface, usually port 1, that connects your internal, “trusted” network protected by the security appliance. See also <a href="#">interface</a> , <a href="#">interface names</a> .                                                                                                                                                                                                                                                                                                                                                                                                                                                  |

|                             |                                                                                                                                                                                                                                                                                                                                                                                                                                                                                                                                                                                                                                                                                                                                                                                                                                                                                                                                                                                                                                             |
|-----------------------------|---------------------------------------------------------------------------------------------------------------------------------------------------------------------------------------------------------------------------------------------------------------------------------------------------------------------------------------------------------------------------------------------------------------------------------------------------------------------------------------------------------------------------------------------------------------------------------------------------------------------------------------------------------------------------------------------------------------------------------------------------------------------------------------------------------------------------------------------------------------------------------------------------------------------------------------------------------------------------------------------------------------------------------------------|
| <b>inspection engine</b>    | The security appliance inspects certain application-level protocols to identify the location of embedded addressing information in traffic. This allows <a href="#">NAT</a> to translate these embedded addresses and to update any checksum or other fields that are affected by the translation. Because many protocols open secondary <a href="#">TCP</a> or <a href="#">UDP</a> ports, each application inspection engine also monitors sessions to determine the port numbers for secondary channels. The initial session on a well-known port is used to negotiate dynamically assigned port numbers. The application inspection engine monitors these sessions, identifies the dynamic port assignments, and permits data exchange on these ports for the duration of the specific session. Some of the protocols that the security appliance can inspect are <a href="#">CTIQBE</a> , <a href="#">FTP</a> , <a href="#">H.323</a> , <a href="#">HTTP</a> , <a href="#">MGCP</a> , <a href="#">SMTP</a> , and <a href="#">SNMP</a> . |
| <b>interface</b>            | The physical connection between a particular network and a security appliance.                                                                                                                                                                                                                                                                                                                                                                                                                                                                                                                                                                                                                                                                                                                                                                                                                                                                                                                                                              |
| <b>interface ip_address</b> | The IP address of a security appliance network interface. Each interface IP address must be unique. Two or more interfaces must not be given the same IP address or IP addresses that are on the same IP network.                                                                                                                                                                                                                                                                                                                                                                                                                                                                                                                                                                                                                                                                                                                                                                                                                           |
| <b>interface names</b>      | Human readable name assigned to a security appliance network interface. The inside interface default name is “inside” and the outside interface default name is “outside.” Any perimeter interface default names are “intf <i>n</i> ”, such as intf2 for the first perimeter interface, intf3 for the second perimeter interface, and so on to the last interface. The numbers in the intf string corresponds to the position of the interface card in the security appliance. You can use the default names or, if you are an experienced user, give each interface a more meaningful name. See also <a href="#">inside</a> , <a href="#">intfn</a> , <a href="#">outside</a> .                                                                                                                                                                                                                                                                                                                                                            |
| <b>intfn</b>                | Any interface, usually beginning with port 2, that connects to a subset network of your design that you can custom name and configure.                                                                                                                                                                                                                                                                                                                                                                                                                                                                                                                                                                                                                                                                                                                                                                                                                                                                                                      |
| <b>interface PAT</b>        | The use of <a href="#">PAT</a> where the <a href="#">PAT</a> IP address is also the IP address of the outside interface. See <a href="#">Dynamic PAT</a> , <a href="#">Static PAT</a> .                                                                                                                                                                                                                                                                                                                                                                                                                                                                                                                                                                                                                                                                                                                                                                                                                                                     |
| <b>Internet</b>             | The global network that uses <a href="#">IP</a> . Not a <a href="#">LAN</a> . See also <a href="#">intranet</a> .                                                                                                                                                                                                                                                                                                                                                                                                                                                                                                                                                                                                                                                                                                                                                                                                                                                                                                                           |
| <b>intranet</b>             | Intranetwork. A LAN that uses <a href="#">IP</a> . See also <a href="#">network</a> and <a href="#">Internet</a> .                                                                                                                                                                                                                                                                                                                                                                                                                                                                                                                                                                                                                                                                                                                                                                                                                                                                                                                          |
| <b>IP</b>                   | Internet Protocol. IP protocols are the most popular nonproprietary protocols because they can be used to communicate across any set of interconnected networks and are equally well suited for <a href="#">LAN</a> and <a href="#">WAN</a> communications.                                                                                                                                                                                                                                                                                                                                                                                                                                                                                                                                                                                                                                                                                                                                                                                 |
| <b>IPS</b>                  | Intrusion Prevention Service. An in-line, deep-packet inspection-based solution that helps mitigate a wide range of network attacks.                                                                                                                                                                                                                                                                                                                                                                                                                                                                                                                                                                                                                                                                                                                                                                                                                                                                                                        |
| <b>IP address</b>           | An IP protocol address. A security appliance interface <a href="#">ip_address</a> . IP version 4 addresses are 32 bits in length. This address space is used to designate the network number, optional subnetwork number, and a host number. The 32 bits are grouped into four octets (8 binary bits), represented by 4 decimal numbers separated by periods, or dots. The meaning of each of the four octets is determined by their use in a particular network.                                                                                                                                                                                                                                                                                                                                                                                                                                                                                                                                                                           |
| <b>IP pool</b>              | A range of local IP addresses specified by a name, and a range with a starting IP address and an ending address. IP Pools are used by <a href="#">DHCP</a> and <a href="#">VPNs</a> to assign local IP addresses to clients on the inside interface.                                                                                                                                                                                                                                                                                                                                                                                                                                                                                                                                                                                                                                                                                                                                                                                        |

|                            |                                                                                                                                                                                                                                                                                                                                                                                                                                                                                                                                                     |
|----------------------------|-----------------------------------------------------------------------------------------------------------------------------------------------------------------------------------------------------------------------------------------------------------------------------------------------------------------------------------------------------------------------------------------------------------------------------------------------------------------------------------------------------------------------------------------------------|
| <b>IPSec</b>               | IP Security. A framework of open standards that provides data confidentiality, data integrity, and data authentication between participating peers. IPSec provides these security services at the IP layer. IPSec uses <a href="#">IKE</a> to handle the negotiation of protocols and algorithms based on local policy and to generate the encryption and authentication keys to be used by IPSec. IPSec can protect one or more data flows between a pair of hosts, between a pair of security gateways, or between a security gateway and a host. |
| <b>IPSec Phase 1</b>       | The first phase of negotiating <a href="#">IPSec</a> , includes the key exchange and the <a href="#">ISAKMP</a> portions of <a href="#">IPSec</a> .                                                                                                                                                                                                                                                                                                                                                                                                 |
| <b>IPSec Phase 2</b>       | The second phase of negotiating <a href="#">IPSec</a> . Phase two determines the type of encryption rules used for payload, the source and destination that will be used for encryption, the definition of interesting traffic according to access lists, and the <a href="#">IPSec</a> peer. <a href="#">IPSec</a> is applied to the interface in Phase 2.                                                                                                                                                                                         |
| <b>IPSec transform set</b> | A transform set specifies the <a href="#">IPSec</a> protocol, encryption algorithm, and hash algorithm to use on traffic matching the <a href="#">IPSec</a> policy. A transform describes a security protocol ( <a href="#">AH</a> or <a href="#">ESP</a> ) with its corresponding algorithms. The <a href="#">IPSec</a> protocol used in almost all transform sets is <a href="#">ESP</a> with the <a href="#">DES</a> algorithm and HMAC-SHA for authentication.                                                                                  |
| <b>ISAKMP</b>              | Internet Security Association and Key Management Protocol. A protocol framework that defines payload formats, the mechanics of implementing a key exchange protocol, and the negotiation of a security association. See <a href="#">IKE</a> .                                                                                                                                                                                                                                                                                                       |
| <b>ISP</b>                 | Internet Service Provider. An organization that provides connection to the <a href="#">Internet</a> via their services, such as modem dial in over telephone voice lines or <a href="#">DSL</a> .                                                                                                                                                                                                                                                                                                                                                   |

---

**J**

|              |                                                                                                                                    |
|--------------|------------------------------------------------------------------------------------------------------------------------------------|
| <b>JTAPI</b> | Java Telephony Application Programming Interface. A Java-based API supporting telephony functions. See also <a href="#">TAPI</a> . |
|--------------|------------------------------------------------------------------------------------------------------------------------------------|

---

**K**

|            |                                                                                                                      |
|------------|----------------------------------------------------------------------------------------------------------------------|
| <b>key</b> | A data object used for <a href="#">encryption</a> , <a href="#">decryption</a> , or <a href="#">authentication</a> . |
|------------|----------------------------------------------------------------------------------------------------------------------|

---

**L**

|                      |                                                                                                                                                                                                                                                                           |
|----------------------|---------------------------------------------------------------------------------------------------------------------------------------------------------------------------------------------------------------------------------------------------------------------------|
| <b>LAN</b>           | Local area network. A network residing in one location, such as a single building or campus. See also <a href="#">Internet</a> , <a href="#">intranet</a> , and <a href="#">network</a> .                                                                                 |
| <b>layer, layers</b> | Networking models implement layers with which different protocols are associated. The most common networking model is the OSI model, which consists of the following 7 layers, in order: physical, data link, network, transport, session, presentation, and application. |
| <b>LCN</b>           | Logical channel number.                                                                                                                                                                                                                                                   |
| <b>LDAP</b>          | Lightweight Directory Access Protocol. LDAP provides management and browser applications with access to X.500 directories.                                                                                                                                                |

---

**M**

|                                 |                                                                                                                                                                                                                                                                                                                                                                                                                                                                                                                                                                                                              |
|---------------------------------|--------------------------------------------------------------------------------------------------------------------------------------------------------------------------------------------------------------------------------------------------------------------------------------------------------------------------------------------------------------------------------------------------------------------------------------------------------------------------------------------------------------------------------------------------------------------------------------------------------------|
| <b>mask</b>                     | A 32-bit mask that shows how an <a href="#">Internet</a> address is divided into network, subnet, and host parts. The mask has ones in the bit positions to be used for the network and subnet parts, and zeros for the host part. The mask should contain at least the standard network portion, and the subnet field should be contiguous with the network portion.                                                                                                                                                                                                                                        |
| <b>MCR</b>                      | See <a href="#">multicast</a> .                                                                                                                                                                                                                                                                                                                                                                                                                                                                                                                                                                              |
| <b>MC router</b>                | Multicast (MC) routers route multicast data transmissions to the hosts on each LAN in an internetwork that are registered to receive specific multimedia or other broadcasts. See also <a href="#">multicast</a> .                                                                                                                                                                                                                                                                                                                                                                                           |
| <b>MD5</b>                      | Message Digest 5. A one-way hashing algorithm that produces a 128-bit hash. Both MD5 and <a href="#">SHA-1</a> are variations on MD4 and are designed to strengthen the security of the MD4 hashing algorithm. <a href="#">SHA-1</a> is more secure than MD4 and MD5. Cisco uses hashes for authentication within the <a href="#">IPSec</a> framework. Also used for message authentication in SNMP v.2. MD5 verifies the integrity of the communication, authenticates the origin, and checks for timeliness. MD5 has a smaller digest and is considered to be slightly faster than <a href="#">SHA-1</a> . |
| <b>MDI</b>                      | Media dependent interface.                                                                                                                                                                                                                                                                                                                                                                                                                                                                                                                                                                                   |
| <b>MDIX</b>                     | Media dependent interface crossover.                                                                                                                                                                                                                                                                                                                                                                                                                                                                                                                                                                         |
| <b>Message Digest</b>           | A message digest is created by a hash algorithm, such as <a href="#">MD5</a> or <a href="#">SHA-1</a> , that is used for ensuring message integrity.                                                                                                                                                                                                                                                                                                                                                                                                                                                         |
| <b>MGCP</b>                     | Media Gateway Control Protocol. Media Gateway Control Protocol is a protocol for the control of VoIP calls by external call-control elements known as media gateway controllers or call agents. MGCP merges the IPDC and <a href="#">SGCP</a> protocols.                                                                                                                                                                                                                                                                                                                                                     |
| <b>Mode</b>                     | See <a href="#">Access Modes</a> .                                                                                                                                                                                                                                                                                                                                                                                                                                                                                                                                                                           |
| <b>Mode Config</b>              | See <a href="#">IKE Mode Configuration</a> .                                                                                                                                                                                                                                                                                                                                                                                                                                                                                                                                                                 |
| <b>Modular Policy Framework</b> | Modular Policy Framework. A means of configuring security appliance features in a manner to similar to Cisco IOS software Modular <a href="#">QoS CLI</a> .                                                                                                                                                                                                                                                                                                                                                                                                                                                  |
| <b>MS</b>                       | mobile station. Refers generically to any mobile device, such as a mobile handset or computer, that is used to access network services. <a href="#">GPRS</a> networks support three classes of MS, which describe the type of operation supported within the <a href="#">GPRS</a> and the <a href="#">GSM</a> mobile wireless networks. For example, a Class A MS supports simultaneous operation of <a href="#">GPRS</a> and <a href="#">GSM</a> services.                                                                                                                                                  |
| <b>MS-CHAP</b>                  | Microsoft <a href="#">CHAP</a> .                                                                                                                                                                                                                                                                                                                                                                                                                                                                                                                                                                             |
| <b>MTU</b>                      | Maximum transmission unit, the maximum number of bytes in a packet that can flow efficiently across the network with best response time. For Ethernet, the default MTU is 1500 bytes, but each network can have different values, with serial connections having the smallest values. The MTU is described in RFC 1191.                                                                                                                                                                                                                                                                                      |
| <b>multicast</b>                | Multicast refers to a network addressing method in which the source transmits a packet to multiple destinations, a multicast group, simultaneously. See also <a href="#">PIM</a> , <a href="#">SMR</a> .                                                                                                                                                                                                                                                                                                                                                                                                     |

---

**N**

- N2H2** A third-party, policy-oriented filtering application that works with the security appliance to control user web access. N2H2 can filter [HTTP](#) requests based on destination host name, destination IP address, and username and password. The N2H2 corporation was acquired by Secure Computing in October, 2003.
- NAT** Network Address Translation. Mechanism for reducing the need for globally unique IP addresses. NAT allows an organization with addresses that are not globally unique to connect to the [Internet](#) by translating those addresses into a globally routable address space.
- NEM** Network Extension Mode. Lets [VPN](#) hardware clients present a single, routable network to the remote private network over the [VPN](#) tunnel.
- NetBIOS** Network Basic Input/Output System. A Microsoft protocol that supports Windows host name registration, session management, and data transfer. The security appliance supports NetBIOS by performing [NAT](#) of the packets for NBNS UDP port 137 and NBDS UDP port 138.
- netmask** See [mask](#).
- network** In the context of security appliance configuration, a network is a group of computing devices that share part of an IP address space and not a single host. A network consists of multiple nodes or hosts. See also [host](#), [Internet](#), [intranet](#), [IP](#), [LAN](#), and [node](#).
- NMS** network management system. System responsible for managing at least part of a network. An NMS is generally a reasonably powerful and well-equipped computer, such as an engineering workstation. NMSs communicate with agents to help keep track of network statistics and resources.
- node** Devices such as routers and printers that would not normally be called hosts. See also [host](#), [network](#).
- nonvolatile storage, memory** Storage or memory that, unlike RAM, retains its contents without power. Data in a nonvolatile storage device survives a power-off, power-on cycle or reboot.
- NSAPI** Network service access point identifier. One of two components of a [GTP](#) tunnel ID, the other component being the [IMSI](#). See also [IMSI](#).
- NSSA** Not-so-stubby-area. An OSPF feature described by RFC 1587. NSSA was first introduced in Cisco IOS software release 11.2. It is a non-proprietary extension of the existing stub area feature that allows the injection of external routes in a limited fashion into the stub area.
- NTLM** NT Lan Manager. A Microsoft Windows challenge-response authentication method.
- NTP** Network time protocol.

---

**O**

- Oakley** A key exchange protocol that defines how to acquire authenticated keying material. The basic mechanism for Oakley is the [Diffie-Hellman](#) key exchange algorithm. Oakley is defined in RFC 2412.
- object grouping** Simplifies access control by letting you apply access control statements to groups of network objects, such as protocol, services, hosts, and networks.



|                     |                                                                                                                                                                                                                                                                                                                                                                                                                                                                                                                                                                                                                                                                                                                                                                                                                                                                                                                                                                                                   |
|---------------------|---------------------------------------------------------------------------------------------------------------------------------------------------------------------------------------------------------------------------------------------------------------------------------------------------------------------------------------------------------------------------------------------------------------------------------------------------------------------------------------------------------------------------------------------------------------------------------------------------------------------------------------------------------------------------------------------------------------------------------------------------------------------------------------------------------------------------------------------------------------------------------------------------------------------------------------------------------------------------------------------------|
| <b>OSPF</b>         | Open Shortest Path First. OSPF is a routing protocol for IP networks. OSPF is a routing protocol widely deployed in large networks because of its efficient use of network bandwidth and its rapid convergence after changes in topology. The security appliance supports OSPF.                                                                                                                                                                                                                                                                                                                                                                                                                                                                                                                                                                                                                                                                                                                   |
| <b>OU</b>           | Organizational Unit. An X.500 directory attribute.                                                                                                                                                                                                                                                                                                                                                                                                                                                                                                                                                                                                                                                                                                                                                                                                                                                                                                                                                |
| <b>outbound</b>     | Refers to traffic whose destination is on an interface with lower security than the source interface.                                                                                                                                                                                                                                                                                                                                                                                                                                                                                                                                                                                                                                                                                                                                                                                                                                                                                             |
| <b>outbound ACL</b> | An <a href="#">ACL</a> applied to outbound traffic.                                                                                                                                                                                                                                                                                                                                                                                                                                                                                                                                                                                                                                                                                                                                                                                                                                                                                                                                               |
| <b>outside</b>      | The first interface, usually port 0, that connects to other “untrusted” networks outside the security appliance; the <a href="#">Internet</a> . See also <a href="#">interface</a> , <a href="#">interface names</a> , <a href="#">outbound</a> .                                                                                                                                                                                                                                                                                                                                                                                                                                                                                                                                                                                                                                                                                                                                                 |
| <hr/>               |                                                                                                                                                                                                                                                                                                                                                                                                                                                                                                                                                                                                                                                                                                                                                                                                                                                                                                                                                                                                   |
| <b>P</b>            |                                                                                                                                                                                                                                                                                                                                                                                                                                                                                                                                                                                                                                                                                                                                                                                                                                                                                                                                                                                                   |
| <b>PAC</b>          | <a href="#">PPTP</a> Access Concentrator. A device attached to one or more PSTN or ISDN lines capable of <a href="#">PPP</a> operation and of handling the <a href="#">PPTP</a> protocol. The PAC need only implement TCP/IP to pass traffic to one or more <a href="#">PNS</a> s. It may also tunnel non-IP protocols.                                                                                                                                                                                                                                                                                                                                                                                                                                                                                                                                                                                                                                                                           |
| <b>PAT</b>          | See <a href="#">Dynamic PAT</a> , <a href="#">interface PAT</a> , and <a href="#">Static PAT</a> .                                                                                                                                                                                                                                                                                                                                                                                                                                                                                                                                                                                                                                                                                                                                                                                                                                                                                                |
| <b>PDP</b>          | Packet Data Protocol.                                                                                                                                                                                                                                                                                                                                                                                                                                                                                                                                                                                                                                                                                                                                                                                                                                                                                                                                                                             |
| <b>Perfmon</b>      | The security appliance feature that gathers and reports a wide variety of feature statistics, such as connections/second, xlates/second, etc.                                                                                                                                                                                                                                                                                                                                                                                                                                                                                                                                                                                                                                                                                                                                                                                                                                                     |
| <b>PFS</b>          | Perfect Forwarding Secrecy. PFS enhances security by using different security key for the <a href="#">IPSec</a> Phase 1 and Phase 2 <a href="#">SAs</a> . Without PFS, the same security key is used to establish <a href="#">SAs</a> in both phases. PFS ensures that a given <a href="#">IPSec SA</a> key was not derived from any other secret (like some other keys). In other words, if someone were to break a key, PFS ensures that the attacker would not be able to derive any other key. If PFS were not enabled, someone could hypothetically break the <a href="#">IKE SA</a> secret key, copy all the <a href="#">IPSec</a> protected data, and then use knowledge of the <a href="#">IKE SA</a> secret to compromise the <a href="#">IPSec SA</a> setup by this <a href="#">IKE SA</a> . With PFS, breaking <a href="#">IKE</a> would not give an attacker immediate access to <a href="#">IPSec</a> . The attacker would have to break each <a href="#">IPSec SA</a> individually. |
| <b>Phase 1</b>      | See <a href="#">IPSec Phase 1</a> .                                                                                                                                                                                                                                                                                                                                                                                                                                                                                                                                                                                                                                                                                                                                                                                                                                                                                                                                                               |
| <b>Phase 2</b>      | See <a href="#">IPSec Phase 2</a> .                                                                                                                                                                                                                                                                                                                                                                                                                                                                                                                                                                                                                                                                                                                                                                                                                                                                                                                                                               |
| <b>PIM</b>          | Protocol Independent Multicast. PIM provides a scalable method for determining the best paths for distributing a specific multicast transmission to a group of hosts. Each host has registered using <a href="#">IGMP</a> to receive the transmission. See also <a href="#">PIM-SM</a> .                                                                                                                                                                                                                                                                                                                                                                                                                                                                                                                                                                                                                                                                                                          |
| <b>PIM-SM</b>       | Protocol Independent Multicast-Sparse Mode. With PIM-SM, which is the default for Cisco routers, when the source of a multicast transmission begins broadcasting, the traffic is forwarded from one MC router to the next, until the packets reach every registered host. See also <a href="#">PIM</a> .                                                                                                                                                                                                                                                                                                                                                                                                                                                                                                                                                                                                                                                                                          |
| <b>Ping</b>         | An <a href="#">ICMP</a> request sent by a host to determine if a second host is accessible.                                                                                                                                                                                                                                                                                                                                                                                                                                                                                                                                                                                                                                                                                                                                                                                                                                                                                                       |

|                        |                                                                                                                                                                                                                                                                                                                                                                                                                                                                                                                                                                                                   |
|------------------------|---------------------------------------------------------------------------------------------------------------------------------------------------------------------------------------------------------------------------------------------------------------------------------------------------------------------------------------------------------------------------------------------------------------------------------------------------------------------------------------------------------------------------------------------------------------------------------------------------|
| <b>PIX</b>             | Private Internet eXchange. The Cisco PIX 500-series security appliances range from compact, plug-and-play desktop models for small/home offices to carrier-class gigabit models for the most demanding enterprise and service provider environments. Cisco PIX security appliances provide robust, enterprise-class integrated network security services to create a strong multilayered defense for fast changing network environments.                                                                                                                                                          |
| <b>PKCS12</b>          | A standard for the transfer of PKI-related data, such as private keys, certificates, and other data. Devices supporting this standard let administrators maintain a single set of personal identity information.                                                                                                                                                                                                                                                                                                                                                                                  |
| <b>PNS</b>             | <a href="#">PPTP</a> Network Server. A PNS is envisioned to operate on general-purpose computing/server platforms. The PNS handles the server side of <a href="#">PPTP</a> . Because <a href="#">PPTP</a> relies completely on TCP/IP and is independent of the interface hardware, the PNS may use any combination of IP interface hardware including <a href="#">LAN</a> and <a href="#">WAN</a> devices.                                                                                                                                                                                       |
| <b>Policy NAT</b>      | Lets you identify local traffic for address translation by specifying the source and destination addresses (or ports) in an access list.                                                                                                                                                                                                                                                                                                                                                                                                                                                          |
| <b>POP</b>             | Post Office Protocol. Protocol that client e-mail applications use to retrieve mail from a mail server.                                                                                                                                                                                                                                                                                                                                                                                                                                                                                           |
| <b>Pool</b>            | See <a href="#">IP pool</a> .                                                                                                                                                                                                                                                                                                                                                                                                                                                                                                                                                                     |
| <b>Port</b>            | A field in the packet headers of <a href="#">TCP</a> and <a href="#">UDP</a> protocols that identifies the higher level service which is the source or destination of the packet.                                                                                                                                                                                                                                                                                                                                                                                                                 |
| <b>PPP</b>             | Point-to-Point Protocol. Developed for dial-up <a href="#">ISP</a> access using analog phone lines and modems.                                                                                                                                                                                                                                                                                                                                                                                                                                                                                    |
| <b>PPTP</b>            | Point-to-Point Tunneling Protocol. PPTP was introduced by Microsoft to provide secure remote access to Windows networks; however, because it is vulnerable to attack, PPTP is commonly used only when stronger security methods are not available or are not required. PPTP Ports are pptp, 1723/tcp, 1723/udp, and pptp. For more information about PPTP, see RFC 2637. See also <a href="#">PAC</a> , <a href="#">PPTP GRE</a> , <a href="#">PPTP GRE tunnel</a> , <a href="#">PNS</a> , <a href="#">PPTP session</a> , and <a href="#">PPTP TCP</a> .                                          |
| <b>PPTP GRE</b>        | Version 1 of GRE for encapsulating PPP traffic.                                                                                                                                                                                                                                                                                                                                                                                                                                                                                                                                                   |
| <b>PPTP GRE tunnel</b> | A tunnel defined by a <a href="#">PNS-PAC</a> pair. The tunnel protocol is defined by a modified version of <a href="#">GRE</a> . The tunnel carries <a href="#">PPP</a> datagrams between the <a href="#">PAC</a> and the <a href="#">PNS</a> . Many sessions are multiplexed on a single tunnel. A control connection operating over <a href="#">TCP</a> controls the establishment, release, and maintenance of sessions and of the tunnel itself.                                                                                                                                             |
| <b>PPTP session</b>    | <a href="#">PPTP</a> is connection-oriented. The <a href="#">PNS</a> and <a href="#">PAC</a> maintain state for each user that is attached to a <a href="#">PAC</a> . A session is created when end-to-end <a href="#">PPP</a> connection is attempted between a dial user and the <a href="#">PNS</a> . The datagrams related to a session are sent over the tunnel between the <a href="#">PAC</a> and <a href="#">PNS</a> .                                                                                                                                                                    |
| <b>PPTP TCP</b>        | Standard <a href="#">TCP</a> session over which <a href="#">PPTP</a> call control and management information is passed. The control session is logically associated with, but separate from, the sessions being tunneled through a <a href="#">PPTP</a> tunnel.                                                                                                                                                                                                                                                                                                                                   |
| <b>preshared key</b>   | A preshared key provides a method of <a href="#">IKE</a> authentication that is suitable for networks with a limited, static number of <a href="#">IPSec</a> peers. This method is limited in scalability because the key must be configured for each pair of <a href="#">IPSec</a> peers. When a new <a href="#">IPSec</a> peer is added to the network, the preshared key must be configured for every <a href="#">IPSec</a> peer with which it communicates. Using <a href="#">certificates</a> and <a href="#">CAs</a> provides a more scalable method of <a href="#">IKE</a> authentication. |

|                                    |                                                                                                                                                                                                                                                                                                                                                                                                                                                                                                                                |
|------------------------------------|--------------------------------------------------------------------------------------------------------------------------------------------------------------------------------------------------------------------------------------------------------------------------------------------------------------------------------------------------------------------------------------------------------------------------------------------------------------------------------------------------------------------------------|
| <b>primary, primary unit</b>       | The security appliance normally operating when two units, a primary and secondary, are operating in failover mode.                                                                                                                                                                                                                                                                                                                                                                                                             |
| <b>privileged EXEC mode</b>        | Privileged EXEC mode lets you to change current settings. Any user EXEC mode command will work in privileged EXEC mode. See also <a href="#">command-specific configuration mode</a> , <a href="#">global configuration mode</a> , <a href="#">user EXEC mode</a> .                                                                                                                                                                                                                                                            |
| <b>protocol, protocol literals</b> | A standard that defines the exchange of packets between network nodes for communication. Protocols work together in layers. Protocols are specified in a security appliance configuration as part of defining a security policy by their literal values or port numbers. Possible security appliance protocol literal values are ahp, eigrp, esp, gre, icmp, igmp, igmp, ip, ipinip, ipsec, nos, ospf, pcp, snp, tcp, and udp.                                                                                                 |
| <b>Proxy-ARP</b>                   | Enables the security appliance to reply to an <a href="#">ARP</a> request for IP addresses in the global pool. See also <a href="#">ARP</a> .                                                                                                                                                                                                                                                                                                                                                                                  |
| <b>public key</b>                  | A public key is one of a pair of keys that are generated by devices involved in public key infrastructure. Data encrypted with a public key can only be decrypted using the associated private key. When a private key is used to produce a digital signature, the receiver can use the public key of the sender to verify that the message was signed by the sender. These characteristics of key pairs provide a scalable and secure method of authentication over an insecure media, such as the <a href="#">Internet</a> . |
| <hr/>                              |                                                                                                                                                                                                                                                                                                                                                                                                                                                                                                                                |
| <b>Q</b>                           |                                                                                                                                                                                                                                                                                                                                                                                                                                                                                                                                |
| <b>QoS</b>                         | quality of service. Measure of performance for a transmission system that reflects its transmission quality and service availability.                                                                                                                                                                                                                                                                                                                                                                                          |
| <hr/>                              |                                                                                                                                                                                                                                                                                                                                                                                                                                                                                                                                |
| <b>R</b>                           |                                                                                                                                                                                                                                                                                                                                                                                                                                                                                                                                |
| <b>RA</b>                          | Registration Authority. An authorized proxy for a <a href="#">CA</a> . RAs can perform certificate enrollment and can issue <a href="#">CRLs</a> . See also <a href="#">CA</a> , <a href="#">certificate</a> , <a href="#">public key</a> .                                                                                                                                                                                                                                                                                    |
| <b>RADIUS</b>                      | Remote Authentication Dial-In User Service. RADIUS is a distributed client/server system that secures networks against unauthorized access. RFC 2058 and RFC 2059 define the RADIUS protocol standard. See also <a href="#">AAA</a> and <a href="#">TACACS+</a> .                                                                                                                                                                                                                                                              |
| <b>Refresh</b>                     | Retrieve the running configuration from the security appliance and update the screen. The icon and the button perform the same function.                                                                                                                                                                                                                                                                                                                                                                                       |
| <b>registration authority</b>      | See <a href="#">RA</a> .                                                                                                                                                                                                                                                                                                                                                                                                                                                                                                       |
| <b>replay-detection</b>            | A security service where the receiver can reject old or duplicate packets to defeat replay attacks. Replay attacks rely on the attacker sending out older or duplicate packets to the receiver and the receiver thinking that the bogus traffic is legitimate. Replay-detection is done by using sequence numbers combined with authentication, and is a standard feature of <a href="#">IPSec</a> .                                                                                                                           |
| <b>RFC</b>                         | Request for Comments. RFC documents define protocols and standards for communications over the <a href="#">Internet</a> . RFCs are developed and published by <a href="#">IETF</a> .                                                                                                                                                                                                                                                                                                                                           |

|                              |                                                                                                                                                                                                                                                                                                                                                                                                                                                                                                                                                                                                                                                                                                                                                             |
|------------------------------|-------------------------------------------------------------------------------------------------------------------------------------------------------------------------------------------------------------------------------------------------------------------------------------------------------------------------------------------------------------------------------------------------------------------------------------------------------------------------------------------------------------------------------------------------------------------------------------------------------------------------------------------------------------------------------------------------------------------------------------------------------------|
| <b>RIP</b>                   | Routing Information Protocol. Interior gateway protocol (IGP) supplied with UNIX BSD systems. The most common IGP in the <a href="#">Internet</a> . RIP uses hop count as a routing metric.                                                                                                                                                                                                                                                                                                                                                                                                                                                                                                                                                                 |
| <b>RLLA</b>                  | Reserved Link Local Address. Multicast addresses range from 224.0.0.0 to 239.255.255.255, however only the range 224.0.1.0 to 239.255.255.255 is available to us. The first part of the multicast address range, 224.0.0.0 to 224.0.0.255, is reserved and referred to as the RLLA. These addresses are unavailable. We can exclude the RLLA range by specifying: 224.0.1.0 to 239.255.255.255. 224.0.0.0 to 239.255.255.255 excluding 224.0.0.0 to 224.0.0.255. This is the same as specifying: 224.0.1.0 to 239.255.255.255.                                                                                                                                                                                                                              |
| <b>route, routing</b>        | The path through a <a href="#">network</a> .                                                                                                                                                                                                                                                                                                                                                                                                                                                                                                                                                                                                                                                                                                                |
| <b>routed firewall mode</b>  | In routed firewall mode, the security appliance is counted as a router hop in the network. It performs <a href="#">NAT</a> between connected networks and can use <a href="#">OSPF</a> or <a href="#">RIP</a> . See also <a href="#">transparent firewall mode</a> .                                                                                                                                                                                                                                                                                                                                                                                                                                                                                        |
| <b>RPC</b>                   | Remote Procedure Call. RPCs are procedure calls that are built or specified by clients and executed on servers, with the results returned over the network to the clients.                                                                                                                                                                                                                                                                                                                                                                                                                                                                                                                                                                                  |
| <b>RSA</b>                   | A <a href="#">public key</a> cryptographic algorithm (named after its inventors, Rivest, Shamir, and Adelman) with a variable key length. The main weakness of RSA is that it is significantly slow to compute compared to popular secret-key algorithms, such as <a href="#">DES</a> . The Cisco implementation of <a href="#">IKE</a> uses a <a href="#">Diffie-Hellman</a> exchange to get the secret keys. This exchange can be authenticated with RSA (or preshared keys). With the <a href="#">Diffie-Hellman</a> exchange, the <a href="#">DES</a> key never crosses the network (not even in encrypted form), which is not the case with the RSA encrypt and sign technique. RSA is not public domain, and must be licensed from RSA Data Security. |
| <b>RSH</b>                   | Remote Shell. A protocol that allows a user to execute commands on a remote system without having to log in to the system. For example, RSH can be used to remotely examine the status of a number of access servers without connecting to each communication server, executing the command, and then disconnecting from the communication server.                                                                                                                                                                                                                                                                                                                                                                                                          |
| <b>RTCP</b>                  | RTP Control Protocol. Protocol that monitors the <a href="#">QoS</a> of an IPv6 <a href="#">RTP</a> connection and conveys information about the on-going session. See also <a href="#">RTP</a> .                                                                                                                                                                                                                                                                                                                                                                                                                                                                                                                                                           |
| <b>RTP</b>                   | Real-Time Transport Protocol. Commonly used with IP networks. RTP is designed to provide end-to-end network transport functions for applications transmitting real-time data, such as audio, video, or simulation data, over multicast or unicast network services. RTP provides such services as payload type identification, sequence numbering, timestamping, and delivery monitoring to real-time applications.                                                                                                                                                                                                                                                                                                                                         |
| <b>RTSP</b>                  | Real Time Streaming Protocol. Enables the controlled delivery of real-time data, such as audio and video. RTSP is designed to work with established protocols, such as <a href="#">RTP</a> and <a href="#">HTTP</a> .                                                                                                                                                                                                                                                                                                                                                                                                                                                                                                                                       |
| <b>rule</b>                  | Conditional statements added to the security appliance configuration to define security policy for a particular situation. See also <a href="#">ACE</a> , <a href="#">ACL</a> , <a href="#">NAT</a> .                                                                                                                                                                                                                                                                                                                                                                                                                                                                                                                                                       |
| <b>running configuration</b> | The configuration currently running in RAM on the security appliance. The configuration that determines the operational characteristics of the security appliance.                                                                                                                                                                                                                                                                                                                                                                                                                                                                                                                                                                                          |

---

**S**

|                            |                                                                                                                                                                                                                                                                                                                                                                                                                                                                                                                                                                                                                                                                                                                                                                                                                                                                                                                                                                                                                                                                                                                                                                                                                                                                                                                                                                                                                           |
|----------------------------|---------------------------------------------------------------------------------------------------------------------------------------------------------------------------------------------------------------------------------------------------------------------------------------------------------------------------------------------------------------------------------------------------------------------------------------------------------------------------------------------------------------------------------------------------------------------------------------------------------------------------------------------------------------------------------------------------------------------------------------------------------------------------------------------------------------------------------------------------------------------------------------------------------------------------------------------------------------------------------------------------------------------------------------------------------------------------------------------------------------------------------------------------------------------------------------------------------------------------------------------------------------------------------------------------------------------------------------------------------------------------------------------------------------------------|
| <b>SA</b>                  | security association. An instance of security policy and keying material applied to a data flow. SAs are established in pairs by <a href="#">IPSec</a> peers during both phases of <a href="#">IPSec</a> . SAs specify the encryption algorithms and other security parameters used to create a secure tunnel. Phase 1 SAs ( <a href="#">IKE</a> SAs) establish a secure tunnel for negotiating Phase 2 SAs. Phase 2 SAs ( <a href="#">IPSec</a> SAs) establish the secure tunnel used for sending user data. Both <a href="#">IKE</a> and <a href="#">IPSec</a> use SAs, although SAs are independent of one another. <a href="#">IPSec</a> SAs are unidirectional and they are unique in each security protocol. A set of SAs are needed for a protected data pipe, one per direction per protocol. For example, if you have a pipe that supports <a href="#">ESP</a> between peers, one <a href="#">ESP</a> SA is required for each direction. SAs are uniquely identified by destination ( <a href="#">IPSec</a> endpoint) address, security protocol ( <a href="#">AH</a> or <a href="#">ESP</a> ), and Security Parameter Index. <a href="#">IKE</a> negotiates and establishes SAs on behalf of <a href="#">IPSec</a> . A user can also establish <a href="#">IPSec</a> SAs manually. An <a href="#">IKE</a> SA is used by <a href="#">IKE</a> only, and unlike the <a href="#">IPSec</a> SA, it is bidirectional. |
| <b>SCCP</b>                | SkinnY Client Control Protocol. A Cisco-proprietary protocol used between Cisco Call Manager and Cisco <a href="#">VoIP</a> phones.                                                                                                                                                                                                                                                                                                                                                                                                                                                                                                                                                                                                                                                                                                                                                                                                                                                                                                                                                                                                                                                                                                                                                                                                                                                                                       |
| <b>SCEP</b>                | Simple Certificate Enrollment Protocol. A method of requesting and receiving (also known as enrolling) certificates from <a href="#">CAs</a> .                                                                                                                                                                                                                                                                                                                                                                                                                                                                                                                                                                                                                                                                                                                                                                                                                                                                                                                                                                                                                                                                                                                                                                                                                                                                            |
| <b>SDP</b>                 | Session Definition Protocol. An <a href="#">IETF</a> protocol for the definition of Multimedia Services. SDP messages can be part of <a href="#">SGCP</a> and <a href="#">MGCP</a> messages.                                                                                                                                                                                                                                                                                                                                                                                                                                                                                                                                                                                                                                                                                                                                                                                                                                                                                                                                                                                                                                                                                                                                                                                                                              |
| <b>secondary unit</b>      | The backup security appliance when two are operating in failover mode.                                                                                                                                                                                                                                                                                                                                                                                                                                                                                                                                                                                                                                                                                                                                                                                                                                                                                                                                                                                                                                                                                                                                                                                                                                                                                                                                                    |
| <b>secret key</b>          | A secret key is a key shared only between the sender and receiver. See <a href="#">key</a> , <a href="#">public key</a> .                                                                                                                                                                                                                                                                                                                                                                                                                                                                                                                                                                                                                                                                                                                                                                                                                                                                                                                                                                                                                                                                                                                                                                                                                                                                                                 |
| <b>security context</b>    | You can partition a single security appliance into multiple virtual firewalls, known as security contexts. Each context is an independent firewall, with its own security policy, interfaces, and administrators. Multiple contexts are similar to having multiple stand-alone firewalls.                                                                                                                                                                                                                                                                                                                                                                                                                                                                                                                                                                                                                                                                                                                                                                                                                                                                                                                                                                                                                                                                                                                                 |
| <b>security services</b>   | See <a href="#">cryptography</a> .                                                                                                                                                                                                                                                                                                                                                                                                                                                                                                                                                                                                                                                                                                                                                                                                                                                                                                                                                                                                                                                                                                                                                                                                                                                                                                                                                                                        |
| <b>serial transmission</b> | A method of data transmission in which the bits of a data character are transmitted sequentially over a single channel.                                                                                                                                                                                                                                                                                                                                                                                                                                                                                                                                                                                                                                                                                                                                                                                                                                                                                                                                                                                                                                                                                                                                                                                                                                                                                                   |
| <b>SGCP</b>                | Simple Gateway Control Protocol. Controls <a href="#">VoIP</a> gateways by an external call control element (called a call-agent).                                                                                                                                                                                                                                                                                                                                                                                                                                                                                                                                                                                                                                                                                                                                                                                                                                                                                                                                                                                                                                                                                                                                                                                                                                                                                        |
| <b>SGSN</b>                | Serving GPRS Support Node. The SGSN ensures mobility management, session management and packet relaying functions.                                                                                                                                                                                                                                                                                                                                                                                                                                                                                                                                                                                                                                                                                                                                                                                                                                                                                                                                                                                                                                                                                                                                                                                                                                                                                                        |
| <b>SHA-1</b>               | Secure Hash Algorithm 1. SHA-1 [NIST94c] is a revision to SHA that was published in 1994. SHA is closely modeled after MD4 and produces a 160-bit digest. Because SHA produces a 160-bit digest, it is more resistant to brute-force attacks than 128-bit hashes (such as <a href="#">MD5</a> ), but it is slower. Secure Hash Algorithm 1 is a joint creation of the National Institute of Standards and Technology and the National Security Agency. This algorithm, like other hash algorithms, is used to generate a hash value, also known as a message digest, that acts like a <a href="#">CRC</a> used in lower-layer protocols to ensure that message contents are not changed during transmission. SHA-1 is generally considered more secure than <a href="#">MD5</a> .                                                                                                                                                                                                                                                                                                                                                                                                                                                                                                                                                                                                                                         |

|                            |                                                                                                                                                                                                                                                                                                                                                                                                                                                                                                                                                                                                                                                                                                                                                                                                                                                                                                            |
|----------------------------|------------------------------------------------------------------------------------------------------------------------------------------------------------------------------------------------------------------------------------------------------------------------------------------------------------------------------------------------------------------------------------------------------------------------------------------------------------------------------------------------------------------------------------------------------------------------------------------------------------------------------------------------------------------------------------------------------------------------------------------------------------------------------------------------------------------------------------------------------------------------------------------------------------|
| <b>SIP</b>                 | Session Initiation Protocol. Enables call handling sessions, particularly two-party audio conferences, or “calls.” SIP works with <a href="#">SDP</a> for call signaling. <a href="#">SDP</a> specifies the ports for the media stream. Using SIP, the security appliance can support any SIP <a href="#">VoIP</a> gateways and <a href="#">VoIP</a> proxy servers.                                                                                                                                                                                                                                                                                                                                                                                                                                                                                                                                        |
| <b>site-to-site VPN</b>    | A site-to-site <a href="#">VPN</a> is established between two <a href="#">IPSec</a> peers that connect remote networks into a single <a href="#">VPN</a> . In this type of <a href="#">VPN</a> , neither <a href="#">IPSec</a> peer is the destination or source of user traffic. Instead, each <a href="#">IPSec</a> peer provides encryption and authentication services for hosts on the <a href="#">LANs</a> connected to each <a href="#">IPSec</a> peer. The hosts on each <a href="#">LAN</a> send and receive data through the secure tunnel established by the pair of <a href="#">IPSec</a> peers.                                                                                                                                                                                                                                                                                               |
| <b>SKEME</b>               | A key exchange protocol that defines how to derive authenticated keying material, with rapid key refreshment.                                                                                                                                                                                                                                                                                                                                                                                                                                                                                                                                                                                                                                                                                                                                                                                              |
| <b>SMR</b>                 | Stub Multicast Routing. SMR allows the security appliance to function as a “stub router.” A stub router is a device that acts as an <a href="#">IGMP</a> proxy agent. <a href="#">IGMP</a> is used to dynamically register specific hosts in a multicast group on a particular <a href="#">LAN</a> with a multicast router. Multicast routers route multicast data transmissions to hosts that are registered to receive specific multimedia or other broadcasts. A stub router forwards <a href="#">IGMP</a> messages between hosts and <a href="#">MC routers</a> .                                                                                                                                                                                                                                                                                                                                      |
| <b>SMTP</b>                | Simple Mail Transfer Protocol. SMTP is an Internet protocol that supports email services.                                                                                                                                                                                                                                                                                                                                                                                                                                                                                                                                                                                                                                                                                                                                                                                                                  |
| <b>SNMP</b>                | Simple Network Management Protocol. A standard method for managing network devices using data structures called Management Information Bases.                                                                                                                                                                                                                                                                                                                                                                                                                                                                                                                                                                                                                                                                                                                                                              |
| <b>split tunneling</b>     | Allows a remote <a href="#">VPN</a> client simultaneous encrypted access to a private network and clear unencrypted access to the <a href="#">Internet</a> . If you do not enable split tunneling, all traffic between the <a href="#">VPN</a> client and the security appliance is sent through an <a href="#">IPSec</a> tunnel. All traffic originating from the <a href="#">VPN</a> client is sent to the outside interface through a tunnel, and client access to the <a href="#">Internet</a> from its remote site is denied.                                                                                                                                                                                                                                                                                                                                                                         |
| <b>spoofing</b>            | A type of attack designed to foil network security mechanisms such as filters and access lists. A spoofing attack sends a packet that claims to be from an address from which it was not actually sent.                                                                                                                                                                                                                                                                                                                                                                                                                                                                                                                                                                                                                                                                                                    |
| <b>SQL*Net</b>             | Structured Query Language Protocol. An Oracle protocol used to communicate between client and server processes.                                                                                                                                                                                                                                                                                                                                                                                                                                                                                                                                                                                                                                                                                                                                                                                            |
| <b>SSH</b>                 | Secure Shell. An application running on top of a reliable transport layer, such as TCP/IP, that provides strong authentication and encryption capabilities.                                                                                                                                                                                                                                                                                                                                                                                                                                                                                                                                                                                                                                                                                                                                                |
| <b>SSL</b>                 | Secure Sockets Layer. A protocol that resides between the application layer and TCP/IP to provide transparent encryption of data traffic.                                                                                                                                                                                                                                                                                                                                                                                                                                                                                                                                                                                                                                                                                                                                                                  |
| <b>standby unit</b>        | See <a href="#">secondary unit</a> .                                                                                                                                                                                                                                                                                                                                                                                                                                                                                                                                                                                                                                                                                                                                                                                                                                                                       |
| <b>stateful inspection</b> | Network protocols maintain certain data, called state information, at each end of a network connection between two hosts. State information is necessary to implement the features of a protocol, such as guaranteed packet delivery, data sequencing, flow control, and transaction or session IDs. Some of the protocol state information is sent in each packet while each protocol is being used. For example, a browser connected to a web server uses <a href="#">HTTP</a> and supporting TCP/IP protocols. Each protocol layer maintains state information in the packets it sends and receives. The security appliance and some other firewalls inspect the state information in each packet to verify that it is current and valid for every protocol it contains. This is called stateful inspection and is designed to create a powerful barrier to certain types of computer security threats. |

|                               |                                                                                                                                                                                                                                                                                                                                                                                                                                                                                                                                                                                                                                                                                                                                                                                                                                                                                                  |
|-------------------------------|--------------------------------------------------------------------------------------------------------------------------------------------------------------------------------------------------------------------------------------------------------------------------------------------------------------------------------------------------------------------------------------------------------------------------------------------------------------------------------------------------------------------------------------------------------------------------------------------------------------------------------------------------------------------------------------------------------------------------------------------------------------------------------------------------------------------------------------------------------------------------------------------------|
| <b>Static PAT</b>             | Static Port Address Translation. Static PAT is a static address that also maps a local port to a global port. See also <a href="#">Dynamic PAT</a> , <a href="#">NAT</a> .                                                                                                                                                                                                                                                                                                                                                                                                                                                                                                                                                                                                                                                                                                                       |
| <b>subnetmask</b>             | See <a href="#">mask</a> .                                                                                                                                                                                                                                                                                                                                                                                                                                                                                                                                                                                                                                                                                                                                                                                                                                                                       |
| <hr/>                         |                                                                                                                                                                                                                                                                                                                                                                                                                                                                                                                                                                                                                                                                                                                                                                                                                                                                                                  |
| <b>T</b>                      |                                                                                                                                                                                                                                                                                                                                                                                                                                                                                                                                                                                                                                                                                                                                                                                                                                                                                                  |
| <b>TACACS+</b>                | Terminal Access Controller Access Control System Plus. A client-server protocol that supports <a href="#">AAA</a> services, including command authorization. See also <a href="#">AAA</a> , <a href="#">RADIUS</a> .                                                                                                                                                                                                                                                                                                                                                                                                                                                                                                                                                                                                                                                                             |
| <b>TAPI</b>                   | Telephony Application Programming Interface. A programming interface in Microsoft Windows that supports telephony functions.                                                                                                                                                                                                                                                                                                                                                                                                                                                                                                                                                                                                                                                                                                                                                                     |
| <b>TCP</b>                    | Transmission Control Protocol. Connection-oriented transport layer protocol that provides reliable full-duplex data transmission.                                                                                                                                                                                                                                                                                                                                                                                                                                                                                                                                                                                                                                                                                                                                                                |
| <b>TCP Intercept</b>          | With the TCP intercept feature, once the optional embryonic connection limit is reached, and until the embryonic connection count falls below this threshold, every SYN bound for the effected server is intercepted. For each SYN, the security appliance responds on behalf of the server with an empty SYN/ACK segment. The security appliance retains pertinent state information, drops the packet, and waits for the client acknowledgment. If the ACK is received, then a copy of the client SYN segment is sent to the server and the <a href="#">TCP</a> three-way handshake is performed between the security appliance and the server. If this three-way handshake completes, may the connection resume as normal. If the client does not respond during any part of the connection phase, then the security appliance retransmits the necessary segment using exponential back-offs. |
| <b>TDP</b>                    | Tag Distribution Protocol. TDP is used by tag switching devices to distribute, request, and release tag binding information for multiple network layer protocols in a tag switching network. TDP does not replace routing protocols. Instead, it uses information learned from routing protocols to create tag bindings. TDP is also used to open, monitor, and close TDP sessions and to indicate errors that occur during those sessions. TDP operates over a connection-oriented transport layer protocol with guaranteed sequential delivery (such as <a href="#">TCP</a> ). The use of TDP does not preclude the use of other mechanisms to distribute tag binding information, such as piggybacking information on other protocols.                                                                                                                                                        |
| <b>Telnet</b>                 | A terminal emulation protocol for TCP/IP networks such as the <a href="#">Internet</a> . Telnet is a common way to control web servers remotely; however, its security vulnerabilities have led to its replacement by <a href="#">SSH</a> .                                                                                                                                                                                                                                                                                                                                                                                                                                                                                                                                                                                                                                                      |
| <b>TFTP</b>                   | Trivial File Transfer Protocol. TFTP is a simple protocol used to transfer files. It runs on UDP and is explained in depth in RFC 1350.                                                                                                                                                                                                                                                                                                                                                                                                                                                                                                                                                                                                                                                                                                                                                          |
| <b>TID</b>                    | Tunnel Identifier.                                                                                                                                                                                                                                                                                                                                                                                                                                                                                                                                                                                                                                                                                                                                                                                                                                                                               |
| <b>TLS</b>                    | Transport Layer Security. A future IETF protocol to replace <a href="#">SSL</a> .                                                                                                                                                                                                                                                                                                                                                                                                                                                                                                                                                                                                                                                                                                                                                                                                                |
| <b>traffic policing</b>       | The traffic policing feature ensures that no traffic exceeds the maximum rate (bits per second) that you configure, thus ensuring that no one traffic flow can take over the entire resource.                                                                                                                                                                                                                                                                                                                                                                                                                                                                                                                                                                                                                                                                                                    |
| <b>transform set</b>          | See <a href="#">IPSec transform set</a> .                                                                                                                                                                                                                                                                                                                                                                                                                                                                                                                                                                                                                                                                                                                                                                                                                                                        |
| <b>translate, translation</b> | See <a href="#">xlate</a> .                                                                                                                                                                                                                                                                                                                                                                                                                                                                                                                                                                                                                                                                                                                                                                                                                                                                      |



|                                  |                                                                                                                                                                                                                                                                                                                                                                                                  |
|----------------------------------|--------------------------------------------------------------------------------------------------------------------------------------------------------------------------------------------------------------------------------------------------------------------------------------------------------------------------------------------------------------------------------------------------|
| <b>transparent firewall mode</b> | A mode in which the security appliance is not a router hop. You can use transparent firewall mode to simplify your network configuration or to make the security appliance invisible to attackers. You can also use transparent firewall mode to allow traffic through that would otherwise be blocked in <a href="#">routed firewall mode</a> . See also <a href="#">routed firewall mode</a> . |
| <b>transport mode</b>            | An <a href="#">IPSec</a> encryption mode that encrypts only the data portion (payload) of each packet, but leaves the header untouched. Transport mode is less secure than tunnel mode.                                                                                                                                                                                                          |
| <b>TSP</b>                       | TAPI Service Provider. See also <a href="#">TAPI</a> .                                                                                                                                                                                                                                                                                                                                           |
| <b>tunnel mode</b>               | An <a href="#">IPSec</a> encryption mode that encrypts both the header and data portion (payload) of each packet. Tunnel mode is more secure than transport mode.                                                                                                                                                                                                                                |
| <b>tunnel</b>                    | A method of transporting data in one protocol by encapsulating it in another protocol. Tunneling is used for reasons of incompatibility, implementation simplification, or security. For example, a tunnel lets a remote <a href="#">VPN</a> client have encrypted access to a private network.                                                                                                  |
| <b>Turbo ACL</b>                 | Increases <a href="#">ACL</a> lookup speeds by compiling them into a set of lookup tables. Packet headers are used to access the tables in a small, fixed number of lookups, independent of the existing number of <a href="#">ACL</a> entries.                                                                                                                                                  |

---

## U

|                       |                                                                                                                                                                                                                                                                                                                  |
|-----------------------|------------------------------------------------------------------------------------------------------------------------------------------------------------------------------------------------------------------------------------------------------------------------------------------------------------------|
| <b>UDP</b>            | User Datagram Protocol. A connectionless transport layer protocol in the IP protocol stack. UDP is a simple protocol that exchanges datagrams without acknowledgments or guaranteed delivery, which requires other protocols to handle error processing and retransmission. UDP is defined in RFC 768.           |
| <b>UMTS</b>           | Universal Mobile Telecommunication System. An extension of <a href="#">GPRS</a> networks that moves toward an all-IP network by delivering broadband information, including commerce and entertainment services, to mobile users via fixed, wireless, and satellite networks                                     |
| <b>Unicast RPF</b>    | Unicast Reverse Path Forwarding. Unicast RPF guards against spoofing by ensuring that packets have a source IP address that matches the correct source interface according to the routing table.                                                                                                                 |
| <b>URL</b>            | Uniform Resource Locator. A standardized addressing scheme for accessing hypertext documents and other services using a browser. For example, <a href="http://www.cisco.com">http://www.cisco.com</a> .                                                                                                          |
| <b>user EXEC mode</b> | User EXEC mode lets you to see the security appliance settings. The user EXEC mode prompt appears as follows when you first access the security appliance. See also <a href="#">command-specific configuration mode</a> , <a href="#">global configuration mode</a> , and <a href="#">privileged EXEC mode</a> . |
| <b>UTC</b>            | Coordinated Universal Time. The time zone at zero degrees longitude, previously called Greenwich Mean Time (GMT) and Zulu time. UTC replaced GMT in 1967 as the world time standard. UTC is based on an atomic time scale rather than an astronomical time scale.                                                |
| <b>UTRAN</b>          | Universal Terrestrial Radio Access Network. Networking protocol used for implementing wireless networks in UMTS. GTP allows multi-protocol packets to be tunneled through a UMTS/GPRS backbone between a <a href="#">GGSN</a> , an <a href="#">SGSN</a> and the <a href="#">UTRAN</a> .                          |
| <b>UUIE</b>           | User-User Information Element. An element of an <a href="#">H.225</a> packet that identifies the users implicated in the message.                                                                                                                                                                                |



---

**V**

- VLAN** Virtual LAN. A group of devices on one or more LANs that are configured (using management software) so that they can communicate as if they were attached to the same physical network cable, when in fact they are located on a number of different LAN segments. Because VLANs are based on logical instead of physical connections, they are extremely flexible.
- VoIP** Voice over IP. VoIP carries normal voice traffic, such as telephone calls and faxes, over an IP-based network. DSP segments the voice signal into frames, which then are coupled in groups of two and stored in voice packets. These voice packets are transported using IP in compliance with ITU-T specification H.323.
- VPN** Virtual Private Network. A network connection between two peers over the public network that is made private by strict authentication of users and the encryption of all data traffic. You can establish VPNs between clients, such as PCs, or a headend, such as the security appliance.
- virtual firewall** See [security context](#).
- VSA** Vendor-specific attribute. An attribute in a RADIUS packet that is defined by a vendor rather than by RADIUS RFCs. The RADIUS protocol uses IANA-assigned vendor numbers to help identify VSAs. This lets different vendors have VSAs of the same number. The combination of a vendor number and a VSA number makes a VSA unique. For example, the cisco-av-pair VSA is attribute 1 in the set of VSAs related to vendor number 9. Each vendor can define up to 256 VSAs. A RADIUS packet contains any VSAs attribute 26, named Vendor-specific. VSAs are sometimes referred to as subattributes.

---

**W**

- WAN** wide-area network. Data communications network that serves users across a broad geographic area and often uses transmission devices provided by common carriers.
- Websense** A content filtering solution that manages employee access to the Internet. Websense uses a policy engine and a URL database to control user access to websites.
- WEP** Wired Equivalent Privacy. A security protocol for wireless LANs, defined in the IEEE 802.11b standard.
- WINS** Windows Internet Naming Service. A Windows system that determines the IP address associated with a particular network device, also known as “name resolution.” WINS uses a distributed database that is automatically updated with the NetBIOS names of network devices currently available and the IP address assigned to each one. WINS provides a distributed database for registering and querying dynamic NetBIOS names to IP address mapping in a routed network environment. It is the best choice for NetBIOS name resolution in such a routed network because it is designed to solve the problems that occur with name resolution in complex networks.

---

**X**

- X.509** A widely used standard for defining digital certificates. X.509 is actually an ITU recommendation, which means that it has not yet been officially defined or approved for standardized usage.
- xauth** See [IKE Extended Authentication](#).
- xlate** An xlate, also referred to as a translation entry, represents the mapping of one IP address to another, or the mapping of one IP address/port pair to another.



---

## Symbols

- /bits subnet masks [3](#)
- ?
- command string [4](#)
- help [4](#)

---

## Numerics

- 4GE SSM
  - connector types [1](#)
  - fiber [3](#)
  - SFP [3](#)

---

## A

### AAA

- accounting [12](#)
  - addressing, configuring [2](#)
  - authentication
    - network access [1](#)
  - authorization
    - downloadable ACLs [7](#)
    - network access [6](#)
  - local database support [8](#)
  - overview [1](#)
  - performance [1](#)
  - server
    - adding [11](#)
    - types [3](#)
  - support summary [3](#)
  - with web clients [4](#)
- abbreviating commands [3](#)

- accessing the VPN Concentrator using SSL [3](#)
- accessing the VPN Concentrator using TKS1 [3](#)
- access list
  - use in classifying QoS traffic [4](#)
- ACEs
  - logging [17](#)
- ACLs
  - comments [16](#)
  - downloadable [8](#)
  - inbound [1](#)
  - IP address guidelines [3](#)
  - IPsec [20](#)
  - logging [17](#)
  - NAT addresses [3](#)
  - object groups [16](#)
  - outbound [1](#)
  - remarks [16](#)
- Active/Active failover
  - about [10](#)
  - actions [12](#)
  - avoiding duplicate MAC addresses [10, 31](#)
  - command replication [11](#)
  - configuration synchronization [10](#)
  - configuring
    - asymmetric routing support [31](#)
    - cable-based failover [24](#)
    - failover criteria [31](#)
    - failover group preemption [30](#)
    - HTTP replication [30](#)
    - interface monitoring [30](#)
    - interface poll times [30](#)
    - LAN-based failover [26](#)
    - prerequisites [24](#)

- unit poll times [30](#)
  - virtual MAC addresses [31](#)
- device initialization [10, 11](#)
- primary status [10](#)
- secondary status [10](#)
- triggers [12](#)
- Active/Standby failover
  - about [6](#)
  - actions [8](#)
  - command replication [8](#)
  - configuration synchronization [7](#)
  - configuring
    - cable-based [17](#)
    - failover criteria [23](#)
    - HTTP replication [22](#)
    - interface monitoring [22](#)
    - interface poll times [22](#)
    - LAN-based [18](#)
    - prerequisites [16](#)
    - unit poll times [22](#)
    - virtual MAC addresses [23](#)
  - device initialization [7](#)
  - primary unit [7](#)
  - secondary unit [7](#)
  - triggers [8](#)
- Adaptive Security Algorithm (ASA) [2](#)
- address
  - pool, configuring [4](#)
  - range, subnets [4](#)
- admin context
  - changing [5](#)
  - overview [6, 1](#)
- administrative distance
  - about [2](#)
- Advanced Encryption Standard (AES) [3](#)
- AIP SSM configuration [1](#)
- alternate address, ICMP message [15](#)
- application access
  - and e-mail proxy [18](#)
  - and hosts file errors [18](#)
  - and Web Access [18](#)
  - configuring client applications [17](#)
  - enabling cookies on browser [17](#)
  - privileges [17](#)
  - quitting properly [17, 19](#)
  - re-enabling [20](#)
  - setting up on client [17](#)
  - using e-mail [18](#)
  - with IMAP client [18](#)
- Application Access Panel, WebVPN [11](#)
- application inspection
  - configuring [1](#)
- ARP
  - inspection
    - enabling [2](#)
    - overview [1](#)
    - static entry [2](#)
    - test, failover [15](#)
  - spoofing [2](#)
- ASA [4](#)
- ASR
  - See asymmetric routing support*
- asymmetric routing support [31](#)
- attributes
  - user, configuring [33](#)
  - WebVPN, global [5](#)
- authenticating
  - WebVPN users with digital certificates [5](#)
- authentication
  - FTP [2](#)
  - HTTP [2](#)
  - network access [1](#)
  - overview [2](#)
  - Telnet [2](#)
  - web clients [4](#)
- authentication restrictions, WebVPN [4](#)
- authorization
  - network access [6](#)

- overview [2](#)
- Auto-MDI/MDIX [1](#)
- Auto-Update
  - configuring [11 to ??](#)

---

## B

- Baltimore Technologies
  - CA server support [4](#)
- Bandwidth Limiting Traffic stream (BLT) [6](#)
- BGP [6](#)
- bits subnet masks [3](#)
- BPDUs
  - ACL, EtherType [8](#)
- bridge
  - entry timeout [3](#)
  - table
    - See MAC address table
- broadcast Ping test [16](#)

---

## C

- CA
  - CRs. and [2](#)
  - public key cryptography [1](#)
  - revoked certificates [2](#)
  - server support [4](#)
  - supported servers [4](#)
- CA certificate validation, not done in WebVPN [2](#)
- capturing packets [13](#)
- cascading ACLs [15](#)
- certificate authentication
  - e-mail proxy [9](#)
- certificate enrollment protocol [7](#)
- certificate group matching
  - configuring [9](#)
  - rule and policy, creating [10](#)
- Certificate Revocation Lists

- See CRLs
- certification authority
  - See CA
- changing between contexts [5](#)
- Cisco [4](#)
- Cisco IP Phones
  - application inspection [60](#)
  - with DHCP [27](#)
- Class A, B, and C addresses [2](#)
- classification policy, traffic [2](#)
- classifying traffic for QoS [4](#)
- CLI
  - abbreviating commands [3](#)
  - adding comments [5](#)
  - command line editing [3](#)
  - command output paging [5](#)
  - displaying [5](#)
  - help [4](#)
  - paging [5](#)
  - syntax formatting [3](#)
- CLI, WebVPN capture tool [22](#)
- client update, configuring [3](#)
- command prompts [2](#)
- comments
  - ACLs [16](#)
  - configuration [5](#)
- configuration
  - clearing [4](#)
  - comments [5](#)
  - context files [2](#)
  - saving [3](#)
  - text file [4](#)
  - URL for a context [3](#)
  - viewing [3](#)
- configuration mode
  - accessing [2](#)
  - prompt [2](#)
- contexts
  - resource usage [9](#)

- See security contexts
  - conversion error, ICMP message [16](#)
  - cookies, enabling for WebVPN [4](#)
  - crash dump [13](#)
  - crypto map
    - ACLs [20](#)
    - applying to interfaces [20, 7](#)
    - clearing configurations [27](#)
    - creating an entry to use the dynamic crypto map [7](#)
    - definition [12](#)
    - dynamic [24](#)
    - dynamic, creating [6](#)
    - entries [12](#)
    - examples [21](#)
    - policy [13](#)
  - crypto show commands [26](#)
  - CTIQBE [10](#)
  - cut-through proxy [1](#)
- 
- D**
- data flow
    - routed firewall [3](#)
    - transparent firewall [12](#)
  - debug messages [13](#)
  - default
    - DefaultL2Lgroup [1](#)
    - DefaultRAGroup [1](#)
    - DfltGrpPolicy [11](#)
    - group policy [11](#)
    - LAN-to-LAN tunnel group [8](#)
    - queue [2](#)
    - remote access tunnel group, configuring [4](#)
    - tunnel group [11](#)
  - default routes
    - configuring [3](#)
    - defining equal cost routes [3](#)
    - overview [3](#)
  - delay-sensitive traffic, priority [6](#)
  - deny flows, logging [19](#)
  - deny in a crypto map [15](#)
  - DES
    - IKE policy keywords (table) [3](#)
  - DHCP
    - addressing, configuring [3](#)
    - relay [28](#)
    - server
      - Cisco IP Phones [27](#)
      - configuring [25](#)
      - overview [25](#)
    - transparent firewall [6](#)
  - Diffie-Hellman
    - Group 5 [4](#)
    - groups supported [4](#)
  - digital certificates
    - authenticating WebVPN users [5](#)
    - SSL [4](#)
    - WebVPN authentication restrictions [4](#)
  - DMZ, definition [1](#)
  - DNS
    - configuring for WebVPN [5](#)
    - configuring globally [5](#)
    - NAT effect on [34](#)
  - DNS, configuring for WebVPN [7](#)
  - domain name [2](#)
  - dotted decimal subnet masks [3](#)
  - downloadable ACLs
    - configuring [8](#)
    - converting netmask expressions [11](#)
  - DSA keys
    - generating [5](#)
  - duplex, configuring [1](#)
  - dynamic crypto map [24](#)
    - creating [6](#)
    - See also crypto map
  - dynamic NAT
    - See NAT

**E**

echo reply, ICMP message [15](#)

ECMP [2](#)

editing command lines [3](#)

EIGRP [6](#)

e-mail

- closing the Outlook connection [10](#)
- configuring for WebVPN [8](#)
- proxies, WebVPN [9](#)
- WebVPN, configuring [8](#)

e-mail proxy

- and WebVPN [18](#)
- certificate authentication [9](#)

enable

- accessing [2](#)

end-user interface, WebVPN, defining [10](#)

Entrust

- CA server support [4](#)

ESP security protocol [2](#)

established command

- security level requirements [2](#)

Ethernet

- Auto-MDI/MDIX [1](#)
- duplex [1](#)
- speed [1](#)

EtherType

- assigned numbers [8](#)

**F**

failover

- Active/Active, *See* Active/Active failover
- Active/Standby, *See* Active/Standby failover
- configuration file
  - terminal messages [7](#)
- configuring [16](#)
- contexts [6](#)
- debug messages [47](#)
- disabling [46](#)
- displaying commands [44](#)
- encrypting failover communication [35](#)
- Ethernet failover cable [4](#)
- examples
  - Active/Active LAN-based failover [51](#)
  - Active/Standby cable-based failover [48](#)
  - Active/Standby LAN-based failover [49](#)
- failover link [3](#)
- forcing [45](#)
- health monitoring [15](#)
- interface health [15](#)
- interface monitoring [15](#)
- interface tests [15](#)
- licenses [2](#)
- link communications [3](#)
- MAC addresses [7](#)
- monitoring [15](#)
- network tests [15](#)
- overview [1](#)
- primary unit [7](#)
- restoring a failed group [46](#)
- restoring a failed unit [46](#)
- secondary unit [7](#)
- serial cable [4](#)
- SNMP syslog traps [47](#)
- software versions [2](#)
- Stateful Failover, *See* Stateful Failover
- state link [5](#)
- system messages [46](#)
- system requirements [2](#)
- testing [44](#)
- type selection [13](#)
- unit health [15](#)
- verifying the configuration [35](#)

fast path [4](#)

fiber interfaces [3](#)

filtering

- security level requirements [1](#)

servers supported [4](#)  
 show command output [4](#)  
 URLs [4](#)  
 fixup protocol  
   CTIQBE [10](#)  
 FO (failover) license [2](#)  
 FO\_AA license [2](#)  
 fragmentation policy, IPsec [7](#)

---

## G

generating  
   DSA keys [5](#)  
   RSA keys [5](#)  
 global addresses  
   recommendations [34](#)  
   specifying [45](#)  
 global authentication parameters, WebVPN [5](#)  
 global authorization parameters, WebVPN [5](#)  
 global e-mail proxy attributes [9](#)  
 global IPsec SA lifetimes, changing [22](#)  
 global parameters, WebVPN [5](#)  
 global WebVPN attributes, configuring [5](#)  
 group parameters, WebVPN [5](#)  
 group policy  
   configuring [12](#)  
   default [11](#)  
   definition [1, 10](#)

---

## H

H.245  
   troubleshooting [40](#)  
 H.323  
   troubleshooting [39, 41](#)  
 hairpinning [20](#)  
 help, command line [4](#)  
 HMAC hashing method [3](#)

hosts, subnet masks for [3](#)  
 hosts file  
   errors [18](#)  
   WebVPN [19](#)  
 hosts file, reconfiguring [20](#)  
 HSRP [9](#)  
 HTTP  
   authentication [5](#)  
   filtering [4](#)  
 HTTP/HTTPS Web VPN proxy, setting [4](#)  
 HTTPS  
   for WebVPN sessions [3](#)  
 hub-and-spoke [20](#)

---

## I

ICMP  
   testing connectivity [4](#)  
   type numbers [15](#)  
 ID method for ISAKMP peers, determining [6](#)  
 IKE  
   benefits [2](#)  
   creating policies [4](#)  
   See also ISAKMP  
 ILS  
   application inspection [69](#)  
 IM [56](#)  
 inactive keyword  
   ACLs [17](#)  
 inbound ACLs [1](#)  
 information  
   reply, ICMP message [16](#)  
   request, ICMP message [16](#)  
 inside, definition [1](#)  
 inspection engines  
   security level requirements [1](#)  
 Instant Messaging  
   See IM  
 Interfaces



- enabling 2
  - interfaces
    - configuring for remote access 2
    - configuring IPv6 on 2
    - duplex 1
    - enabled status 1,2
    - failover monitoring 15
    - fiber 3
    - global addresses 45
    - IDs 2
    - naming 3
    - SFP 3
    - shared 6
    - speed 1
    - subinterfaces 3
    - viewing monitored interface status 44
  - Internet Security Association and Key Management Protocol
    - See ISAKMP
  - intrusion prevention configuration 1
  - IP addresses
    - classes 2
    - configuring an assignment method 1
    - configuring for VPNs 1
    - configuring local IP address pools 2
    - management, transparent firewall 5
    - overlapping between contexts 4
    - private 2
    - subnet mask 4
  - IPS configuration 1
  - IPSec
    - setting maximum active VPN sessions 3
  - IPsec
    - ACLs 20
    - basic configuration with static crypto maps 23
    - Cisco VPN Client 2
    - configuring 1,11
    - crypto map entries 12
    - fragmentation policy 7
    - over NAT-T, enabling 7
    - over TCP, enabling 8
    - overview 2
    - SA lifetimes, changing 22
    - tunnel 11
    - viewing configuration 26
  - IPv6
    - access lists 4
    - configuring alongside IPv4 6
    - configuring static routes 3
    - configuring the default route 3
  - IPv6 addresses
    - anycast 9
    - command support for 1
    - format 5
    - multicast 8
    - prefixes 10
    - required 10
    - types of 6
    - unicast 6
  - ISAKMP
    - configuring 1,2
    - determining an ID method for peers 6
    - disabling in aggressive mode 6
    - enabling on the outside interface 6,3
    - overview 2
    - policies, configuring 5
    - See also IKE
- 
- ## J
- Java applets
    - filtering 2
- 
- ## K
- Kerberos
    - configuring 11

support 7

## L

LAN-to-LAN tunnel group, configuring 8

latency 1,8

reducing 9

Layer 2

forwarding table

See MAC address table

Layer 2 firewall

See transparent firewall

LDAP

application inspection 69

configuring 11

support 8

licenses

FO 2

FO\_AA 2

UR 2

link up/down test 15

LLQ

See low-latency queue

local user database

adding a user 10

configuring 9

logging in 6

support 8

logging

ACLs 17

login

FTP 2

local user 6

low-latency queue 2

applying 8

## M

MAC addresses, failover 7

MAC address table

entry timeout 3

MAC learning, disabling 4

overview 12

static entry 3

MAC learning, disabling 4

management IP address, transparent firewall 5

man-in-the-middle attack 2

MAPI, configuring 10

mapped interface name 2

mask

reply, ICMP message 16

request, ICMP message 16

matching

command criteria for QoS 5

matching, certificate group 9

maximum active IPSec VPN sessions, setting 3

MD5

IKE policy keywords (table) 3

message-of-the-day banner 16

MIBs 2

Microsoft Windows 2000 CA

supported 4

mobile redirection, ICMP message 16

mode

context 10

monitoring

failover 15

OSPF 16

SNMP 1

More prompt 5

MPLS

LDP 8

router-id 8

TDP 8

multicast traffic 9

multiple mode, enabling [10](#)

## N

N2H2 filtering server

supported [4](#)

URL for website [4](#)

naming an interface [3](#)

NAT

bypassing NAT

configuration [49](#)

overview [29](#)

DNS [34](#)

dynamic NAT

configuring [43](#)

implementation [37](#)

overview [25](#)

examples [53](#)

exemption from NAT

configuration [52](#)

overview [29](#)

identity NAT

configuration [49](#)

overview [29](#)

NAT ID [37](#)

order of statements [34](#)

overlapping addresses [53](#)

overview [21, 22](#)

PAT

configuring [43](#)

implementation [37](#)

overview [26](#)

policy NAT

overview [29](#)

port redirection [55](#)

RCP not supported with [69](#)

same security level [33](#)

security level requirements [2](#)

static NAT

configuring [46](#)

overview [27](#)

static PAT

configuring [47](#)

overview [27](#)

transparent firewall [11](#)

types [25](#)

NAT-T

enabling IPsec over NAT-T [7](#)

using [7](#)

Netscape CMS

CA server support [4](#)

Network Activity test [15](#)

Network Address Translation

See NAT

NTLM support [7](#)

NT server

configuring [11](#)

support [7](#)

## O

object groups

nesting [14](#)

removing [16](#)

open ports [14](#)

OSPF

area authentication [11](#)

area MD5 authentication [11](#)

area parameters [11](#)

authentication key [9](#)

cost [9](#)

dead interval [9](#)

default route [14](#)

displaying update packet pacing [15](#)

enabling [5](#)

hello interval [9](#)

interface parameters [9](#)

link-state advertisement [4](#)

- logging neighbor states [15](#)
- MD5 authentication [9](#)
- monitoring [16](#)
- NSSA [12](#)
- overview [4](#)
- packet pacing [15](#)
- processes [4](#)
- redistributing routes [5](#)
- route calculation timers [14](#)
- route map [7](#)
- route summarization [13](#)
- stub area [11](#)
- summary route cost [11](#)
- outbound ACLs [1](#)
- Outlook connection, closing [10](#)
- Outlook Exchange proxy, configuring [10](#)
- Outlook Web Access (OWA) and WebVPN [18](#)
- outside, definition [1](#)

---

## P

- packet
  - capture [13](#)
  - classifier [3](#)
  - flow, transparent firewall [12](#)
- packet flow
  - routed firewall [3](#)
- paging screen displays [5](#)
- parameter problem, ICMP message [15](#)
- password
  - user, setting [32](#)
  - WebVPN [12](#)
- PAT (Port Address Translation)
  - limitations [53](#)
  - See also NAT
- peers
  - alerting before disconnecting [9](#)
  - ISAKMP, determining ID method [6](#)
- permit in a crypto map [15](#)
- ping
  - See ICMP
- PKI protocol [7](#)
- policing
  - flow within a tunnel [4](#)
  - QoS [2](#)
  - strict [6](#)
  - verifying the configuration [13](#)
- policy, QoS [1](#)
- policy-map
  - defining for QoS [5](#)
  - use in QoS [7](#)
- policy NAT
  - dynamic, configuring [44](#)
  - overview [29](#)
  - static, configuring [46](#)
  - static PAT, configuring [48](#)
- pools
  - address
    - global NAT [45](#)
- pools, address
  - DHCP [26](#)
- PORT command, FTP [23](#)
- Port Forwarding
  - configuring client applications [17](#)
- ports
  - open on device [14](#)
  - redirection, NAT [55](#)
- primary unit, failover
  - overview [7](#)
- priority queue
  - configuration for an interface, viewing [13](#)
  - configuring [8](#)
  - for delay-sensitive traffic [6](#)
  - sizing [8](#)
- private networks [2](#)
- privileged mode
  - accessing [2](#)
  - prompt [2](#)

privilege level  
 user, setting [32](#)

prompts  
 command [2](#)  
 more [5](#)

protocol numbers and literal values [11](#)

proxy  
 See e-mail proxy

proxy servers  
 SIP and [55](#)

public key cryptography [1](#)

---

## Q

QoS  
 (definition) [1](#)  
 action [3](#)  
 classifying traffic [4](#)  
 concepts [2](#)  
 defining a policy map [5](#)  
 match command criteria [5](#)  
 overview [1](#)  
 policies [1](#)  
 policing [2](#)  
 policy, configuring [3](#)  
 statistics [13](#)  
 traffic class [3](#)  
 viewing statistics [13,14](#)

Quality of Service, See QoS

question mark  
 command string [4](#)  
 help [4](#)

queue  
 latency, reducing [9](#)  
 limit [8](#)  
 priority, configuring [6,8](#)

---

## R

RADIUS  
 configuring a server [11](#)  
 downloadable ACLs [8](#)  
 network access authentication [3](#)  
 network access authorization [7](#)  
 support [4](#)

RAS  
 H.323 troubleshooting [40](#)

rate limiting [6](#)

reboot, waiting until active sessions end [8](#)

redirect, ICMP message [15](#)

redundancy, in site-to-site VPNs, using crypto maps [26](#)

Registration Authority  
 description [2](#)

reloading  
 context [7](#)

remarks [16](#)

remote access  
 configuration summary [1](#)  
 tunnel group, configuring [4](#)  
 tunnel group, configuring default [4](#)  
 user  
 adding [4](#)  
 VPN, configuring [1](#)

resource usage [9](#)  
 resource types [9](#)

revoked certificates [2](#)

RIP  
 default route updates [17](#)  
 enabling [17](#)  
 overview [17](#)  
 passive [17](#)

router  
 advertisement, ICMP message [15](#)  
 solicitation, ICMP message [15](#)

routes  
 about default [3](#)

- about static [1](#)
- configuring default routes [3](#)
- configuring IPv6 default [3](#)
- configuring IPv6 static [3](#)
- configuring static routes [2](#)
- routing
  - OSPF [17](#)
  - other protocols [5](#)
  - RIP [18](#)
- RS-232 cable
  - See failover [4](#)
- RSA
  - KEON
    - CA server support [4](#)
  - keys
    - generating [5,2](#)
  - signatures
    - IKE authentication method [2](#)

---

## S

- same security level communication
  - NAT [33](#)
- SAs
  - lifetimes [22](#)
- SDI
  - configuring [11](#)
  - support [6](#)
- secondary unit, failover [7](#)
- security association
  - clearing [27](#)
  - See also SAs
- security contexts
  - adding [2](#)
  - admin context
    - changing [5](#)
    - overview [6,1](#)
  - changing between [5](#)
  - classifier [3](#)

- configuration
  - files [2](#)
  - URL, changing [6](#)
  - URL, setting [3](#)
- logging in [10](#)
- mapped interface name [2](#)
- multiple mode, enabling [10](#)
- nesting or cascading [9](#)
- overview [1](#)
- prompt [2](#)
- reloading [7](#)
- removing [5](#)
- unsupported features [2](#)
- VLAN allocation [2](#)
- See ASA
- serial cable
  - See failover
- session management path [4](#)
- SHA
  - IKE policy keywords (table) [3](#)
- shared VLANs [6](#)
- show command, filtering output [4](#)
- single mode
  - backing up configuration [10](#)
  - configuration [10](#)
  - enabling [10](#)
  - restoring [11](#)
- SIP
  - troubleshooting [59](#)
- site-to-site VPNs, redundancy [26](#)
- sizing the priority queue [8](#)
- SNMP
  - MIBs [2](#)
  - overview [1](#)
  - traps [2](#)
- source quench, ICMP message [15](#)
- speed, configuring [1](#)
- SSH
  - authentication [5](#)

- concurrent connections [2](#)
  - login [3](#)
  - RSA key [2](#)
  - username [3](#)
  - SSL
    - certificate [4](#)
    - used to access the VPN Concentrator [3](#)
  - SSL/TLS encryption protocols, configuring [4](#)
  - SSL/TLS encryption protocols, WebVPN [4](#)
  - SSM configuration
    - AIP SSM [1](#)
  - startup configuration [2](#)
  - Stateful Failover
    - overview [14](#)
    - state information [14](#)
    - state link [5](#)
    - statistics [38, 42](#)
  - stateful inspection [4](#)
  - state information [14](#)
  - state link [5](#)
  - static ARP entry [2](#)
  - static bridge entry [3](#)
  - static NAT
    - See NAT
  - static PAT
    - See NAT
  - static routes
    - configuring [2](#)
    - overview [1](#)
  - statistics
    - QoS [13](#)
    - viewing QoS [13](#)
  - stealth firewall
    - See transparent firewall
  - stub multicast routing
    - See SMR
  - subcommand mode prompt [2](#)
  - subinterfaces
    - adding [3](#)
  - subnet masks
    - /bits [3](#)
    - address range [4](#)
    - determining [3](#)
    - dotted decimal [3](#)
    - number of hosts [3](#)
    - overview [2](#)
  - Sun Microsystems Java™ Runtime Environment (JRE) and WebVPN [17](#)
  - syntax formatting [3](#)
  - system configuration
    - network settings [2](#)
    - overview [6, 1](#)
- 
- T**
- TACACS+
    - configuring a server [11](#)
    - network access authorization [6](#)
    - support [5](#)
  - tail drop [8](#)
  - TCP
    - ports and literal values [11](#)
    - sequence number randomization
      - disabling
        - routed mode [44](#)
  - Telnet
    - authentication [5](#)
    - concurrent connections [1](#)
  - testing configuration [4](#)
  - time exceeded, ICMP message [15](#)
  - time ranges
    - ACLs [17](#)
  - timestamp
    - reply, ICMP message [16](#)
    - request, ICMP message [16](#)
  - TLS1
    - used to access the VPN Concentrator [3](#)
  - toolbar, floating, WebVPN [12](#)

- traffic
    - classifying for QoS [4](#)
  - traffic class, QoS [3](#)
  - traffic flow
    - routed firewall [3](#)
    - transparent firewall [12](#)
  - traffic policing
    - verifying the configuration [13](#)
  - Transform [12](#)
  - transform set
    - creating [4](#)
    - definition [12](#)
  - transmit queue ring limit [8](#)
  - transparent firewall
    - ARP inspection
      - enabling [2](#)
      - overview [1](#)
      - static entry [2](#)
    - data flow [12](#)
    - DHCP packets, allowing [6](#)
    - guidelines [10](#)
    - HSRP [9](#)
    - MAC address timeout [3](#)
    - MAC learning, disabling [4](#)
    - management IP address [5](#)
    - multicast traffic [9](#)
    - NAT [11](#)
    - overview [9](#)
    - packet handling [5](#)
    - static bridge entry [3](#)
    - VRRP [9](#)
  - traps, SNMP [2](#)
  - troubleshooting
    - H.323 [39](#)
    - H.323 RAS [40](#)
    - SIP [59](#)
  - trustpoint [3](#)
  - tunnel
    - IPsec [11](#)
    - security appliance as a tunnel endpoint [1](#)
  - tunnel group
    - configuring [4](#)
    - default [11,1](#)
      - LAN-to-LAN, configuring [8](#)
      - remote access, configuring [4](#)
    - definition [1,2](#)
    - IPSec parameters [3](#)
    - LAN-to-LAN, configuring [8](#)
    - remote access
      - configuring [5](#)
      - remote access, configuring [4](#)
  - tunneling
    - overview [1](#)
  - tx-ring-limit [8](#)
- 
- ## U
- UDP
    - connection state information [4](#)
    - ports and literal values [11](#)
  - unprivileged mode
    - prompt [2](#)
  - unreachable, ICMP message [15](#)
  - UR (unrestricted) license [2](#)
  - URL
    - context configuration, changing [6](#)
    - context configuration, setting [3](#)
  - URLs
    - filtering [4](#)
    - filtering, configuration [7](#)
  - URLs, WebVPN capture tool [22](#)
  - user
    - attributes, configuring [33](#)
    - configuring [31](#)
    - configuring specific [32](#)
    - definition [1](#)
    - password, setting [32](#)
    - privilege level, setting [32](#)



- remote access
  - adding [4](#)
- username
  - WebVPN [12](#)
- U-turn [20](#)

---

## V

- verifying the traffic-policing configuration [13](#)
- VeriSign
  - configuring CAs, example [4](#)
- viewing
  - RMS [12](#)
- viewing QoS statistics [13, 14](#)
- virtual firewalls
  - See security contexts
- VLANs [3](#)
  - allocating to a context [2](#)
  - mapped interface name [2](#)
  - shared [6](#)
- VoIP
  - proxy servers [55](#)
  - troubleshooting [39](#)
- VPN
  - parameters, general, setting [1](#)
  - setting maximum number of IPSec sessions [3](#)
- VPN Client, IPsec attributes [2](#)
- VRRP [9](#)

---

## W

- web browsing with WebVPN [15](#)
- web clients
  - secure authentication [4](#)
- web e-Mail (Outlook Web Access)
  - Outlook Web Access [10](#)
- WebVPN
  - assigning users to group policies [7](#)

- authenticating with digital certificates [5](#)
- CA certificate validation not done [2](#)
- capture tool [22](#)
- client application requirements [13](#)
- client requirements [13](#)
  - for file management [16](#)
  - for network browsing [16](#)
  - for port forwarding [17](#)
  - for using applications [17](#)
  - for web browsing [15](#)
  - start-up [14](#)
- configuring
  - DNS globally [7](#)
  - e-mail [8](#)
- configuring DNS globally [5](#)
- cookies [4](#)
- defining the end-user interface [10](#)
- definition [1](#)
- digital certificate authentication restrictions [4](#)
- e-mail [8](#)
- e-mail proxies [9](#)
- enable cookies for [17](#)
- end user set-up [10](#)
- establishing a session [3](#)
- floating toolbar [12](#)
- global and group settings [5](#)
- global attributes [5](#)
- global authentication and authorization settings [5](#)
- global DNS settings [5](#)
- group policy attributes, configuring [8](#)
- hosts file [19](#)
- hosts files, reconfiguring [20](#)
- HTTP/HTTPS proxy, setting [4](#)
- printing and [14](#)
- remote system configuration and end-user requirements [14](#)
- security precautions
  - security
    - WebVPN [2](#)

- security tips [13](#)
- setting HTTP/HTTPS proxy [3](#)
- SSL/TLS encryption protocols [4](#)
- supported applications [13](#)
- supported browsers [14](#)
- supported types of Internet connections [14](#)
- troubleshooting [18](#)
- unsupported features [2](#)
- URL [14](#)
- use of HTTPS [3](#)
- username and password required [14](#)
- usernames and passwords [12](#)
- use suggestions [10, 13](#)
- WebVPN, Application Access Panel [11](#)
- webvpn mode [6](#)